

**Model GX20/GP20/GM10,
UT52A/UT32A,
UPM100**

**920 MHz Wireless Communication,
MH920 Console International**

Introduction

Thank you for purchasing the SMARTDAC+ GX20/GP20 (hereafter referred to as the GX, GP), GM10 (hereafter referred to as the GM), UTAdvanced UT52A/UT32A with the /MDL option (hereafter referred to as the UT) or UPM100 (hereafter referred to as the UPM). This manual explains how to use the GX/GP/GM's 920 MHz wireless communication (/CM2, /CS2, /CM3, /CS3 options), the UT's 920 MHz wireless communication (suffix code Type 3: B or C) and the UPM's 920 MHz wireless communication (suffix code Optional communication function: C). For details on the various settings and operating details of the GX/GP/GM/UT/UPM/GX70SM (Wireless Input Unit) and how to use it, read this manual together with the following manuals.

Model	Manual Title	Manual No.	Description
GX/GP	Model GX10/GX20/GP10/GP20 Paperless Recorder First Step Guide	IM 04L51B01-02EN	Describes the basic operation, installation, and wiring of the GX/GP.
	GX20 (/CM2 and /CM3 options) GM10 (/CM2, /CS2, /CM3 and /CS3 options) 920MHz Wireless Communication First Step Guide	IM 04L51B01-42EN	Describes the 920MHz Wireless Communication.
	Model GX10/GX20/GP10/GP20 Paperless Recorder User's Manual	IM 04L51B01-01EN	Describes the various settings and operating details of the GX/GP.
GM	Data Acquisition System GM First Step Guide	IM 04L55B01-02EN	Describes the basic operation, installation, and wiring of the GM.
	GX20 (/CM2 option) GM10 (/CM2 and /CS2 options) 920MHz Wireless Communication First Step Guide	IM 04L51B01-42EN	Describes the 920MHz Wireless Communication.
	Data Acquisition System GM User's Manual	IM 04L55B01-01EN	Describes the various settings and operating details of the GM.
UT	UT55A/UT52A Digital Indicating Controller Operation Guide for Single-loop Control (for Standard code model)	IM 05P01C81-11EN	Describes the installation and wiring of the UT.
	UT55A/UT52A Digital Indicating Controller User's Manual	IM 05P01C31-01EN	Describes the detailed settings and all other functions of the UT.
	UT35A/UT32A Digital Indicating Controller Operation Guide (for Standard code model)	IM 05P01D81-11EN	Describes the installation and wiring of the UT.
	UT35A/UT32A Digital Indicating Controller User's Manual	IM 05P01D31-01EN	Describes the detailed settings and all other functions of the UT.
	UT52A/MDL, UT32A/MDL Digital Indicating Controller (DIN Rail Mounting and Wireless Communication Type) Operation Guide	IM 05P01C81-41EN	Describes the 920MHz Wireless Communication.
UPM	UPM100 Universal Power Monitor User's Manual	IM 77C01H01-43EN	Describes the installation and wiring of the UPM.
GX70SM	Model GX70SM Wireless Input Unit First Step Guide (Notes about Using This Product)	IM 04L57B01-02EN	Describes the precaution on the use, installation, and wiring of the GX70SM.
	Model GX70SM Wireless Input Unit User's Manual	IM 04L57B01-01EN	Describes the configuration, management, and maintenance of the GX70SM and the wireless input unit function of the GX20 (/CM2)/GP20 (/CM2) Paperless Recorders and GM10 (/CM2) Data Acquisition Unit.

The GX/GP/GM's 920 MHz wireless communication (/CM2 and /CS2 options) can only be used in the US.

The UT's 920 MHz wireless communication (suffix code Type 3: B) can only be used in the US.

The GX70SM's 920 MHz wireless communication (suffix code Area: A) can only be used in the US.

The GX/GP/GM's 920 MHz wireless communication (/CM3 and /CS3 options) can only be used in the Republic of Korea.

The UT's 920 MHz wireless communication (suffix code Type 3: C) can only be used in the Republic of Korea.

The UPM's 920 MHz wireless communication (suffix code Optional communication function: C) can only be used in the Republic of Korea.

The GX70SM's 920 MHz wireless communication (suffix code Area: K) can only be used in the Republic of Korea.

To ensure correct use, please read this manual thoroughly before beginning operation. The following manuals are provided for the GX/GM/UT/UPM.

● Paper Manuals

Model	Manual Title	Manual No.	Description
GX/GP	Model GX10/GX20/GP10/GP20 Paperless Recorder First Step Guide	IM 04L51B01-02EN	Describes the basic operations of the GX/GP.
GM	Data Acquisition System GM First Step Guide	IM 04L55B01-02EN	Describes the basic operations of the GM.
GX/GP/ GM	GX20 (/CM2 option) GM10 (/CM2 and /CS2 options) 920MHz Wireless Communication First Step Guide	IM 04L51B01-42EN	Describes the 920MHz Wireless Communication.
UT	UT55A/MDL, UT52A/MDL Digital Indicating Controller (DIN Rail Mounting Type) Operation Guide for Single-loop Control	IM 05P01C81-11EN	Describes the installation and wiring of the UT.
	UT35A/MDL, UT32A/MDL Digital Indicating Controller (DIN Rail Mounting Type) Operation Guide	IM 05P01D81-11EN	Describes the installation and wiring of the UT.
UT	UT52A/MDL, UT32A/MDL Digital Indicating Controller (DIN Rail Mounting and Wireless Communication Type) Operation Guide	IM 05P01C81-41EN	Describes the 920MHz Wireless Communication.
GX70SM	Model GX70SM Wireless Input Unit First Step Guide (Notes about Using This Product)	IM 04L57B01-02EN	Describes the precaution on the use, installation, and wiring of the GX70SM.

● SMARTDAC+ Downloadable Electronic Manuals

You can download the latest manuals from the following website.

www.smartdacplus.com/manual/en/

Model	Manual Title	Manual No.	Description
GX/GP	Model GX10/GX20/GP10/GP20 Paperless Recorder First Step Guide	IM 04L51B01-02EN	This is the electronic version of the paper manual.
	Model GX10/GX20/GP10/GP20 Paperless Recorder User's Manual	IM 04L51B01-01EN	Describes how to use the GX/GP. The communication control commands and some of the options are excluded.
	Model GX10/GX20/GP10/GP20 Advanced Security Function (/AS) User's Manual	IM 04L51B01-05EN	Describes how to use the advanced security function (/AS option).
GM	Data Acquisition System GM First Step Guide	IM 04L55B01-02EN	This is the electronic version of the paper manual.
	Data Acquisition System GM User's Manual	IM 04L55B01-01EN	Describes how to use the GM. The communication control commands and some of the options are excluded.
	Data Acquisition System GM Advanced Security Function (/AS) User's Manual	IM 04L55B01-05EN	Describes how to use the advanced security function (/AS option).
GX/GP GM	GX20 (/CM2 option) GM10 (/CM2 and /CS2 options) 920MHz Wireless Communication First Step Guide	IM 04L51B01-42EN	Describes the 920MHz Wireless Communication.
	Model GX10/GX20/GP10/GP20/GM10 Communication Command User's Manual	IM 04L51B01-17EN	Describes how to use command control communication functions.
	SMARTDAC+ STANDARD Universal Viewer User's Manual	IM 04L61B01-01EN	Describes how to use Universal Viewer, which is a software that displays GX/GP/GM measurement data files.
	SMARTDAC+ STANDARD Hardware Configurator User's Manual	IM 04L61B01-02EN	Describes how to use the PC software for creating setting parameters for various GX/GP/GM functions.
	Model GX10/GX20/GP10/GP20/GM10 Multi-batch Function (/BT) User's Manual	IM 04L51B01-03EN	Describes how to use the multi batch function (/BT option).
GX/GP GM	Model GX10/GX20/GP10/GP20/GM10 Log Scale (/LG) User's Manual	IM 04L51B01-06EN	Describes how to use the log scale (/LG option).
	Model GX10/GX20/GP10/GP20/GM10 EtherNet/IP Communication (/E1) User's Manual	IM 04L51B01-18EN	Describes how to use the communication functions through the EtherNet/IP (/E1 option).
	Model GX10/GX20/GP10/GP20/GM10 WT Communication (/E2) User's Manual	IM 04L51B01-19EN	Describes how to use WT communication (/E2 option).
	Model GX10/GX20/GP10/GP20/GM10 OPC-UA Server (/E3) User's Manual	IM 04L51B01-20EN	Describes how to use the OPC-UA server function (/E3 option).
	Model GX10/GX20/GP10/GP20/GM10 SLMP Communication (/E4) User's Manual	IM 04L51B01-21EN	Describes how to use SLMP communication function (/E4 option).
	Model GX10/GX20/GP10/GP20/GM10/GX90NW PROFINET Communication User's Manual	IM 04L51B01-22EN	Describes how to use PROFINET communication function.
GX/GP	Model GX20/GM10 920 MHz wireless communication (/CM2 and /CS2) User's Manual	IM 04L51B01-41EN	Describes how to use the 920 MHz wireless communication (/CM2, /CS2 option).
	DXA170 DAQStudio User's Manual	IM 04L41B01-62EN	Describes how to create custom displays (/CG option).

Continued on next page

Model	Manual Title	Manual No.	Description
GX70SM	Model GX70SM Wireless Input Unit First Step Guide (Notes about Using This Product)	IM 04L57B01-02EN	This is the electronic version of the paper manual.
	Model GX70SM Wireless Input Unit User's Manual	IM 04L57B01-01EN	Describes the configuration, management, and maintenance of the GX70SM and the wireless input unit function of the GX20 (/CM2)/GP20 (/CM2) Paperless Recorders and GM10 (/CM2) Data Acquisition Unit.

● UTAdvanced Downloadable Electronic Manuals

You can download the latest manuals from the following website.

<http://www.yokogawa.com/ns/ut/im/>

Model	Manual Title	Manual No.	Description
UT	UT55A/MDL, UT52A/MDL Controller (DIN Rail Mounting Type) Operation Guide for Single-loop Control	IM 05P01C81-11EN	Describes the installation and wiring of the UT.
	UT35A/MDL, UT32A/MDL Controller (DIN Rail Mounting Type) Operation Guide	IM 05P01D81-11EN	Describes the installation and wiring of the UT.
	UT52A/MDL, UT32A/MDL Digital Indicating Controller (DIN Rail Mounting and Wireless Communication Type) Operation Guide	IM 05P01C81-41EN	Describes the 920MHz Wireless Communication.
	UT55A/UT52A Digital Indicating Controller User's Manual	IM 05P01C31-01EN	Describes the detailed settings and all other functions of the UT.
	UT35A/UT32A Digital Indicating Controller User's Manual	IM 05P01D31-01EN	Describes the detailed settings and all other functions of the UT.
	UTAdvanced Series Communication Interface (RS-485, Ethernet) User's Manual	IM 05P07A01-01EN	Describes how to use Ethernet communication and serial communication.
	LL50A Parameter Setting Software with Ladder Program Building Function and Network Profile Creating Function Installation Manual	IM 05P05A01-01EN	Describes how to install and uninstall LL50A.
	LL50A Parameter Setting Software with Ladder Program Building Function and Network Profile Creating Function User's Manual	IM 05P05A01-02EN	Describes how to use the LL50A, the ladder sequence function, inter-device communication function, network profile creating function, and so on.

● Power Monitor Downloadable Electronic Manuals

You can download the latest manuals from the following website.

<http://www.yokogawa.com/ns/powercert/im/>

Model	Manual Title	Manual No.	Description
UPM	Model UPM100 Universal Power Monitor User's Manual	IM 77C01H01-43EN	Describes the installation and wiring of the UPM.
	Model UPM100, UPM101 Universal Power Monitor Communication Functions User's Manual	IM 77C01H01-10EN	Describes how to use serial communication.

Notes

- The contents of this manual are subject to change without prior notice as a result of continuing improvements to the instrument's performance and functions.
- Every effort has been made in the preparation of this manual to ensure the accuracy of its contents. However, should you have any questions or find any errors, please contact your nearest YOKOGAWA dealer.
- Copying or reproducing all or any part of the contents of this manual without YOKOGAWA's permission is strictly prohibited.

QR code

The product may have a QR Code pasted for efficient plant maintenance work and asset information management.

It enables confirming the specifications of purchased products and user's manuals.

For more details, please refer to the following URL.

<https://www.yokogawa.com/qr-code>

QR Code is a registered trademark of DENSO WAVE INCORPORATED.

Trademarks

- SMARTDAC+ is registered trademark or trademark of Yokogawa Electric Corporation.
- Microsoft and Windows are registered trademarks or trademarks of Microsoft Corporation in the United States and other countries.
- Adobe and Acrobat are registered trademarks or trademarks of Adobe Systems Incorporated.
- Kerberos is a trademark of Massachusetts Institute of Technology (MIT).
- RC4 is a registered trademark of RSA Security Inc. in the United States and other countries.
- Company and product names that appear in this manual are registered trademarks or trademarks of their respective holders.
- The company and product names used in this manual are not accompanied by the registered trademark or trademark symbols (® and ™).

About the Usage of Open Source Software (GX/GP/GM)

This product uses open source software.

For details on using open source software, see *Regarding the Downloading and Installing for the Software, Manuals and Labels/About the Usage of Open Source Software* (IM 04L61B01-11EN).

Revisions

1st Edition: November 2017 6th Edition: May 2023
2nd Edition: June 2018
3rd Edition: March 2019
4th Edition: November 2019
5th Edition: May 2020

How to Use This Manual

Recorder Version Described in This Manual

In the case of the GX/GP/GM10, the contents of this manual apply to the GX/GP/GM10 with the following release numbers (see the STYLE S number) and later and style numbers (see the STYLE H number) and later.

Model	Release Number	Style Number
GX10	5	5
GP10		
GX20		3
GP20		4
GM10		1

In the case of the UT, the contents of this manual apply to the UT52A/UT32A with the following release numbers and style numbers.

Model	Release Number	Style Number
UT52A	1	11
UT32A	1	11

In the case of the UPM, the contents of this manual apply to the UPM100 with the following release numbers and style numbers.

Model	Release Number	Style Number
UPM100	1	2.0

What This Manual Explains

This manual mainly describes how to use the 920 MHz wireless communication. For details on other settings and operating procedures, see the *Model GX10/GX20/GP10/GP20 Paperless Recorder User's Manual* (IM 04L51B01-01EN), *Data Acquisition System GM User's Manual* (IM 04L55B01-01EN), *UT55A/UT52A Digital Indicating Controller User's Manual* (IM 05P01C31-01EN), *UT35A/UT32A Digital Indicating Controller User's Manual* (IM 05P01D31-01EN), or *UPM100 Universal Power Monitor User's Manual* (IM 77C01H01-43EN). For details on the GX/GP/GM communication commands, see the *Model GX10/GX20/GP10/GP20/GM10 Communication Command User's Manual* (IM 04L51B01-17EN).

The GX20/GP20/GM10 standard type and large memory type are distinguished using the following notations.

- Standard type: GX20-1/GP20-1/GM10-1
- Large memory type: GX20-2/GP20-2/GM10-2

The following terms are used for references to other manuals:

Notation	Description
GX/GP User's Manual	Model GX10/GX20/GP10/GP20 Paperless Recorder User's Manual Refers to the IM 04L51B01-01EN.
GX/GP First Step Guide	Model GX10/GX20/GP10/GP20 Paperless Recorder First Step Guide Refers to the IM 04L51B01-02EN.
GM User's Manual	GM Data Acquisition System User's Manual Refers to the IM 04L55B01-01EN.
GM First Step Guide	GM Data Acquisition System First Step Guide Refers to the IM 04L55B01-02EN.
Communication Command Manual	Model GX10/GX20/GP10/GP20/GM10 Communication Command User's Manual Refers to the IM 04L51B01-17EN.
UT52A User's Manual	UT55A/UT52A Digital Indicating Controller User's Manual Refers to the IM 05P01C31-01EN.
UT52A Operation Guide	UT55A/MDL, UT52A/MDL Controller (DIN rail mounting type) Operation Guide for Single-loop Control Refers to the IM 05P01C31-11EN.
UT32A User's Manual	UT35A/UT32A Digital Indicating Controller User's Manual Refers to the IM 05P01D31-01EN.

Continued on next page

Notation	Description
UT32A Operation Guide	UT35A/MDL, UT32A/MDL Controller (DIN rail mounting type) Operation Guide for Single-loop Control Refers to the IM 05P01D31-11EN.
UPM100 User's Manual	UPM100 Universal Power Monitor User's Manual Refers to the IM 77C01H01-43EN

This manual uses the following terms.

Term	Description
Wireless device	Refers to this device, which is equipped with wireless communication hardware.
Maintenance console*	Refers to MH920 Console International.
Wireless communication module*	Refers to the wireless communication hardware of this device. It specifically refers to the wireless communication coordinator module and wireless communication router module.
Coordinator	Refers to the master device. It refers to this device equipped with the wireless communication coordinator module.
Router	Refers to the router. It refers to this device equipped with the wireless communication coordinator module.
Wireless sensor	Refers to wireless input unit GX70SM etc.

* The firmware version of the wireless communication module covered in this manual is v4.x. The corresponding maintenance console version is v4.x.

Conventions Used in This Manual

Unit	
K	Denotes 1024. Example: 768K (file size)
k	Denotes 1000.

Notes



Warning

CAUTION

Note

Improper handling or use can lead to injury to the user or damage to the instrument. This symbol appears on the instrument to indicate that the user must refer to the user's manual for special instructions. The same symbol appears in the corresponding place in the user's manual to identify those instructions. In the manual, the symbol is used in conjunction with the word "WARNING" or "CAUTION."

Calls attention to actions or conditions that could cause serious or fatal injury to the user, and precautions that can be taken to prevent such occurrences.

Calls attention to actions or conditions that could cause light injury to the user or cause damage to the instrument or user's data, and precautions that can be taken to prevent such occurrences.

Calls attention to information that is important for the proper operation of the instrument.

Reference Item



Reference to related operation or explanation is indicated after this mark.

Example:▶ section 4.1

Conventions Used in the Procedural Explanations

Bold characters Denotes key or character strings that appear on the screen.

Example: **Voltage**

A|a|#|1

Indicates the character types that can be used.

A uppercase alphabet, **a** lowercase alphabet, **#** symbol,

1 numbers

Procedure

Carry out the procedure according to the step numbers. All procedures are written with inexperienced users in mind; depending on the operation, not all steps need to be taken.

Explanation

Explanation gives information such as limitations related the procedure.

Path

Indicates the setup screen and explains the settings.

Description

Revision History

Edition	Model	Product	Description
1	GX/GM	Release number 4 (Version 4.01)	New edition
		Style number 1	
	UT	Release number 1 Style number 11	
2	GX/GP	Release number 4 (Version 4.02)	Addition of GP20 Supports GX70SM
		Style number 2	
	GM	Release number 4 (Version 4.02) Style number 1	
3	GX/GP	Release number 4 (Version 4.06)	Supports / CM3 option
		Style number 2	
	GM	Release number 4 (Version 4.06) Style number 1	Supports / CM3 and / CS3 options
	UT	Release number 1 Style number 11	Supports suffix code Type: C
	UPM	Release number 1 Style number 2.0	Addition of UPM100
4	---	---	Addition of RSSI measurement for MH920 Console International (Version 4.4)
5	GX/GP	Release number 4 (Version 4.08)	Support for style up (H: 3 (GX10/GX20/GP10), H: 4 (GP20)) .
		Style number 3, 4	
	GM	Release number 4 (Version 4.07) Style number 1	---
6	GX/GP	Release number 5 (Version 5.02)	Support for style up (H: 5 (GX10/GP10)) .
		Style number 5 (GX10/GP10), 4 (GP20), 3 (GX20)	
	GM	Release number 5 (Version 5.02) Style number 1	---

Blank

Contents

Introduction.....	i
Notes	iii
QR code	iii
Trademarks	iii
Revisions	iv
How to Use This Manual.....	v
Recorder Version Described in This Manual	v
What This Manual Explains	v
Conventions Used in This Manual.....	vi
Revision History.....	vii

Chapter 1 Overview and Specifications

1.1 Overview	1-1
1.2 Specifications	1-2
1.2.1 Wireless Communication Function.....	1-2

Chapter 2 Configuration and Connection

2.1 Configuration.....	2-1
2.1.1 Preparation, Configuration, and Operation Check	2-1
2.1.2 Default Settings.....	2-3
2.1.3 Configuration Example (GX/GP-GM).....	2-5
2.1.4 Configuration Example (GX/GP-UT).....	2-9
2.1.5 Configuration Example (GM-UPM)	2-13
2.2 Connection	2-17
2.2.1 Status LED Indication.....	2-17
2.2.2 Connecting an External Antenna.....	2-19

Chapter 3 Network Overview

3.1 Wireless Communication Option.....	3-1
3.1.1 Wireless Communication Option.....	3-1
3.1.2 Network Join Mode	3-1
3.1.3 When Wireless Devices Are Used as Low-Speed Moving Bodies.....	3-2
3.1.4 Multidrop Connection	3-3
3.1.5 Packet Filtering Setup.....	3-3
3.2 Functions.....	3-4
3.3 Network Numbers and Network Names.....	3-5
3.3.1 Channel Numbers	3-5
3.3.2 PAN ID (Group Number)	3-6
3.3.3 Network Names.....	3-6
3.4 Multi-hop Communication	3-7
3.4.1 Network Participation and Route Configuration	3-7
3.4.2 Network Scale Setup.....	3-8
3.4.3 Monitoring Unit Time of Radio Transmission.....	3-8

Chapter 4 Using the Maintenance Console

4.1 Overview of the Maintenance Console	4-1
4.1.1 Configuration Function of the Maintenance Console	4-1
4.2 Installation	4-2
4.2.1 System Requirements.....	4-2
4.2.2 Installing the Maintenance Console	4-2
4.3 Connection and Startup	4-3
4.3.1 Connection Configuration.....	4-3
4.3.2 Starting and Closing the Maintenance Console	4-4
4.3.3 Maintenance Console's Main Window	4-4
4.4 Configuring the Maintenance Console Environment.....	4-5
4.4.1 Environment Setup Window	4-5
4.5 Configuring the Coordinator Module	4-7
4.5.1 Setup Procedure	4-7

Contents

4.5.2	Coordinator configuration selection window.....	4-8
4.5.3	Coordinator Configuration Window	4-9
4.5.4	MAC Address List Window (sub window).....	4-19
4.5.5	Station Number List Window (sub window).....	4-22
4.5.6	Status Window	4-24
4.5.7	Setting the Network Scale (Network scale setup).....	4-25
4.6	Configuring Router Modules	4-27
4.6.1	Setup Procedure	4-27
4.6.2	Router configuration selection window.....	4-28
4.6.3	Router Configuration Window	4-29
4.6.4	Status Window	4-38
4.6.5	Setting the Network Scale (Network scale setup).....	4-40
4.7	Configuring the Coordinator Module (Low-speed moving body).....	4-42
4.7.1	Setup Procedure	4-42
4.7.2	MAC Address List Window (sub window).....	4-53
4.7.3	Station Number List Window (sub window).....	4-57
4.7.4	Status Window	4-59
4.7.5	Setting the Network Scale (Network scale setup).....	4-61
4.8	Configuring the Router Module (Low-speed moving body).....	4-63
4.8.1	Setup Procedure	4-63
4.8.2	Router configuration selection window.....	4-64
4.8.3	Router Configuration Window	4-65
4.8.4	Status Window	4-72
4.8.5	Setting the Network Scale (Network scale setup).....	4-74
4.9	Other Functions (Tool Menu).....	4-76
4.10	Measurement tool	4-86
4.10.1	Channel Noise Scan Tool.....	4-86
4.10.2	Communication Test Tool	4-91

Chapter 5 List of Settings

5.1	List of Settings.....	5-1
5.1.1	Overview of Configuration Files	5-1
5.1.2	Basic Configuration Items	5-2
5.1.3	Communication Setup Items	5-3
5.1.4	Protocol Setup Items	5-3
5.1.5	Packet Filtering Setup Items	5-3
5.1.6	Station Number Setup Items	5-4
5.1.7	Fixed Route Setup Items.....	5-4
5.1.8	Password Setup Items	5-4

Appendix

Appendix 1	Troubleshooting.....	App-1
Appendix 2	Frequently Asked Questions	App-7
Appendix 3	Different Versions and Connectivity	App-9
Appendix 4	Terminology.....	App-10
Appendix 5	System Operation Considerations	App-11

1.1 Overview

Wireless communication (900 MHz band) enables data communication between coordinators (GX20/GP20/GM10 (/CM2, /CM3)) and routers (GM10 (/CS2, /CS3), UT, UPM), wireless sensors (GX70SM). Because routers are equipped with a repeater function, they can be used to extend the communication distance.

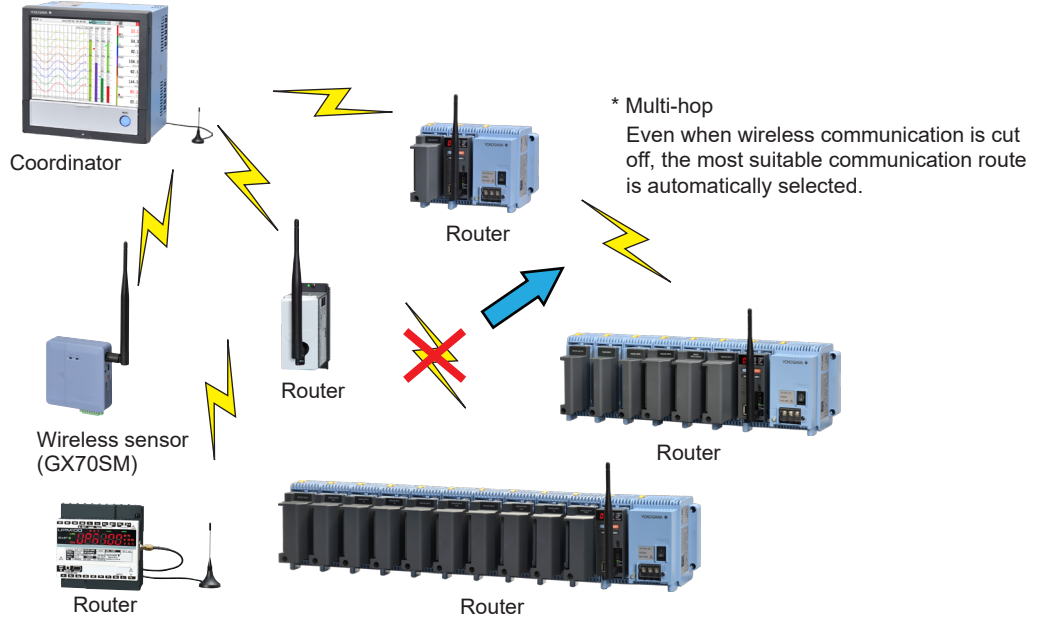

Features

- A single coordinator can accommodate up to 100 routers and wireless sensors.⁽¹⁾ The UT and UPM also function as serial gateway. The number of connected devices also includes the devices connected by the gateway. In the case of the wireless sensor (GX70SM), up to 96 routers can be connected by connecting four repeaters to a coordinator (wireless module version V 4.2.0 or later, GX/GP/GM release number 4.02 or later). Each coordinator and router can connect with up to 20 wireless sensors.
 - The output larger than that of conventional specified low power radio achieving a range of about 800 m⁽²⁾ or about 700 m⁽²⁾ with a clear line-of-sight.
 - With multi-hop connection, even when wireless communication is cut off due to temporary deterioration in radio conditions, the most suitable communication route is automatically selected to resume wireless communication. GM10 routers (/CS2 or /CS3 option), UT routers, and UPM routers can be used as repeaters to extend communication distance and improve radio quality.
 - Features of the 900 MHz band (compared to the 2.4 GHz band)
 - Because the radio frequency is low, radio signals attenuate less in the transmission route.
 - Because the radio frequency is low and the tendency to go straight is lower, the radio signals can more easily diffract around obstacles.
 - No license is required.
- 1 The number of units (include repeaters) that can connected may be limited by the communication data size or the transmission interval. When used for low-speed moving bodies, the maximum number of routers is limited to 50 including repeaters.
- 2 The range depends on the operating environment. FCC standards product is 800 m, KC mark conformity standards product is 700 m.

Advantages

- Wiring costs can be reduced when floor layout is changed.
- Addition of and changes to measurement points can easily be accommodated.
- Because the communication is wireless, routers, sensors, and the like can be installed in low-speed moving bodies to enable communication between them.

1.2 Specifications

1.2.1 Wireless Communication Function

Functions (For /CM2 and /CS2 options)

Item	Description		
	Coordinator (GX20/GP20/GM10 (/CM2))	Router (GM10 (/CS2))	Router (UT)
Standard	FCC Part 15 Subpart C compliant (§15.247)		
Carrier frequency band	902.1 to 927.9 MHz		
Wireless channel bandwidth	600 kHz		
Number of wireless channels	43 ch		
Maximum transmitter output	20 mW		
Modulation method	GFSK		
Antenna	External antenna (sold separately), SMA connector		
Maximum number of router receptions	100 (number of router receptions by a single coordinator, varies depending on the communication conditions)	—	—
Maximum packet size	2,048 bytes		—
Data rate	100 kbps max.		
Communication distance	Approx. 800 m with a clear line-of-sight (depends on the operating environment) ¹		
Communication format	Mesh, multi-hop (maximum number of hops: 16)		
LED display	Displays the wireless status using ST1 green/red and ST2 green/red (▶ for details, see section 2.2.1, "LED Display")		
Security function	AES 128 bit encryption		
Implemented protocol	Modbus (master) protocol	Modbus (slave) protocol	
Modbus master function (/CM2, /MC option) ²	Data can be written and read from Modbus slave devices. • Communication cycle: 500 ms, 1 s, 2 s, 5 s, 10 s, 1 min (If the receiver function is set to wireless input unit, see the user's manual of the wireless input unit.) Note: Only the above communication cycles will work properly. • Number of commands: 100 • Command types: Off, read, write • Connection destination address: 1 to 247 • Transmission command: INT16, UINT16, INT32_B, INT32_L, UINT32_B, UINT32_L, FLOAT_B, FLOAT_L, BIT	—	—
Modbus slave function (/CS2 option)	—	Data can be written and read from Modbus master devices (coordinators (/CM2 option)).	Data can be written and read from Modbus master devices.
Configuration and measurement communication	The following functions are available using the dedicated software. ³ • GX20/GP20/GM10 wireless communication settings • Information about routers connecting to the GX20/GP20/GM10 • GX20/GP20/GM10 wireless communication status monitoring		The following functions are available using the dedicated software. ³ UT52A/MDL, UT32A/MDL wireless communication configuration UT52A/MDL, UT32A/MDL wireless communication status monitoring
External interface for wireless configuration	USB 2.0 (mini-B type), reboot switch: for rebooting the system after changing wireless settings		

1 The communication distance varies depending on the installed antenna as follows:

Antenna type		Line-of-sight distance
Coordinator	Router	
Sleeve antenna	Sleeve antenna	Approx. 800 m
Roof top antenna	Roof top antenna	Approx. 800 m

2 The communication channel function (/MC option) is required. Read data is written to communication channels.

3 MH920 Console International, a console software application made by Oki Electric Industry Co., Ltd.

Functions (For /CM3 and /CS3 options)

Item	Description		
	Coordinator (GX20/GP20/GM10 (/CM3))	Router (GM10 (/CS3))	Router (UT / UPM)
Standard	IEEE 802.15.4g compliant KC mark conformity (Radio Waves Act)		
Carrier frequency band	902.6 to 923.4 MHz		
Wireless channel bandwidth	200 kHz		
Number of wireless channels	14 ch		
Maximum transmitter output	10 mW EIRP * (920.6 to 922.0 MHz) 25 mW EIRP * (922.0 to 923.4 MHz) * EIRP (Equivalent Isotropic Radiated Power): Radiated power including the antenna.		
Modulation method	GFSK		
Antenna	External antenna (sold separately), SMA connector		
Maximum number of router receptions	100 (number of router receptions by a single coordinator, varies depending on the communication conditions)	—	—
Maximum packet size	2,048 bytes		—
Data rate	100 kbps max.		
Communication distance	Approx. 800 m with a clear line-of-sight (depends on the operating environment) ¹		
Communication format	Mesh, multi-hop (maximum number of hops: 16)		
LED display	Displays the wireless status using ST1 green/red and ST2 green/red (▶ for details, see section 2.2.1, "LED Display")		
Security function	AES 128 bit encryption		
Implemented protocol	Modbus (master) protocol	Modbus (slave) protocol	
Modbus master function (/CM3, /MC option) ²	Data can be written and read from Modbus slave devices. • Communication cycle: 500 ms, 1 s, 2 s, 5 s, 10 s, 1 min (If the receiver function is set to wireless input unit, see the user's manual of the wireless input unit.) Note: Only the above communication cycles will work properly. • Number of commands: 100 • Command types: Off, read, write • Connection destination address: 1 to 247 • Transmission command: INT16, UINT16, INT32_B, INT32_L, UINT32_B, UINT32_L, FLOAT_B, FLOAT_L, BIT	—	—
Modbus slave function (/CS3 option)	—	Data can be written and read from Modbus master devices (coordinators (/CM3 option)).	Data can be written and read from Modbus master devices.
Configuration and measurement communication	The following functions are available using the dedicated software. ³ • GX20/GP20/GM10 wireless communication settings • Information about routers connecting to the GX20/GP20/GM10 • GX20/GP20/GM10 wireless communication status monitoring		The following functions are available using the dedicated software. ³ UT32A/MDL wireless communication configuration UT32A/MDL wireless communication status monitoring UPM100 wireless communication status monitoring
External interface for wireless configuration	USB 2.0 (mini-B type), reboot switch: for rebooting the system after changing wireless settings		

1 The communication distance varies depending on the installed antenna as follows:

Antenna type		Line-of-sight distance
Coordinator	Router	
Sleeve antenna	Sleeve antenna	Approx. 700 m
Roof top antenna	Roof top antenna	Approx. 700 m

2 The communication channel function (/MC option) is required. Read data is written to communication channels.

3 MH920 Console International, a console software application made by Oki Electric Industry Co., Ltd.

Number of connectable routers and number of connectable channels depending on Modbus communication cycle

Coordinator: GX/GP, Router: GM

Number of GM routers	Modbus communication cycle		
	500 ms	1 s	2 s
1	125 ch	370 ch	500 ch
2	80 ch	250 ch	500 ch
4	—	160 ch	500 ch
8	—	—	320 ch

* The number of channels for 1 word data (INT16, UINT16).
This varies depending on the processing load in the device and communication quality.

Connectable registers depending on the Modbus communication cycle

Coordinator: GX/GP, Router: UT

Number of UT routers	Modbus communication cycle			
	500 ms	1 s	2 s	5 s
1	27	100	100	100
2	—	27	100	100
4	—	—	27	100
8	—	—	—	58

* The number of readout registers when the GX20, GP20, or GM10 is the coordinator.
This varies depending on the processing load in the device and communication quality.



Connectable registers depending on the Modbus communication cycle

Coordinator: GX/GP, Router: UPM

Number of UPM routers	Modbus communication cycle		
	2 s	5 s	10 s
1	50	50	50
2	50	50	50
4	37	50	50
8	—	50	50

* The number of readout registers when the GX20, GP20, or GM10 is the coordinator.
This varies depending on the processing load in the device and communication quality.
* The number of registers for 2 word data (FLOAT, UINT32).

Dedicated external antenna (sold separately)*

Item	Type	
	Sleeve antenna	Roof top antenna **
Part No.	A1061ER	A1062ER
Installation environment	Indoors	Indoors and outdoors
Waterproof property	Not waterproof	Water resistant (IPX6)
Cable length	—	2.5 m
Antenna type	Dipole	Monopole
Maximum gain	3 dBi or less	2 dBi or less
Directivity	No	
Connector	SMA-P(reverse)	
Operating temperature range	-20 to 65°C	
Dimensions	196 mm (including the connector)	83 mm (including the base stand)
		

* Only dedicated antennas can be used.
** UPM100 can only use the roof top antenna.

2.1 Configuration

2.1.1 Preparation, Configuration, and Operation Check

GX/GP/GM

To configure (Modbus settings, wireless communication settings) and check the operation of the GX20, GP20, or GM10, follow the procedure below.

- 1** Modbus communication (serial communication) configuration
Configure the Modbus communication settings by referring to the GX/GP User's Manual (IM 04L51B01-01EN) or the GM User's Manual (IM 04L55B01-01EN) and section 2.1.2, "Default Settings," and section 2.1.3, "Configuration Examples" in this manual.
 - Communication (Serial) settings
 - ▶ GX/GP User's Manual: 1.18, "Configuring the Serial Communication Function (/C2 and /C3 options)"
 - GM User's Manual: 2.19, "Configuring the Serial Communication Function (/C3 option)"
 - Communication channel settings
 - ▶ GX/GP User's Manual: 1.16, "Configuring Communication Channels (/MC option)"
 - GM User's Manual: 2.17, "Configuring Communication Channels (/MC option)"
- 2** Maintenance console preparation
Download the maintenance console by following the link at the following URL, and install it.
<<http://www.smartdacplus.com/software/smart920/en/>>
 - * The maintenance console is an application made by Oki Electric Industry Co., Ltd.
- 3** Configuration file preparation
Using the maintenance console, create a configuration file consisting of basic settings, protocols, communication settings, and other wireless network settings according to your wireless network configuration.
You can also use the maintenance console to configure the GX20, GP20, or GM10 directly without creating a configuration file.
 - ▶ For details on the wireless communication configuration, see chapters 3, 4, and 5.
- 4** Wireless communication configuration (network configuration)
 - Connect the maintenance PC to the wireless configuration connector of the GX20, GP20, or GM10 with a mini USB cable. Then, write the configuration file into the wireless module.
 - After writing, press the reboot switch on the GX20, GP20, or GM10 to restart the system and apply the settings.
- 5** Network join confirmation
When the GX/GM joins a network, the green status ST1 LED blinks slowly, and the green ST2 turns on. ▶ For details on the LED indication, see section 2.2.1, "Status LED Indication."
 - * Turn the routers on after starting the coordinator. This will make network connection authentication quicker.

UT/UPM

To configure (Modbus settings, wireless communication settings) and check the operation of the UT/UPM, follow the procedure below.

- 1** Modbus communication (serial communication) configuration
Configure the Modbus communication settings by referring to the UT/UPM User's Manual and section 2.1.2, "Default Settings," and section 2.1.3, "Configuration Examples" in this manual.
The UT/UPM communication parameter settings are shown below. Do not change them from their default values. If you change them, communication will fail to work properly.
 - Protocol: Modbus (RTU)
 - Baud rate: 9600 bps for UT, 19200 bps for UPM
 - Parity: None
 - Stop bits: 1 bit
 - Data length: 8 bits

- 2** Maintenance console preparation
Download the maintenance console by following the link at the following URL, and install it.
<<http://www.smartdacplus.com/software/smart920/en/>>

* The maintenance console is an application made by Oki Electric Industry Co., Ltd.

- 3** Configuration file preparation
Using the maintenance console, create a configuration file consisting of basic settings, protocols, communication settings, and other wireless network settings according to your wireless network configuration.
Do not change the wireless serial settings from their default values. If you change them, communication will fail to work properly.
 - Bit rate: 115200 bps
 - Bit length: 8 bits
 - Stop bits: 1 bit
 - Parity: NoneYou can also use the maintenance console to configure the UT/UPM directly without creating a configuration file.
▶ For details on the wireless communication configuration, see chapters 3, 4, and 5.

- 4** Wireless communication configuration (network configuration)
Connect the maintenance PC to the UT/UPM's wireless communication configuration port with a mini USB cable. Then, write the configuration file into the wireless module. After writing, press the reboot switch on the UT/UPM or remove the mini USB cable to restart the system and apply the settings. (Hold down the reboot switch for several seconds until the status LED turns off.)

- 5** Network join confirmation
When the GX/GM joins a network,* the green status ST1 LED blinks slowly, and the green ST2 turns on.

* Turn the routers (UT/UPMs) on after starting the coordinator (GM10 /CM2, GM10/CM3, GX20/CM2, GX20/CM3, GP20/CM2 or GP20/CM3). This will make network connection authentication quicker.

GX70SM

For the configuration for connecting a GX70SM, see the wireless input unit user's manual (IM 04L57B01-01EN).

To configure a GX/GP/GM (release number 4.02 and later) that supports wireless input units, use the latest maintenance console (by Oki Electric Industry Co., Ltd.).

2.1.2 Default Settings

• Wireless communication parameters

	Parameter	Coordinator	Router
Basic configuration	Network join mode	Fast join mode	
	PAN ID (group number)	0001	
	Radio channel number	1ch	
	Short address	—	0001
	Low-speed moving mode	—	No
	Network name	MH920	
	Encryption key	00000000000000000000000000000001	
	Prefix	2001 : 0000 : 0000 : 0001	—
	MAC address authentication	No	—
	Antenna setup	Hardware (external antenna)	
	Radio utilization rate restriction	10.00%	
	Monitoring unit time of radio transmission	60 seconds	
	Transmitter power output	20 mW (for FCC) or 5 mW (for KC mark)	
	Retry times before route switching	Three times	
Communication setup	Bit rate	115200 bps	
	Bit length	8 bit	
	Stop bit	1 bit	
	Parity	None	
	Equipment Connection	—	Yes
Protocol setup	Station number analysis	Yes	—
	Data transmission interval when transmitting to all the child devices	Configuration not necessary	—
	Protocol type	Modbus (RTU)	—
	Modbus (RTU) Presence of broadcast address	No	—
	Other (ASCII)	Configuration not necessary	—
	Add sender identification	Default value: No	
	Packet filtering	Yes (notification type)	
Filter timeout on polling	Configuration not necessary		
Fixed route setup	Fixed route	—	No
	Destination short address	—	Configuration not necessary
	Temporary detour	—	Configuration not necessary
Station number setup	Specification method of Station numbers	List	—
	Station number list: Short address	0001	—
	Station number list: Station number	01	—

● **Wireless communication Modbus parameters (GX/GP/GM)**

Communication (Serial) settings

Parameter		Coordinator	Router
Basic configuration	Receiver	Function	Modbus master
		Address	10
	Data transfer*	Baud rate	115200
		Parity bit	None
		Stop bit	1 bit
Modbus master		—	—
Basic configuration	Master function	On/Off	On
	Communication	Interval	1 s
		Communication timeout	1 s
		Gap between messages	Off
	Recovery action	Retry	Once
	Wait time	5 s	
Command settings	Master command number		1
	Command settings	Type	Read
		Slave	1
		Data type	INT32 L
		Register	300001
		Channel type	Communication channel
		First-CH	0001
Last-CH	0001		
			Configuration not necessary

* If you change the data transfer settings, communication will fail to work. Do not change them.

● **Wireless communication Modbus parameters (UT)**

Communication (Serial) settings

Parameter	Router
Basic configuration	Modbus/RTU
Protocol*	Modbus/RTU
Address	1
Baud rate*	9600
Parity bit*	NONE
Stop bit*	1 bit

* If you change the data transfer settings, communication will fail to work. Do not change them. Specify the same settings for gateway connection devices.

● **Wireless communication Modbus parameters (UPM)**

Communication (Serial) settings

Parameter	Router
Basic configuration	Modbus/RTU
Protocol*	Modbus/RTU
Address	1
Baud rate*	19200
Parity bit*	NONE
Stop bit*	1 bit

* If you change the data transfer settings, communication will fail to work. Do not change them. Specify the same settings for gateway connection devices.

2.1.3 Configuration Example (GX/GP-GM)

This section describes a configuration example in which one-to-one wireless communication is performed between a GX20/GP20 (coordinator) and a GM10 (router) to read the measured values of GM10 channel 0001 into GX20/GP20 communication channel C001 and display them.

It is assumed that GM10 channel 0001 is set to 0.0 to 100.0°C span.

Factory default values are used for the wireless communication module settings.

Default values are used for settings other those described in this configuration example. In actual practice, you will need to change the settings according to your operating conditions.

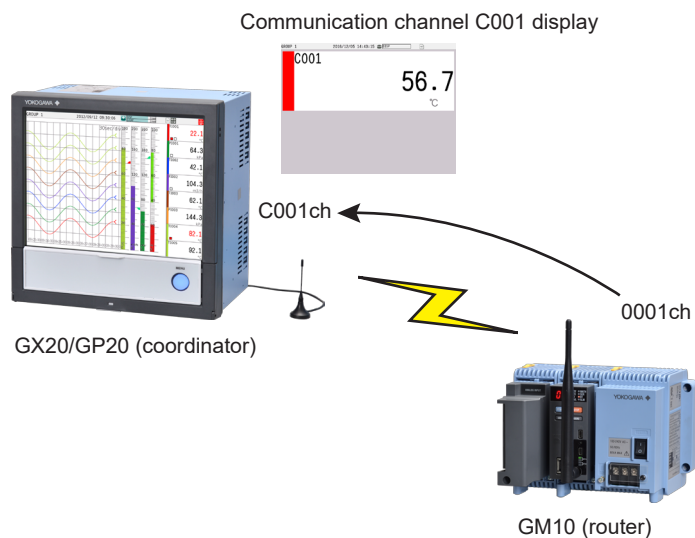

GX20/GP20 (coordinator) Configuration

Displaying the Setting Screen

- 1 Tap the **MENU** key, the **Browse** tab, and then **Setting**.

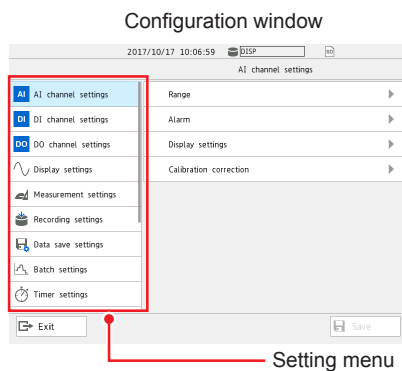

Operation complete

Communication (Serial) Settings

1 From the setting menu, select **Communication (Serial) settings**.

2 Select **Basic settings**. Set the following setup items. When you are finished, select **Save**.

Setup item		Value
Receiver	Function	Modbus master
	Address	10
Data transfer*	Baud rate	115200
	Parity bit	None
	Stop bit	1 bit

* Do not change them.

3 Select the Back icon (), or select **Communication (Serial) settings**.

4 Select **Modbus master** and then **Basic settings**. Set the following setup items. When you are finished, select **Save**.

Setup item		Value
Master function	On/Off	On
Communication	Interval*	1 s
	Communication timeout	1 s
	Gap between messages	Off
Recovery action	Retry	Once
	Wait time	5 s

* Refer to “[Reference] Simple Calculation Method of Data Acquisition Interval” in section 5.4.5, “Monitoring Unit Time of Radio Transmission,” of appendix 5.

5 Select the Back icon (), or select **Communication (Serial) settings**.

6 Select **Modbus master** and then **Command settings**. Set the following setup items. When you are finished, select **Save**.

Setup item		Value
Master command number		1
Command settings	Type	Read
	Slave	1
	Data type	INT32 L
	Register	300001
	Channel type	Communication channel
	First-CH	0001
Last-CH	0001	

Operation complete

Communication Channel Settings

- 1 From the setting menu, select Communication channel settings.
- 2 Set **On/Off**, **Span**. Set the following setup items. When you are finished, select **Save**. If a message "Please set as recording channel" appears, select the close icon (✕).

Setup item		Value
First-CH		C001
Last-CH		C001
On/Off, Span	On/Off	On
	Decimal place	1
	Span lower	0.0
	Span Upper	100.0
	Unit	°C

Operation complete

Display Settings

- 1 From the setting menu, select **Display settings**.
- 2 Select **Group settings** and then **Group settings [Channel set]**.
- 3 From the list, select **Communication channel** and then **C001**. Select **OK**.
- 4 Select **Save**.

Operation complete

Recording Settings

- 1 From the setting menu, select **Recording settings**.
- 2 Select **Recording channel settings** and then **Display data, Trend waveform**.
- 3 From the list, select **Communication channel** and then **C001**. Select **OK**.
- 4 Select **Save**.
- 5 Select **Exit** to close the setting screen.

Operation complete

GM10 (Router) Configuration

Communication (Serial) Settings

- 1 On the Web application, select the **Config**. tab, **Communication (Serial) settings**, and then **Serial basic settings**.
- 2 Set the following setup items. When you are finished, select **Update configuration**. When an Update configuration dialog box appears, click **OK**.

Setup item		Value
Receiver	Function	Modbus slave
	Address	1
Data transfer*	Baud rate	115200
	Parity bit	None
	Stop bit	1 bit

* Do not change them.

- 3 When a "Configuration were updated successfully" dialog box appears, click **OK**.

Operation complete

GX20/GP20 (Coordinator) Wireless Module Configuration

Connect a PC to the wireless communication module configuration USB port with a USB cable. Using the wireless communication module maintenance console (MH920 Console International), configure the wireless communication module. For the window configuration and other details of MH920 Console International, see chapter 4, “Using the Maintenance Console.”

- 1** Click **Coordinator configuration**.
- 2** Click **Module setup**.
- 3** Press **Connect**.
- 4** Click **Load from module**.
- 5** Click the **Station number setup** tab.
- 6** Click **Station number list**. Enter “0001” in the Short address box and “01” in the Station number box, and then click **Add to list**.
- 7** Click **Save to module**.
- 8** Press the reboot switch on the wireless communication module or turn the GX20 off and then back on to apply the settings.

Operation complete

2.1.4 Configuration Example (GX/GP-UT)

This section describes a configuration example in which one-to-one wireless communication is performed between a GX20/GP20 (coordinator) and a UT (router) to read the measured values (PV) of the UT into GX20/GP20 communication channel C001 and display them. It is assumed that the UT's PV is set to 0.0 to 100.0°C span.

Factory default values are used for the wireless communication module settings.

Default values are used for settings other those described in this configuration example. In actual practice, you will need to change the settings according to your operating conditions.

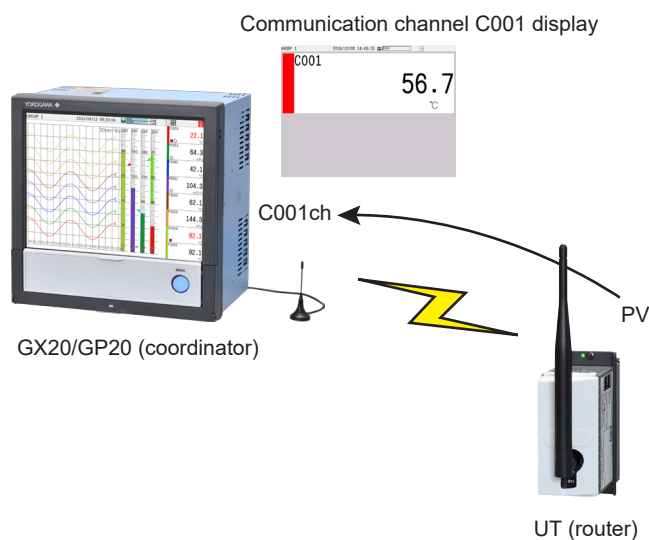

GX20/GP20 (coordinator) Configuration

Displaying the Setting Screen

- 1 Tap the **MENU** key, the **Browse** tab, and then **Setting**.

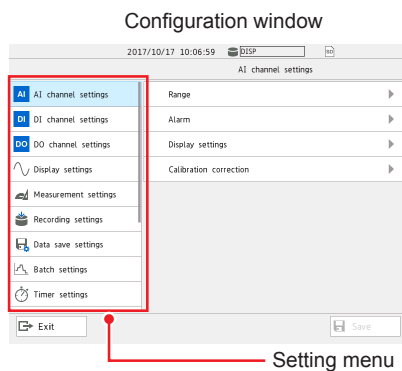

Operation complete

Communication (Serial) Settings

- 1 From the setting menu, select **Communication (Serial) settings**.
- 2 Select **Basic settings**. Set the following setup items. When you are finished, select **Save**.

Setup item		Value
Receiver	Function	Modbus master
	Address	10
Data transfer*	Baud rate	115200
	Parity bit	None
	Stop bit	1 bit

* Please do not change the settings.

- 3 Select the Back icon (), or select **Communication (Serial) settings**.
- 4 Select **Modbus master** and then **Basic settings**. Set the following setup items. When you are finished, select **Save**.

Setup item		Value
Master function	On/Off	On
Communication	Interval*	1 s
	Communication timeout	1 s
	Gap between messages	Off
Recovery action	Retry	Once
	Wait time	5 s

* Refer to “[Reference] Simple Calculation Method of Data Acquisition Interval” in section 5.4.5, “Monitoring Unit Time of Radio Transmission,” of appendix 5.

- 5 Select the Back icon (), or select **Communication (Serial) settings**.
- 6 Select **Modbus master** and then **Command settings**. Set the following setup items. When you are finished, select **Save**.

Setup item		Value
Master command number		1
Command settings	Type	Read
	Slave	1
	Data type	INT16
	Register	40003
	Channel type	Communication channel
	First-CH	0001
Last-CH	0001	

Operation complete

Communication Channel Settings

- 1 From the setting menu, select Communication channel settings.
- 2 Set **On/Off, Span**. Set the following setup items. When you are finished, select **Save**. If a message “Please set as recording channel” appears, select the close icon ().

Setup item		Value
First-CH		C001
Last-CH		C001
On/Off, Span	On/Off	On
	Decimal place	1
	Span lower	0.0
	Span Upper	100.0
	Unit	°C

Operation complete

Display Settings

- 1 From the setting menu, select **Display settings**.
- 2 Select **Group settings** and then **Group settings [Channel set]**.
- 3 From the list, select **Communication channel** and then **C001**. Select **OK**.
- 4 Select **Save**.

[Operation complete](#)

Recording Settings

- 1 From the setting menu, select **Recording settings**.
- 2 Select **Recording channel settings** and then **Display data, Trend waveform**.
- 3 From the list, select **Communication channel** and then **C001**. Select **OK**.
- 4 Select **Save**.
- 5 Select **Exit** to close the setting screen.

[Operation complete](#)

UT (Router) Configuration

Configure the UT communication settings with the LL50A Parameter Setting Software.

Communication (Serial) Settings

- 1 Set up the LL50A Parameter Setting Software.
See LL50A Parameter Setting Software with Ladder Program Building Function and Network Profile Creating Function Installation Manual (IM 05P05A01-01EN) and LL50A Parameter Setting Software with Ladder Program Building Function and Network Profile Creating Function User's Manual (IM 05P05A01-02EN).
- 2 Set the following parameters by referring to the LL50A User's Manual.

Setup item	Value
Protocol*	MBRTU: Modbus (RTU)
Baud rate*	9600
Parity bit*	None
Stop bit*	1 bit
Address	1

* Do not change them.

[Operation complete](#)

GX20/GP20 (Coordinator) Wireless Module Configuration

Connect a PC to the wireless communication module configuration USB port with a USB cable. Using the wireless communication module maintenance console (MH920 Console International), configure the wireless communication module.

For the window configuration and other details of MH920 Console International, see chapter 4, "Using the Maintenance Console."

- 1** Click **Coordinator configuration**.
- 2** Click **Module setup**.
- 3** Press **Connect**.
- 4** Click **Load from module**.
- 5** Click the **Station number setup** tab.
- 6** Click **Station number list**. Enter "0001" in the Short address box and "01" in the Station number box, and then click **Add to list**.
- 7** Click **Save to module**.
- 8** Press the reboot switch on the wireless communication module or turn the GX20 off and then back on to apply the settings.

Operation complete

2.1.5 Configuration Example (GM-UPM)

This section describes a configuration example in which one-to-one wireless communication is performed between a GM (coordinator, /CM3) and a UPM (router) to read the active energy of the UPM into GM communication channel C001ch and display them. Factory default values are used for the wireless communication module settings. Default values are used for settings other those described in this configuration example. In actual practice, you will need to change the settings according to your operating conditions.

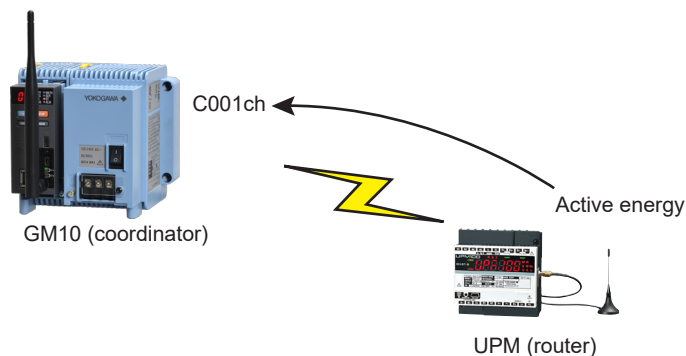

GM10 (coordinator) Configuration (Hardware configurator or Web application)

Displaying the Setting Screen

- 1 Web application: **Config.** tab > **Communication (Serial) settings** > **Serial basic settings**

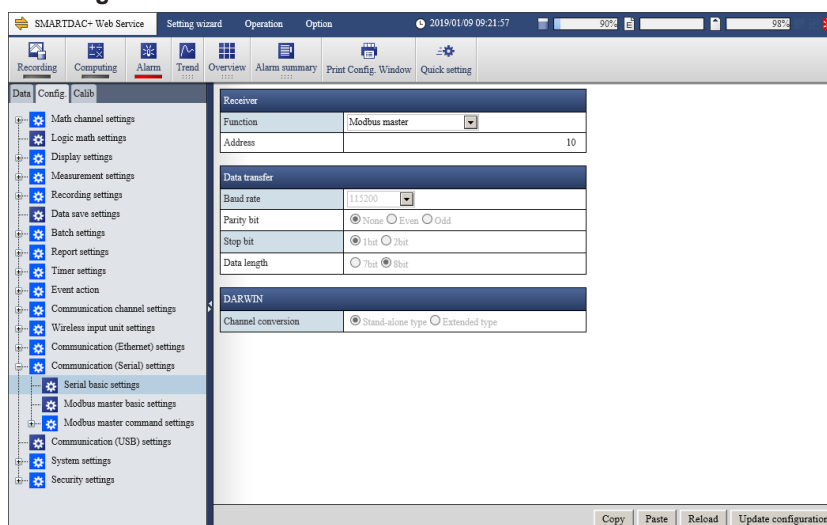

Operation complete

Communication (Serial) Settings

1 From the setting menu, select **Communication (Serial) settings**.

2 Set the following setup items. When you are finished, select **Update configuration**.

Setup item		Value
Receiver	Function	Modbus master
	Address	10
Data transfer*	Baud rate	115200
	Parity bit	None
	Stop bit	1 bit

* Please do not change the settings.

3 From the setting menu, select **Modbus master basic settings**.

4 Set the following setup items. When you are finished, select **Update configuration**.

Setup item		Value
Master function	On/Off	On
Communication	Interval*	1 s
	Communication timeout	1 s
	Gap between messages	Off
Recovery action	Retry	Once
	Wait time	5 s

* Refer to “[Reference] Simple Calculation Method of Data Acquisition Interval” in section 5.4.5, “Monitoring Unit Time of Radio Transmission,” of appendix 5.

5 From the setting menu, select **Modbus master command settings (1-20)**.

6 Set the following setup items. When you are finished, select **Update configuration**.

Setup item		Value
Master command number		1
Command settings	Type	Read
	Slave	1
	Data type	UINT32_B
	Register	40001
	Channel type	Communication channel
	First-CH	0001
	Last-CH	0001

Operation complete

Communication Channel Settings

1 From the setting menu, select **Communication channel settings > C001-C020 > On/Off, Span**.

2 Set the following setup items. When you are finished, select **Update configuration**.

Setup item		Value
First-CH		C001
Last-CH		C001
On/Off, Span	On/Off	On
	Decimal place	0
	Span lower	0
	Span Upper	99999999
	Unit	WH

Operation complete

Recording Settings

- 1 From the setting menu, select **Recording settings**.
- 2 Select **Recording channel settings**.
- 3 From the list, select **Communication channel** and then **C001**.
- 4 Select **Update configuration**.
- 5 Select **Exit** to close the setting screen.

Operation complete

UPM (Router) Configuration

UPM with display function is operation key, UPM without display function is set by communication.

Communication (Serial) Settings

Set the following parameters by referring to the UPM User's Manual.

Setup item (Parameter symbol)	Value
Protocol* (COMM)	M RTU: Modbus (RTU)
Baud rate* (B-RT)	19200
Parity bit* (PRI)	None
Stop bit* (STP)	1 bit
Address (ST-NO)	1

* Do not change them.

Operation complete

GM10 (Coordinator, /CM3) Wireless Module Configuration

Connect a PC to the wireless communication module configuration USB port with a USB cable. Using the wireless communication module maintenance console (MH920 Console International), configure the wireless communication module.

For the window configuration and other details of MH920 Console International, see chapter 4, "Using the Maintenance Console."

- 1** Click **Coordinator configuration**.
- 2** Click **Module setup**.
- 3** Press **Connect**.
- 4** Click **Load from module**.
- 5** Click the **Station number setup** tab.
- 6** Click **Station number list**. Enter "0001" in the Short address box and "01" in the Station number box, and then click **Add to list**.
- 7** Click **Save to module**.
- 8** Press the reboot switch on the wireless communication module or turn the GX20 off and then back on to apply the settings.

Operation complete

2.2 Connection

2.2.1 Status LED Indication

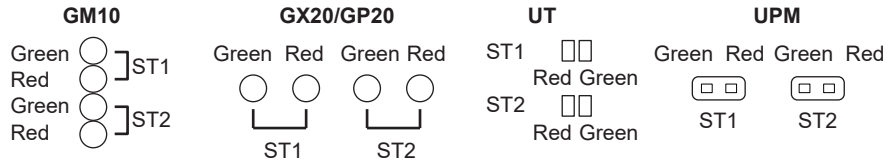

Name	LED control signal		Status	Notes
	Green	Red		
ST1_ Green/red ¹	Blinking in sync at 1 second intervals	On	Updating firmware	Transferring files
	On	On	Opening files	
	Blinking at 0.2 second intervals	Off	Normal	Not joined the network
	Blinking at 1 second intervals	Off	Normal	After IP is established upon joining network
	Off	Blinking at 1 second intervals	Failure ²	
	Alternate blinking of green and simultaneous green and red at 1 second intervals		Radio transmission time exceeded	
ST2_ Green/red ¹	On	Off	Network join authentication Success/Normal	
	Off	Blinking at 1 second intervals	Network join authentication Fail ²	
	Blinking in sync at 1 second intervals	Off	No detour route ²	
	Alternate blinking at 1 second intervals	Off	Wireless stopped	
	Blinking	Off	Transmitting/receiving serial communication	
	Off	Off	Not joined the network or disconnected from network	

- 1 This table does not apply when determining the radio condition using the maintenance console software.
- 2 System error status. Using the maintenance console software, correct the installation environment to an appropriate condition.

LED position (GM/GX/GP)

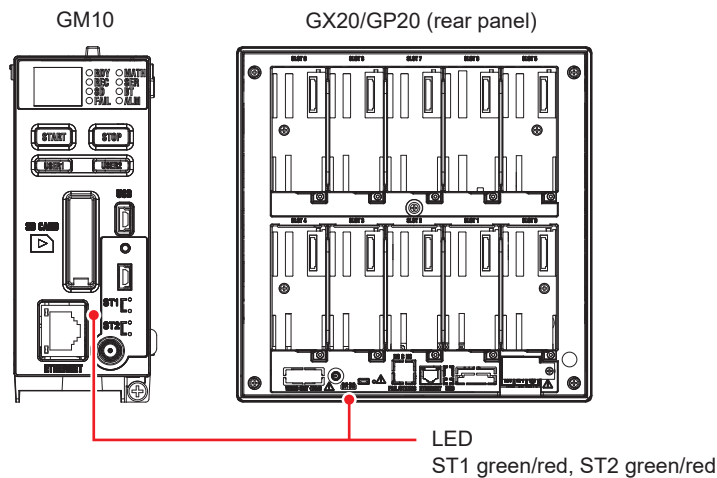

LED position (UT)

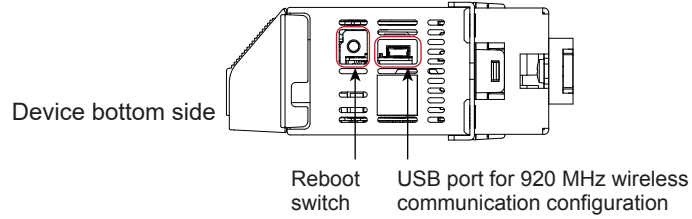
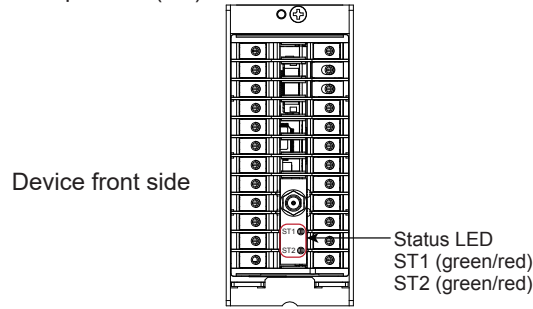

LED position (UPM)

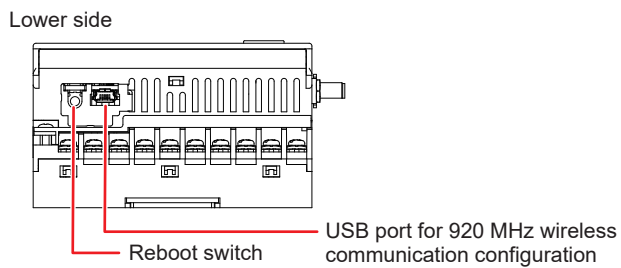
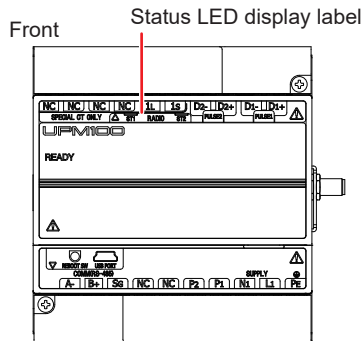
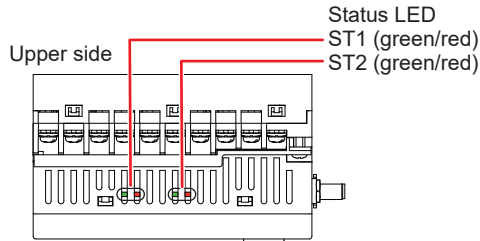

2.2.2 Connecting an External Antenna

Sleeve Antenna (GX/GP/GM)

Sleeve antennas (not waterproof) are used indoors or inside a case. Sleeve antennas do not have directivity. They can also be bent and rotated to change the antenna direction. As such, they can be used anywhere indoors.

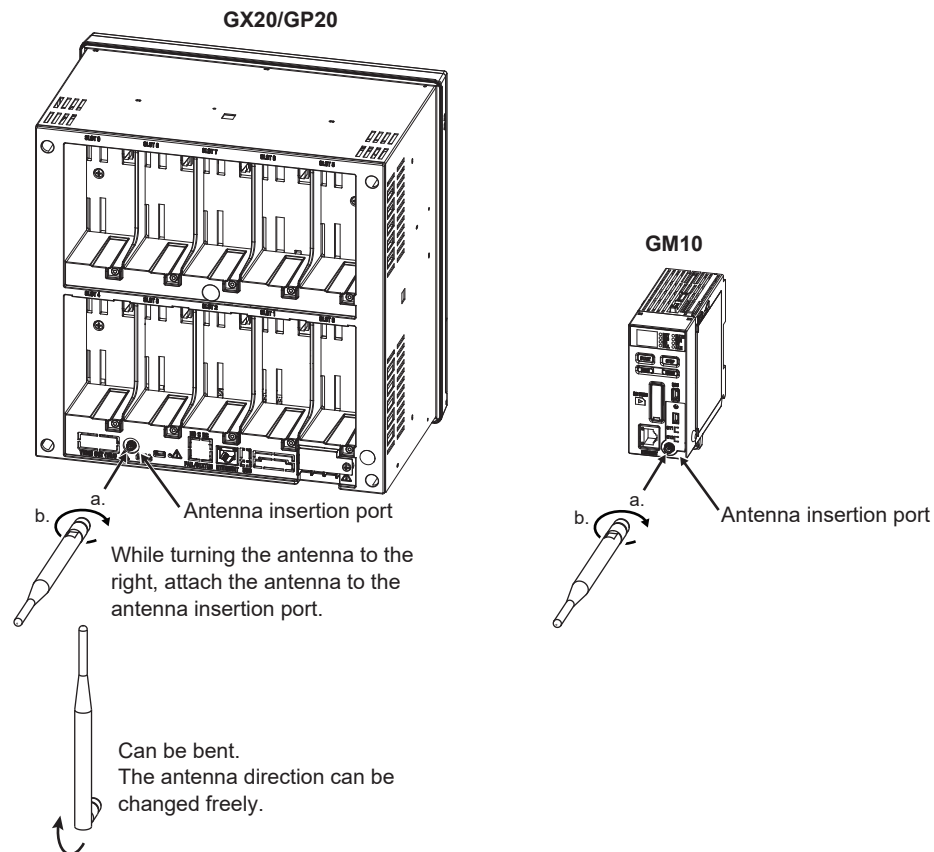

Roof Top Antenna (GX/GP/GM)

Roof top antennas (waterproof) are used when you want to install only the antenna in a remote location such as outdoors.

There is a magnet on the bottom side, so they can be attached to metal boxes and the like.

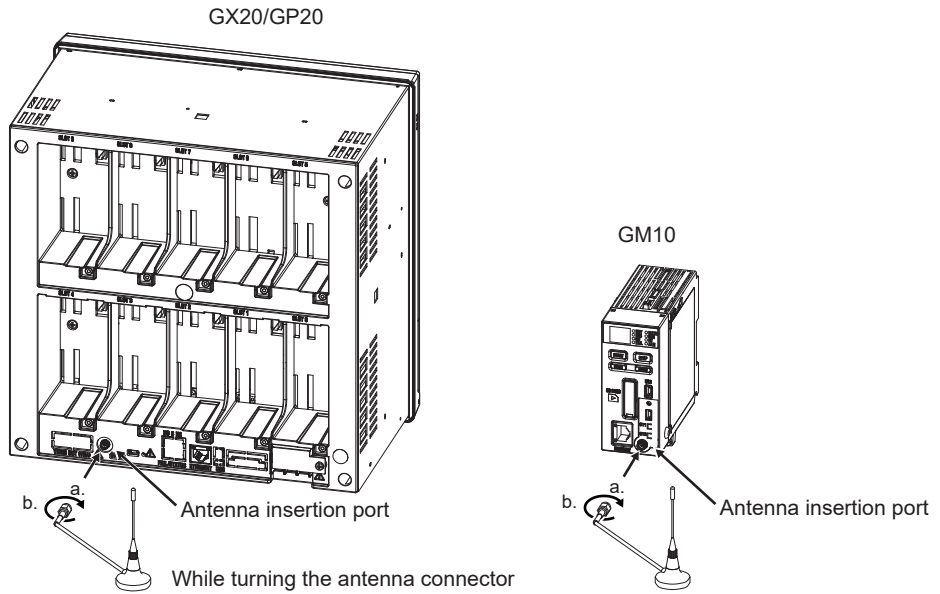

While turning the antenna connector to the right, attach the antenna to the antenna insertion port.

* Use a torque wrench (wrench width 5/16 inches, tightening torque 0.56 to 0.90 N•m).

NOTE

- To bring out the full performance of the antenna, install it on top of a metal rectangle board that is at least 10 × 20 cm long.
- Install antennas as far as possible from metal objects and other obstacles. The communication quality may deteriorate if they are close.
- When installing the antenna, make sure no foreign matter gets caught between the bottom side of the antenna and the installation plane.
- Do not bend the antenna cable more than the allowable bend radius of 3 cm.
- When installing the antenna in an area subject to lightning, be sure to install the antenna at a position safe from lightning and at a position lower than the height of other cases.

Sleeve Antenna (UT)

Sleeve antennas (not waterproof) are used indoors or inside a case. Sleeve antennas do not have directivity. They can also be bent and rotated to change the antenna direction. As such, they can be used anywhere indoors.

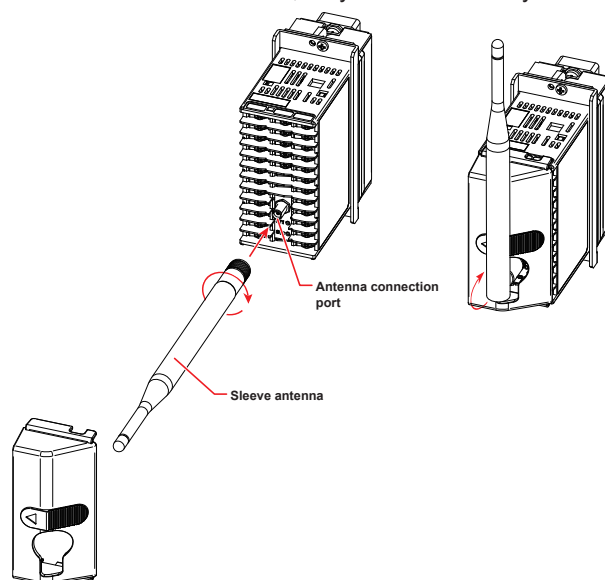

Roof Top Antenna (UT)

Roof top antennas (waterproof) are used when you want to install only the antenna in a remote location such as outdoors. There is a magnet on the bottom side, so they can be attached to metal boxes and the like.

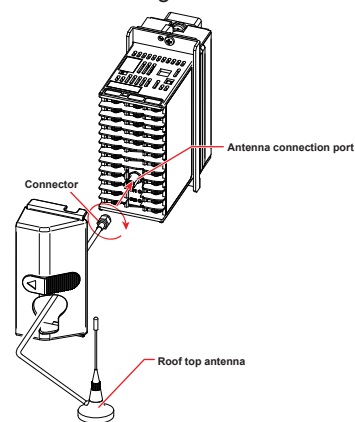

NOTE

- To bring out the full performance of the antenna, install it on top of a metal rectangle board that is at least 10 × 20 cm long.
- Install antennas as far as possible from metal objects and other obstacles. The communication quality may deteriorate if they are close.
- When installing the antenna, make sure no foreign matter gets caught between the bottom side of the antenna and the installation plane.
- Do not bend the antenna cable more than the allowable bend radius of 3 cm.
- When installing the antenna in an area subject to lightning, be sure to install the antenna at a position safe from lightning and at a position lower than the height of other cases.

While turning the antenna connector to the right, attach the antenna to the antenna connection port.

* Use a torque wrench (wrench width 5/16 inches, tightening torque 0.56 to 0.90 N•m).

Roof Top Antenna (UPM)

Roof top antennas (waterproof) are used when you want to install only the antenna in a remote location such as outdoors.

There is a magnet on the bottom side, so they can be attached to metal boxes and the like.

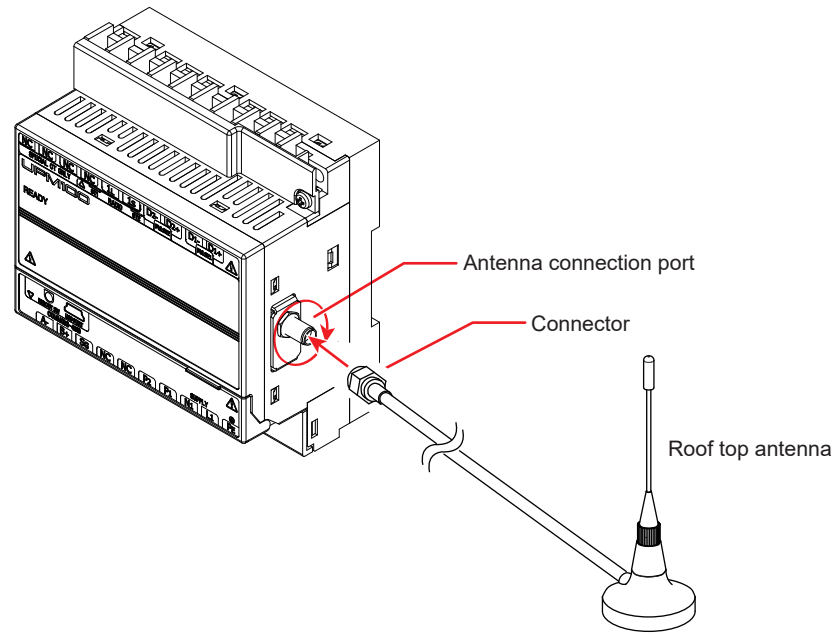

NOTE

- To bring out the full performance of the antenna, install it on top of a metal rectangle board that is at least 10 × 20 cm long.
- Install antennas as far as possible from metal objects and other obstacles. The communication quality may deteriorate if they are close.
- When installing the antenna, make sure no foreign matter gets caught between the bottom side of the antenna and the installation plane.
- Do not bend the antenna cable more than the allowable bend radius of 3 cm.
- When installing the antenna in an area subject to lightning, be sure to install the antenna at a position safe from lightning and at a position lower than the height of other cases.

While turning the antenna connector to the right, attach the antenna to the antenna connection port.

* Use a torque wrench (wrench width 5/16 inches, tightening torque 0.56 to 0.90 N•m).

3.1 Wireless Communication Option

3.1.1 Wireless Communication Option

The wireless communication option allows wired serial communication to be transformed into a wireless network configuration.

Coordinators are equipped with wireless communication coordinator modules and routers with wireless communication router modules.

3.1.2 Network Join Mode

You can select the network join mode for wireless communication modules.

There are two types of network join modes: Fast join mode and V3-compatible mode.

The above two modes can be specified for wireless modules with firmware version v4.x or more.

Fast join mode reduces the time for joining a network.

The minimum network join time of a wireless communication module is about 5 seconds.

V3-compatible mode provides connection compatibility with wireless devices with firmware version v3.x and earlier. The minimum network join time of a wireless communication module is about 30 seconds.

Set the same network join mode for all wireless devices in the same network.

When using a wireless device as a low-speed moving body, be sure to set the network join mode to V3-compatible mode.

Note

- Set the same network join mode for all wireless devices in the same network. Otherwise, devices will not be able to join the network.
- In the following situations, be sure to set the network join mode to V3-compatible mode.
 1. When there are wireless devices with firmware version v3.x in the wireless network
 2. When there are wireless devices used as low-speed moving bodies in the wireless network

If Network join mode is set to Fast join mode, Low-speed moving mode cannot be set to Yes.

3.1.3 When Wireless Devices Are Used as Low-Speed Moving Bodies

When a coordinator and routers are configured for low-speed movement, data acquisition through serial communication becomes possible between data acquisition devices and various sensors and the like moving at low speeds (4 km/hr or less). Such networks consist of coordinator modules, repeaters, and router modules installed in low-speed moving devices all configured for low-speed movement. Routers installed in low-speed moving devices do not have repeater capabilities. Up to a total of 50 repeaters and routers can be accommodated. It is assumed that coordinators and routers are used in an environment with uninterrupted power supplies and that radio signals from the coordinator and routers reach the entire area in which low-speed moving devices move. If a coordinator is turned off and then back on after the network has been configured, it may take as long as an hour for the network to recover.

When a router moves, it communicates by repeatedly switching the connection to the coordinator or repeater with the best radio condition. By using this system, you can manage the positions of low-speed moving devices, collect sensor information, and transmit information.

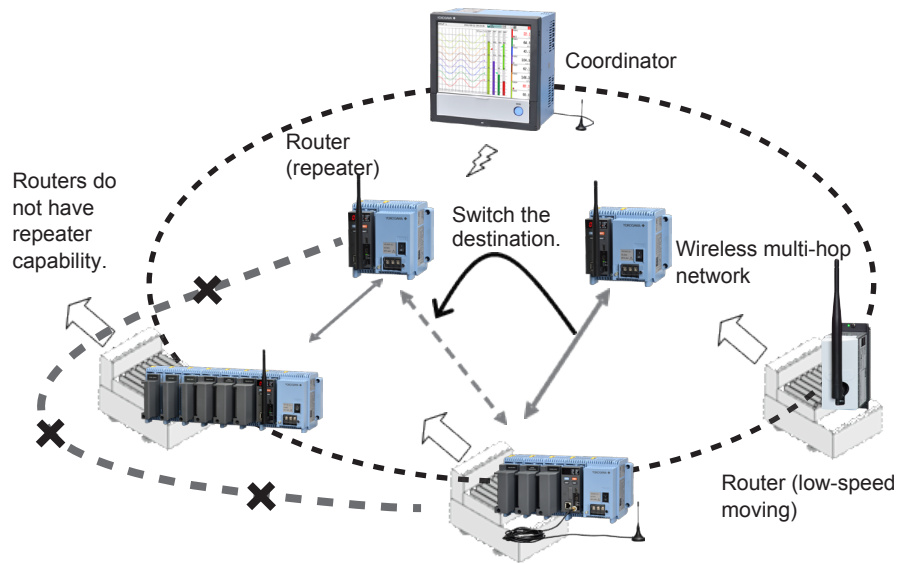

Note

- When using low-speed moving bodies, be sure to set the network join mode to V3-compatible mode. For details, see sections 4.7 and 4.8.
- If there is a risk that the power to the coordinator may be interrupted, take power failure measures such as using a UPS system. (If the power to the coordinator is interrupted unexpectedly, resume communication by restarting all repeaters and routers. This may take several minutes.)

3.1.4 Multidrop Connection

By using the serial gateway function, a UT/UPM with a wireless function can connect to a RS485 device.

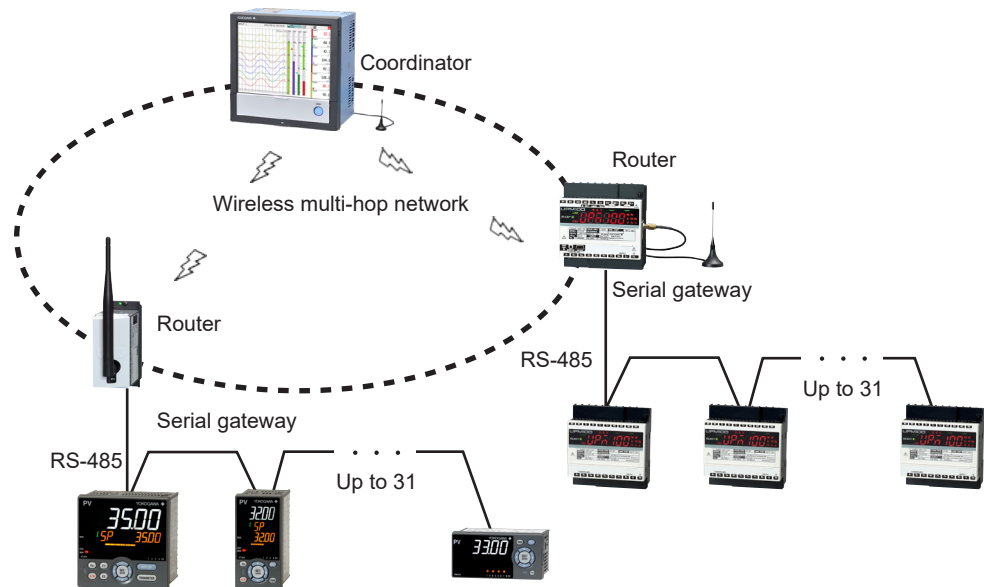

3.1.5 Packet Filtering Setup

When the wireless condition is poor during packet transmission, routers temporarily communicate through other wireless devices instead of through the normal communication route in order to improve reachability. In such situations, a duplicate packet may reach the coordinator. Packet filtering is a function that enables a coordinator to discard such packets.

■ Note

For setting the packet filtering, see “Configuring the Interface (Protocol setup tab)” in “Coordinator Configuration Window” of section 4.5, “Configuring the Coordinator Module” and “Configuring Packet filtering (Protocol setup tab)” in “Router Configuration Window” of section 4.6, “Configuring the Router Module.”

3.2 Functions

The following table shows the main functions available in the product.

Function	Description	Coordinator module	Router module
Fast network joining	A function that reduces the network join time of router modules.	Yes	Yes
Low-speed moving mode	A function incorporated into low-speed moving bodies to enable sensor information collection and data communication.	Yes	Yes
Antenna/diversity selection	A function for selecting the external antenna (option) or the diversity of the combination of antennas.	Yes	Yes
Station number analysis	A coordinator module function for associating short addresses assigned to router modules with station numbers assigned to sensor devices and the like and enabling data communication with specific routers.	Yes	No
No station number analysis	A coordinator module function for sending data to all routers without analyzing station numbers. It allows data communication using original protocols that cannot be supported by the station number analysis function.	Yes	No
Packet filtering	A function for discarding duplicate data and delay data occurring over the wireless segment.	Yes	Yes
Fixed route	A function for connecting to a specific wireless device. If the quality of communication with the specified destination deteriorates, communication can be performed by temporarily bypassing the problematic communication route.	No	Yes
Measurement tool	A function for performing channel noise scan, which measures the RSSI value (reception signal strength) of a specified channel at certain time intervals and communication tests that measure the RSSI value and packet error rate (PER) between two devices. During a communication test using the measurement tool, devices operate only as transmitters or receivers, not as repeaters.	Yes	Yes

Yes: Configuration necessary, No: Configuration not necessary

3.3 Network Numbers and Network Names

3.3.1 Channel Numbers

A coordinator must be assigned a channel number. Routers perform channel scanning among preassigned channel numbers on peripheral wireless devices and automatically select the same channel number as their priority wireless communication modules, which are their connection destinations. The following table shows the channel number assignments.

For /CM2 and /CS2 options

Radio channel number	Center frequency (MHz)	Transmission output *
1	902.4	0.16 mW 1 mW 20 mW
2	903.0	
3	903.6	
4	904.2	
5	904.8	
6	905.4	
7	906.0	
8	906.6	
9	907.2	
10	907.8	
11	908.4	
12	909.0	
13	909.6	
14	910.2	
15	910.8	
16	911.4	
17	912.0	
18	912.6	
19	913.2	
20	913.8	
21	914.4	
22	915.0	
23	915.6	
24	916.2	
25	916.8	
26	917.4	
27	918.0	
28	918.6	
29	919.2	
30	919.8	
31	920.4	
32	921.0	
33	921.6	
34	922.2	
35	922.8	
36	923.4	
37	924.0	
38	924.6	
39	925.2	
40	925.8	
41	926.4	
42	927.0	
43	927.6	

For /CM3 and /CS3 options

Radio channel number	Center frequency (MHz)	Transmission output *
1	920.7	0.16 mW 1 mW 5 mW
2	920.9	
3	921.1	
4	921.3	
5	921.5	
6	921.7	
7	921.9	
8	922.1	0.16 mW 1 mW 5 mW 12.5 mW
9	922.3	
10	922.5	
11	922.7	
12	922.9	
13	923.1	
14	923.3	

* Does not include antenna gain.

By using the channel noise scan function that is available as standard in wireless communication modules, you can check the radio usage condition of each channel. Check the radio usage condition at the planned installation location, and select channels with low noise. For details on the channel noise scan function, see section 4.10, "Measurement Tool."

3.3.2 PAN ID (Group Number)

Devices equipped with wireless communication modules configure wireless personal area networks (PANs) under a coordinator. A PAN-ID is an identifier given to a network (layer 3) under the coordinator. The coordinator must specify the PAN-ID in addition to the channel number. When several coordinators are used, be sure to assign different PAN-IDs to coordinators that are within each other's radio range. Coordinators automatically obtain their own PAN-IDs if specific PAN-IDs are not specified. During the network search that takes place when establishing network connection, routers choose the coordinator with the highest radio strength among the available PAN-IDs (coordinators) and assign themselves the same PAN-ID as the said coordinator. If a specific PAN-ID is assigned, connection to that PAN-ID is prioritized, regardless of the radio strength.

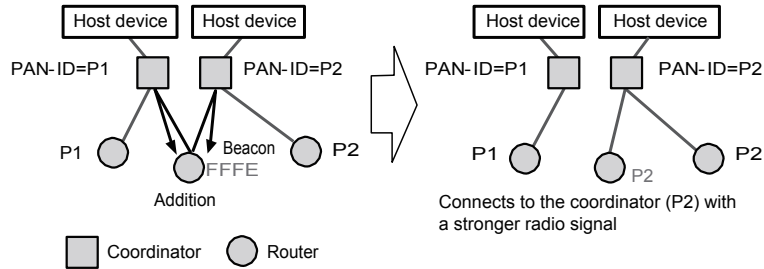

3.3.3 Network Names

A wireless PAN requires a network name. The relationship between a network name and PAN-IDs can either be 1:1 or 1:N. In other words, several PAN-IDs can be defined as a single network group. A router reads the network names in the beacon and identifies the network that it can connect to. For example, even if the radio strength is optimal, a router is not connected to a network with a different network name. The assignment of network names allows separation of networks according to the services used. It provides exclusive control, preventing connection authentication with irrelevant networks and making network operation efficient.

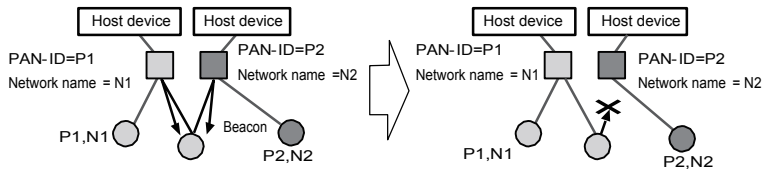

3.4 Multi-hop Communication

3.4.1 Network Participation and Route Configuration

A wireless multi-hop network can be configured by using a single coordinator and several routers.

Routers, after they start, search the network until a connection destination is found. Then, they join the wireless multi-hop network upon receiving approval from the coordinator and communicate using their assigned IPv6 addresses. IPv6 addresses are automatically assigned using the fixed prefix information set in the coordinator and the short addresses assigned to each coordinator and router.

- The shortest time it takes for a router module to join a network after turning the router module on with the coordinator module turned on in advance is about 5 seconds in fast join mode.

■ Upward route generation

- A router collects number-of-hops and communication-quality (packet error rate) information from adjacent coordinator and routers and determines the prioritized connection destination coordinator from a list of coordinate candidates selected by the adjacent devices.
- The upward route of routers is generated based on this information.

■ Downward route generation

- A router sends route information to the coordinator, and the coordinator registers the information in its route information table.
- The coordinator automatically generates a downward route (source routing) using this table and uses the route to communicate with the applicable router.

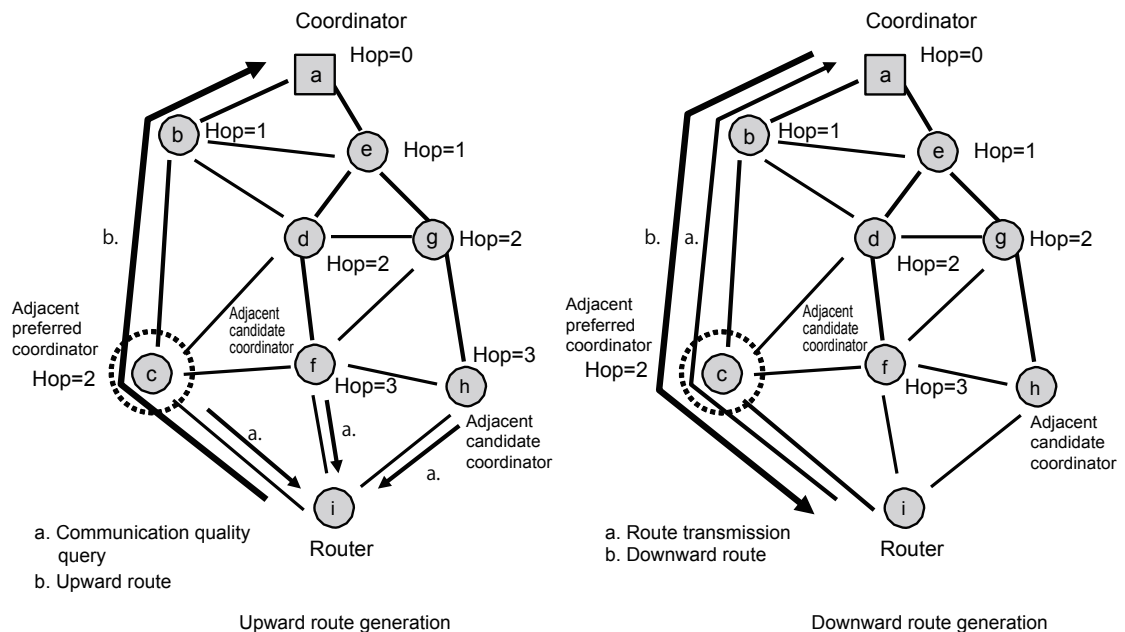

3.4.2 Network Scale Setup

This function enables parameter setup for each of the three available network sizes (1 to 30 units, 31 to 60 units, and 61 to 100 units) so that you can use the optimal parameter setup. The transmission frequency of control packets is adjusted according to the network size in order to perform stable network communication. Note that if a parameter that does not match the actual network configuration size is selected, congestion may occur in the network, and in the worst case, routers may be disconnected from the network.

3.4.3 Monitoring Unit Time of Radio Transmission

If used outside Japan, there is no limit to the transmission time. To turn off the limit function, set it as below.

Radio utilization rate restriction: 0.00%

The wireless multi-hop network function complies with ARIB STD-T108, a standard defined by Association of Radio Industries and Businesses (ARIB).

Wireless communication that use the 920 MHz frequency band must observe the transmission time limit (10% duty limit: radio transmission time must be no longer than 360 seconds for every hour) defined by ARIB STD-T108.

As such, wireless communication modules have a “monitoring unit time of radio transmission” function for measuring the radio usage rate. However, because the transmission time within a given 1-hour time frame must be kept no longer than 360 seconds, the transmittable time varies depending on each “monitoring unit time of radio transmission.”

The examples shown in the following figure are for when the monitoring unit time is set to 60 minutes and 30 minutes, respectively. If the monitoring unit time is set to 60 seconds, to keep the radio transmission time within 360 seconds in a given hour, the possible radio transmission time is 3 minutes because radio signals can be transmitted in the first and last 3 minutes of two consecutive monitoring unit times. Likewise, if the monitoring unit time is set to 30 minutes, the possible radio transmission time in 60 minutes is 4 minutes. Note that in reality, communication is possible for a time period shorter than 360 seconds. The default monitoring unit time in the maintenance console is 10 minutes (600 seconds), but the default value in the hardware is 60 seconds.

If the monitoring unit time is reduced, the ratio of the possible transmission time relative to that time period increases, but if numerous packets or large packets are transmitted in a short time period, the transmission time limit may be exceeded. On the other hand, if the monitoring unit time is increased, the ratio of the possible transmission time relative to that time period decreases, but the size of packets that can be transmitted within the monitoring unit time increases.

If a repeater wireless module violates the 10% duty limit, routers connected under the repeater will also no longer be able to communicate. However, if such routers have detour routes through a different repeater when communication failure is detected, communication continues through the detour route. Wireless communication modules that exceed the 10% duty transmission time limit will not be able to transmit radio signals for a given time period.

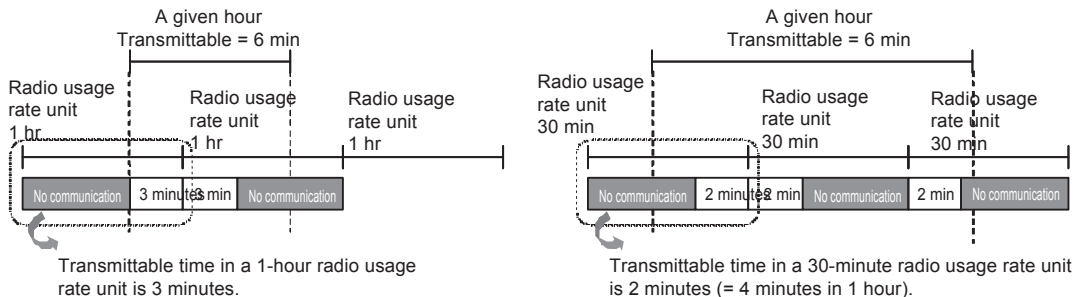

4.1 Overview of the Maintenance Console

The maintenance console is a tool that can be used to configure the environment and the wireless communication module. By using the maintenance console, you can configure the environment of the PC in which the console is installed (the maintenance console PC) and the wireless communication module. In addition to retrieving individual pieces of information already set in the wireless communication module, you can also load a configuration file containing various settings to configure the module at once.

Note

Do not remove the USB cable or cut off the power supply when the maintenance console is connected to a wireless communication module. If you perform these acts while data is being written to the wireless module (during firmware updating or configuration), the configuration information may become corrupted.

The maintenance console can configure and retrieve terminal information from wireless communication modules with a corresponding firmware version or earlier versions. If the version is earlier than the corresponding version, a portion of the settings cannot be set or retrieved from wireless modules. If this happens, an error message will appear.

4.1.1 Configuration Function of the Maintenance Console

Configuration Function		Description
Environment setup		Configure the environment of the maintenance console.
Coordinator configuration (master device)	Configuration	Configure the wireless communication coordinator module.
	Basic configuration	Configure the basic settings of a wireless communication coordinator module.
	Communication setup	Configure the serial communication settings.
	Protocol setup	Configure protocols.
	Station number setup	Set the specification method of station numbers.
	MAC address list	Set authentication information for accessing the wireless communication coordinator module.
	Allow radio device list	Register MAC addresses and encryption key information for routers accessing the wireless communication coordinator module.
	Refuse radio device list	In the wireless communication coordinator module, set MAC addresses of routers that you want to prevent from joining the wireless network.
	Station number list	Register combinations of short addresses and station numbers of devices connected to the routers.
	Detailed view	Displays the current status of the wireless communication coordinator module.
	Network scale setup	Set the network scale.
	Display topology	Displays the topology (network connection configuration).
	Get Log	Retrieves the log.
	Firmware update	Updates the firmware.
	Cancel radio transmission time display	Clears the radio transmission time display.
Restore factory preset	Restores the settings to their factory defaults.	
Router configuration (router)	Configuration	Configure a wireless communication coordinator module.
	Basic configuration	Configure the basic settings of a wireless communication router module.
	Communication setup	Configure the serial communication settings.
	Packet filtering setup	Set packet filtering.
	Fixed route setup	Configure fixed routes.
	Detailed view	Displays the current status of the wireless communication router module.
	Network scale setup	Set the network scale.
	Get Log	Retrieves the log.
	Firmware update	Updates the firmware.
	Cancel radio transmission time display	Clears the radio transmission time display.
Restore factory preset	Restores the settings to their factory defaults.	
Measurement tool	Starts various measurement tools	

4.2 Installation

4.2.1 System Requirements

The system requirements for the maintenance console are shown below. Check the requirements before installing the console in the PC.

■ Hardware requirements

Item	Requirement
CPU	Core Duo 1 GHz or equivalent or better
Memory	1 GB or more
Hard disk (required free space)	100 MB
Interface	USB*1

*1: The USB version is 1.1 or 2.0.

■ Software requirements

Item	Requirement
OS	Windows 7 Professional SP1 (32bit, 64bit) Windows 8.1 (32 bit, 64 bit) Windows 10 (32 bit, 64 bit)
Runtime	Microsoft .NET Framework version 4.0

4.2.2 Installing the Maintenance Console

Download the maintenance console. Follow the instructions in the maintenance console installation manual in the downloaded file to install the console and the USB driver for wireless communication modules. If an older version is already installed, uninstall it first, and then install the latest MH920 Console International.

Download the maintenance console by following the link at the following URL.

<<http://www.smartdacplus.com/software/smart920/en/>>

When the installation is completed, a shortcut icon of MH920 Console International will be created on the desktop of the maintenance console PC. You can use this icon to start the maintenance console.

By default, the maintenance console is installed in the following folder:

C:\Program Files\OKI\MH920 Console International\ (for 32 bit OSs)

C:\Program Files (x86)\OKI\MH920 Console International\ (for 64 bit OSs)

Note

Both the maintenance console and USB driver must be installed. If the USB driver is not installed, a message "USB driver not found" appears.

If this message appears, open the USB_Driver folder under the maintenance console installation folder (C:\Program Files\OKI\MH920 Console International by default).

Use the inf file in this folder.

* The maintenance console is an application made by Oki Electric Industry Co., Ltd.

4.3 Connection and Startup

4.3.1 Connection Configuration

Connect the maintenance console PC and the device (GX20/GP20/GM10/UT/UPM) equipped with the wireless communication module using a USB cable.

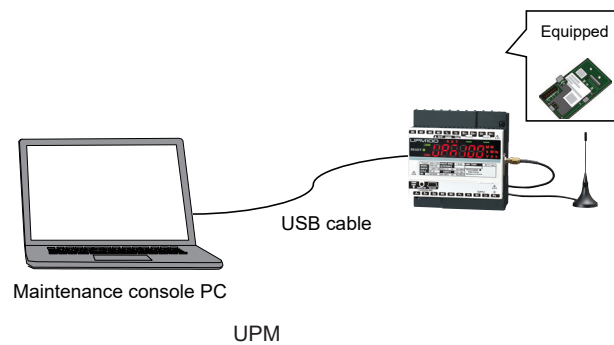
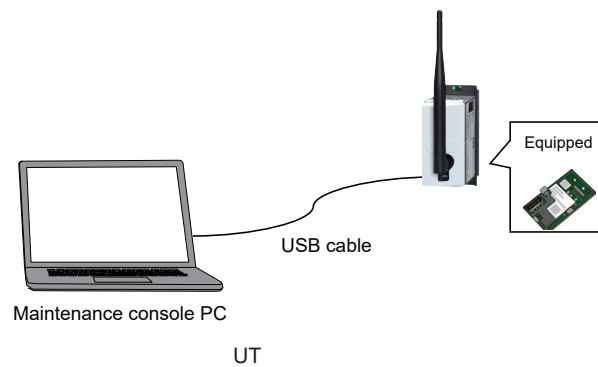
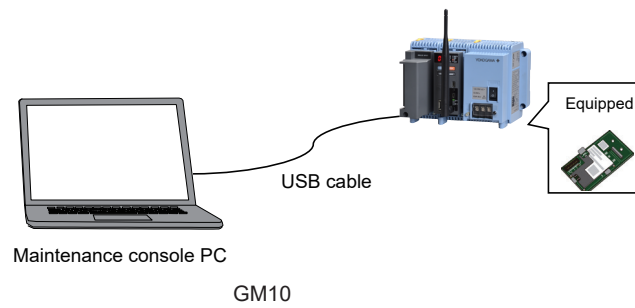
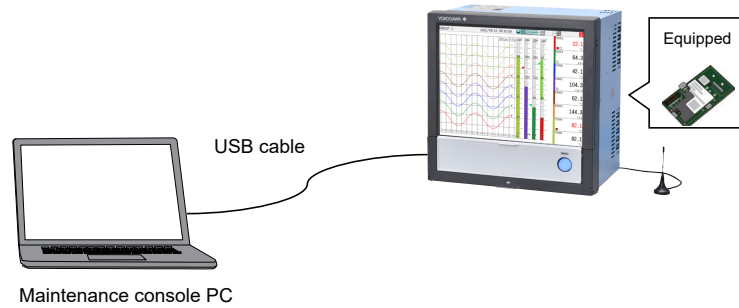

4.3.2 Starting and Closing the Maintenance Console

■ Starting the maintenance console

On the maintenance console PC's desktop, double-click MH920 Console International (shortcut icon).

The maintenance console's main window appears.

■ Closing the maintenance console

In the maintenance console's main window, click **Menu** and then **Close** or click the × in the upper right of the window.

4.3.3 Maintenance Console's Main Window

Configuration using the maintenance console always start from this window. This window is also where you return when you finish a configuration.

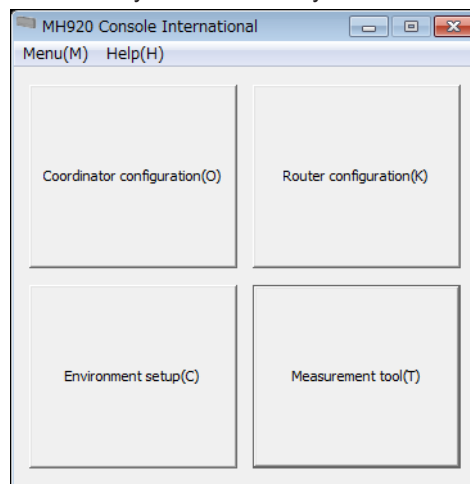

Item	Description
Coordinator configuration	A Coordinator configuration window opens. For details on the settings, see section 4.5, "Configuring the Coordinator Module," and section 4.7, "Configuring the Coordinator Module (low-speed moving bodies)."
Router configuration	A Router configuration window opens. For details on the settings, see section 4.6, "Configuring the Router Module," and section 4.8, "Configuring the Router Module (Low-Speed Moving Body)."
Environment setup	An Environment setup window opens. For details on the settings, see section 4.4, "Configuring the Maintenance Console Environment."
Measurement tool	Starts various measurement tools. For the procedure, see section 4.10, "Measurement Tool."

4.4 Configuring the Maintenance Console Environment

4.4.1 Environment Setup Window

Use the Environment setup window to configure the operating environment of the maintenance console PC.

How to open this window:

- In the main window, click **Environment setup**.
- In the main window, click **Coordinator configuration**. In the coordinator configuration selection window, click the **Environment setup** menu.
- In the main window, click **Router configuration**. In the router configuration selection window, click the **Environment setup** menu.

MH920 Console International - Environment Setup

COM port
Set the COM port the software communicates with the module.

COM port

Password
Set the password for connecting to the module. (5 to 8 digits)

New password

New password (confirmation)

Omit password
Automatically use this password when connecting to the module.

Omit password No Yes

Country
Select a country where the radio device is to be used.

Country

4.4 Configuring the Maintenance Console Environment

Item		Description
COM port		Set the COM port that the maintenance console and the wireless communication module will communicate through. Click Set to set the entered information and save it in the maintenance console PC.
Password	New password	Enter the password for connecting the maintenance console to the wireless communication module (5 to 8 characters).
	New password (confirmation)	Enter the password you entered in New password again for confirmation.
		Click Set to set the entered password in the wireless communication module. From this point, enter this password when connecting to the wireless communication module. * To apply the settings to the wireless communication module, restart the module by turning the power off and then back on or by pressing the reboot switch.
Omit password	<p>If you enable this option, the password for connecting the maintenance console to the wireless communication module can be omitted.</p> <ul style="list-style-type: none"> The default password is "mh920". After connecting for the first time, be sure to change the password. <p>No: You will need to enter the password every time you connect to the wireless communication module.</p> <p>Yes: You will not need to enter the password for connecting to the wireless communication module.</p> <p>If you select Yes, enter the password for connecting the maintenance console set in the wireless communication module in the box on the right.</p> <p>Click Set to set the entered information and save it in the maintenance console PC.</p> <p>* The password set here is used for connecting to all wireless communication modules. As such, when using this function, the password for connecting the maintenance console set in the wireless communication modules must all be the same.</p>	
Country	Select a country where the radio device is to be used.	

Note

If a message "Login failed" appears even when Omit password is enabled, the omit password may still be set to the old password. When you change the password, be sure to also change the password for omit password.

■ Closing Environment setup

Click × in the upper right to return to the main window.

4.5 Configuring the Coordinator Module

This section explains the configuration of a coordinator module when routers are installed in fixed locations. When using wireless devices as low-speed moving bodies, see section 4.7, "Configuring the Coordinator Module (low-speed moving bodies)."

4.5.1 Setup Procedure

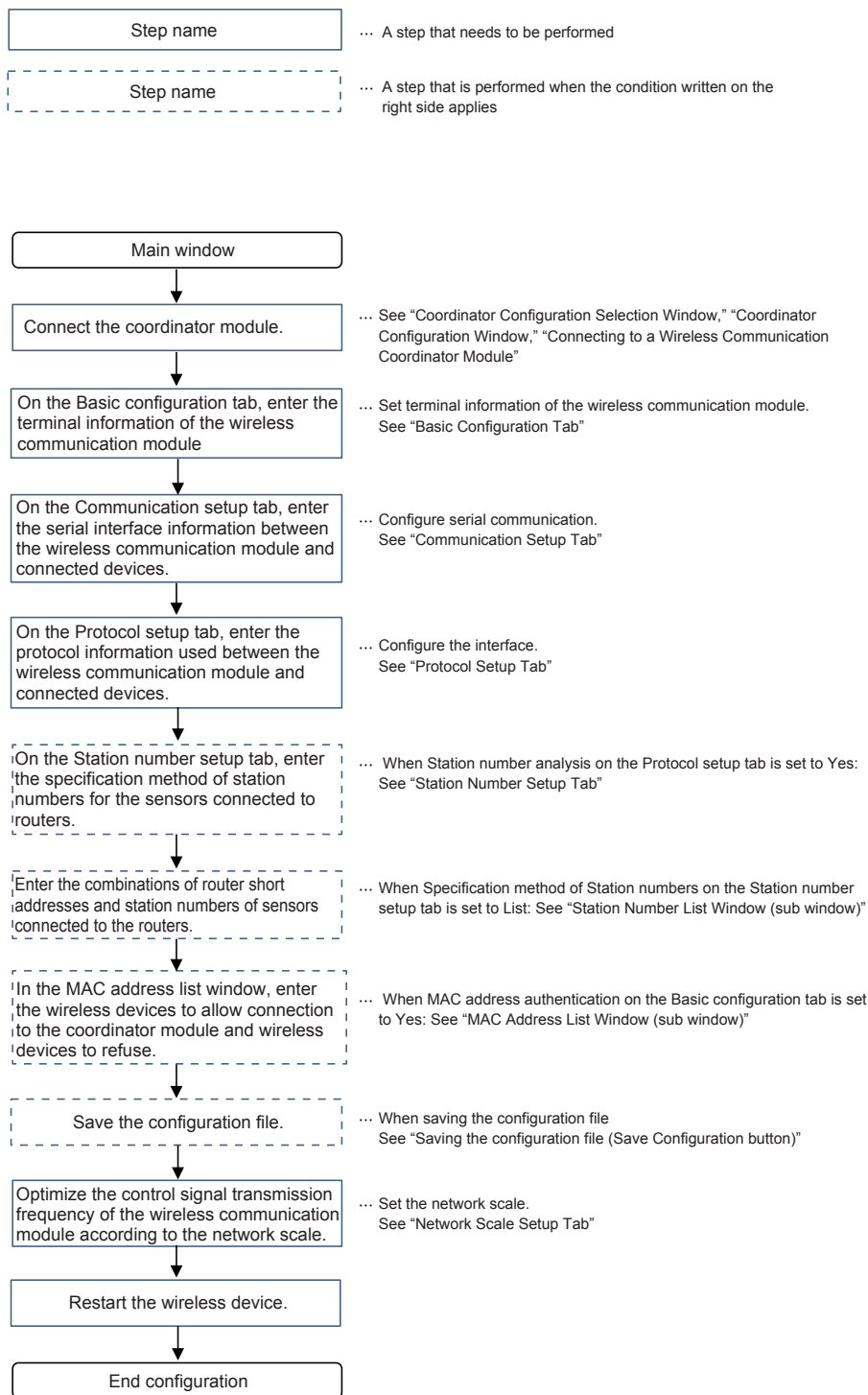

4.5.2 Coordinator configuration selection window

Use the coordinator configuration selection window to display the coordinator module configuration window or display the status.

How to open this window:

- In the main window, click **Coordinator configuration**.

You can also open this window by clicking **Menu** and then **Coordinator configuration** in the router configuration selection window.

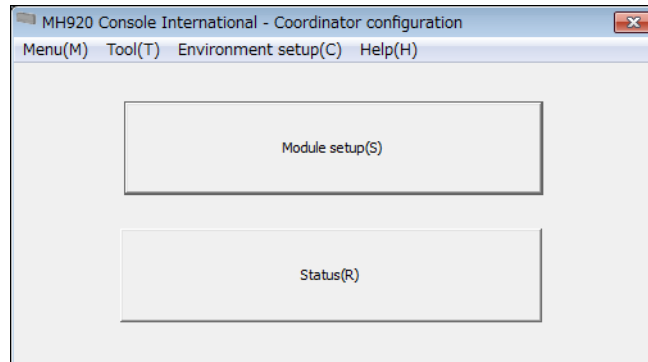

■ **Buttons**

Item	Description
Module setup	A Coordinator configuration window opens.
Status	A coordinator status window opens.

■ **Menu bar**

You can use the menu bar to switch to the router configuration selection window, Environment setup window, or main window, update the firmware, and so on.

	Item	Description
Menu	Coordinator configuration	This is not available because the window is already open.
	Router set up	A router configuration selection window opens.
	Exit	Closes the coordinator configuration selection window and returns to the main window.
Tool	Display topology	A Display topology window opens.
	Get Log	A Get log window opens.
	Firmware update	A Firmware update window opens.
	Network scale setup	A Network scale setup window opens.
	Cancel radio transmission time display	A cancel radio transmission time display window opens.
	Restore factory preset	Restores the settings of the connected wireless device to their factory defaults.
	Environment setup	An Environment setup window opens.

For details on how to use the various functions (windows) accessible from the Tool menu, see section 4.9, “Other Functions (Tool menu).”

4.5.3 Coordinator Configuration Window

In the Coordinator configuration window, you can configure the wireless communication module and set various terminal information.

How to open this window:

- In the main window, click **Coordinator configuration**. In the coordinator configuration selection window, click **Module setup**.

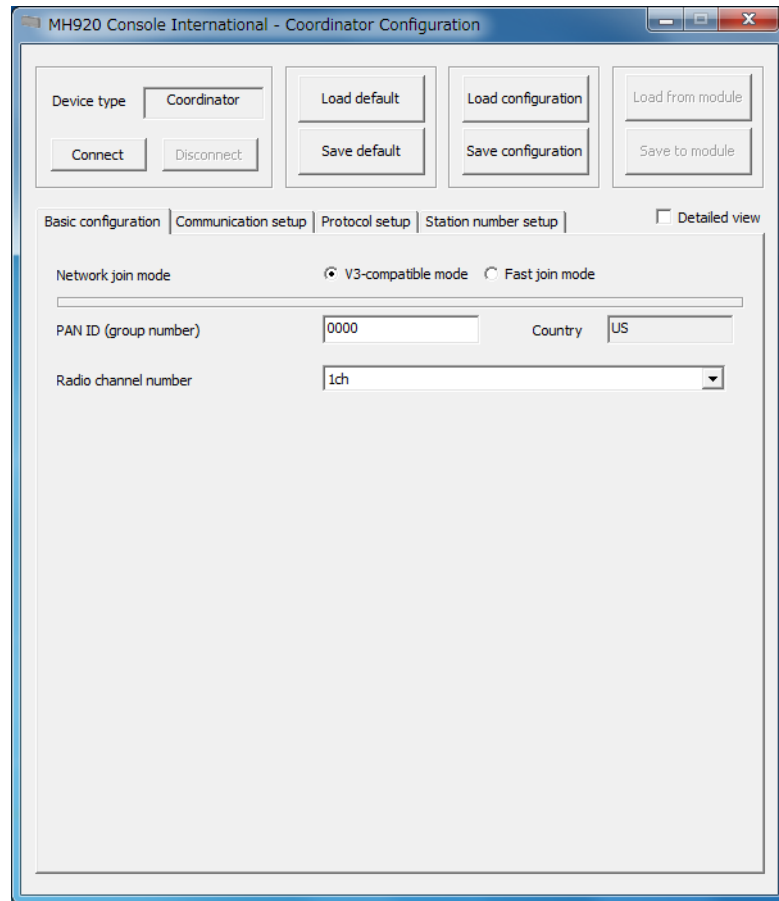

In the top area of the Coordinator configuration window, buttons for connecting and disconnecting the wireless communication module, buttons for loading and saving value set in the wireless communication module, and buttons for loading and saving configuration files are available.

The Coordinator configuration window also has the following configuration tabs. Click the tabs to configure the various settings.

- Basic configuration tab
- Communication setup tab
- Protocol setup tab
- Station number setup tab

Note

- * To apply the settings entered on the tabs of the Coordinator configuration window to the wireless communication module, click **Save to module**, and then restart the module by turning the main unit's power off and then back on or by pressing the reboot switch.
- Entering zeros for the MH920 Console International settings causes those settings to be deleted. Be sure to enter non-zero values in all the settings.

4.5 Configuring the Coordinator Module

■ Saving default values (Save default button)

Click **Save default** after setting the terminal information to save the various values as maintenance console's default values.

The information on each of the Basic configuration, Communication setup, Protocol setup, and Station number setup tabs and the Detailed view check box state are saved here. The default values that are saved can be loaded into the corresponding settings in the maintenance console by clicking **Load default**.

■ Loading default values (Load default button)

Click **Load default** to load the maintenance console's default values and shows them in the corresponding settings.

Load default loads the content of the file containing the maintenance console's default values. This file is automatically loaded when the Coordinator configuration is opened. Save default can be used to save the entered values as the maintenance console's default values. You can load the saved default values, change a portion of the settings, and use them.

■ Saving the configuration file (Save Configuration button)

Click to **Save Configuration** after setting the terminal information to save the information on each of the Basic configuration, Communication setup, Protocol setup, and Station number setup tabs in a configuration file.

The file that is saved using Save Configuration can be loaded into the corresponding settings in the maintenance console by clicking **Load Configuration**.

The configuration file is saved with the specified file name in the specified folder. By default, the file is saved with the following file name in the following folder.

- C:\OKI\MH920 Console International\Setting_Files\CM_MAC address_date and time.csv
- * The MAC address is set to 0000000000000000 if the file is saved without a wireless module connected.

■ Loading the configuration file (Load Configuration button)

Click **Load Configuration** to load a configuration file created in advance and show the content of the file in the Maintenance console window. When a configuration file is loaded, the information on each of the Basic configuration, Communication setup, Protocol setup, and Station number setup tabs is loaded. Do not load a configuration file when using the product for the first time after purchase or after resetting the settings to their factory defaults (be sure to save the settings first before loading them).

For details on the configuration file, see chapter 4, "Configuration File."

■ Closing the Coordinator configuration window

Click × in the upper right to return to the coordinator configuration selection window.

You cannot close the Coordinator configuration window while the wireless communication coordinator module is connected.

Connecting to the Wireless Communication Coordinator Module

When you connect the maintenance console to a wireless communication module, the module information can be displayed in the Coordinator configuration window and apply the settings you set in the Coordinator configuration window to the module.

■ Connecting to the wireless communication coordinator module (Connect button)

Click **Connect** in the top area of the Coordinator configuration window to connect to the wireless communication module.

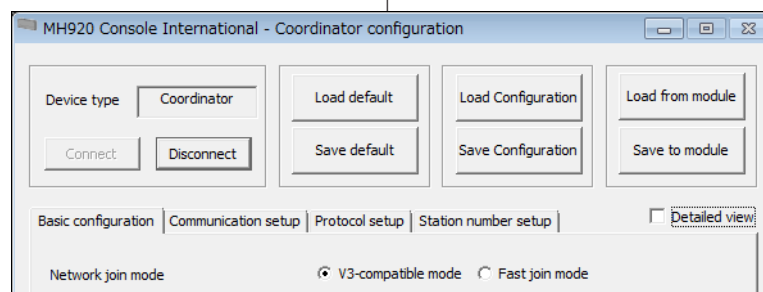
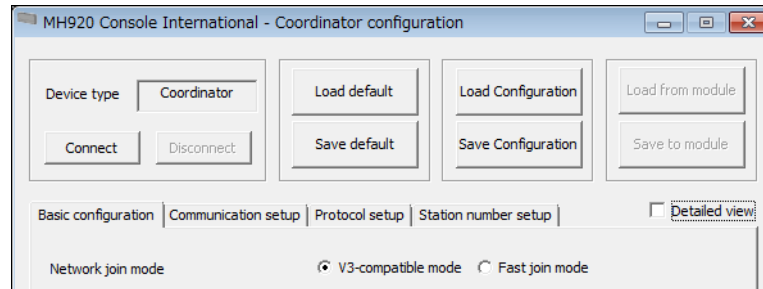

■ If Omit Password is set to No

If Omit password is set to No in the Environment setup window, a dialog box for entering the password appears. Enter the password you set in the Environment setup window, and click **Connect**.

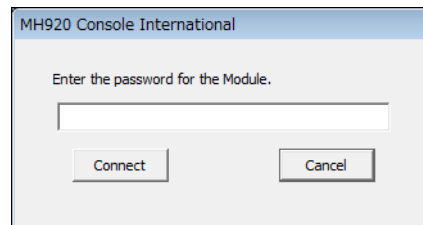

Item	Description
Password	Enter the password. <ul style="list-style-type: none"> The default password is "mh920".

This procedure also applies in other windows when a connection needs to be established with the wireless communication module.

Disconnecting from the Wireless Communication Coordinator Module

Click **Disconnect** in the top area of the Coordinator configuration window to disconnect from the wireless communication module.

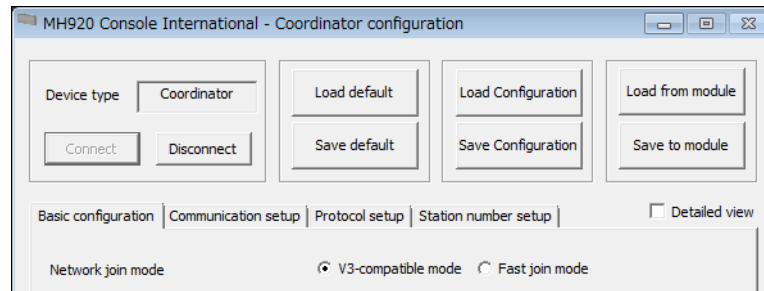

Note

Do not remove the USB cable or cut off the power supply when the maintenance console is connected to a wireless communication module. If you perform these acts while data is being written to the wireless communication module (during firmware updating or configuration), the configuration information may become corrupted.

Setting the Terminal Information of the Wireless Communication Module (Basic configuration tab)

Set terminal information of the wireless communication module.

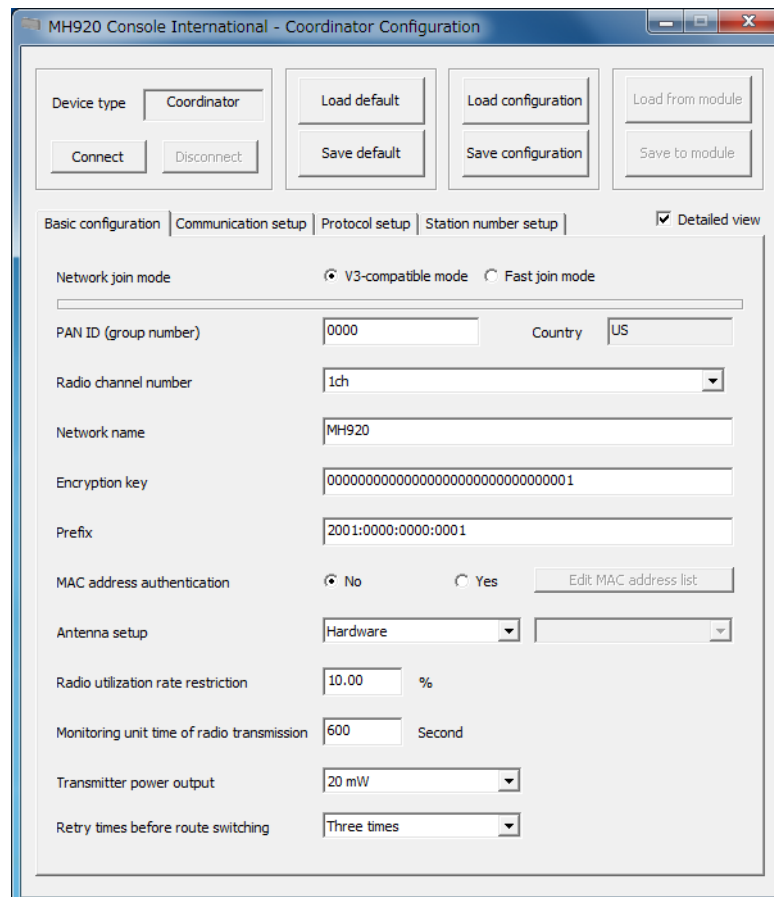

The following figure shows the window with the Detailed view check box selected. If you remove the Detailed view check box, only the items with a check mark in the Simple view column of the next table are displayed.

■ Setting the terminal information

Set the following items. Click **Save to module** to apply the set information to the wireless communication module.

Item	Description	Simple view
Network Join Mode Module setup	Set the network join mode (Fast join mode or V3-compatible mode). If there are wireless devices with firmware version v3.x in the network, select V3-compatible mode .	✓
Preferred PAN ID to connect to (group number)	Enter the preferred PAN ID (0001 to FFFE) to connect to. • To not specify the preferred PAN ID, enter "0000".	✓
Radio channel number	Select the channel number (1 to 43 ch or 1 to 14 ch).	✓
Network name	Enter using up to 16 alphanumeric characters.	
Encryption key	Enter the network encryption key (hexadecimal: 32 digits).	
Prefix	Enter the higher 64 bits of the IPv6 address. (*1)	
MAC address authentication	Select whether to perform MAC address authentication. • If you select Yes, the allow radio device list and refuse radio device list are enabled.	
Antenna setup	Select Hardware or Software . Hardware is fixed to External antenna. If you select Software, the list on the right is enabled allowing you to select the antenna to use and diversity. In addition, the antenna setup specified on the maintenance console is applied to the measurement tool transmission test. The available settings are as follows: • Internal * • External • Diversity (external + internal) • Diversity (external + external) * Do not select this option.	
Radio utilization rate restriction	0.00 to 99.99 % Default: 10.00 %	
Monitoring Unit Time of Radio Transmission	Enter the monitoring unit time of radio transmission utilization rate (10 to 3600 seconds).	
Transmitter power output	Select the signal level (0.16 mW, 1 mW, 20 mW) for the US radio transmission. Select the signal level (0.16 mW, 1 mW, 5 mW, 12.5mW) for the Korea radio transmission. In addition, the transmitter output specified on the maintenance console is applied to the measurement tool transmission test.	
Retry times before route switching	Set the number of retries (1, 2, 3) before switching the communication route when communication fails from the coordinator to a router.	

If you change the network join mode, a message for confirming the change appears. When you select Yes, the change is applied to the wireless communication module.

*1: When terminal information is obtained before the first configuration after purchase or after resetting the settings to their factory defaults, be sure to set the prefix.

Note

We recommend you change the network name, PAN-ID, encryption key, and channel number from the default values set in the MH920 Console International.

4.5 Configuring the Coordinator Module

■ Loading the current settings from the wireless communication module

Click **Load from module** to load the current settings from the wireless communication module. You can change the terminal information based on the loaded information.

Note

- The factory default Network join mode is V3-compatible mode.

Configuring Serial Communication (Communication setup tab)

Configure the serial communication settings between the wireless communication module and devices.

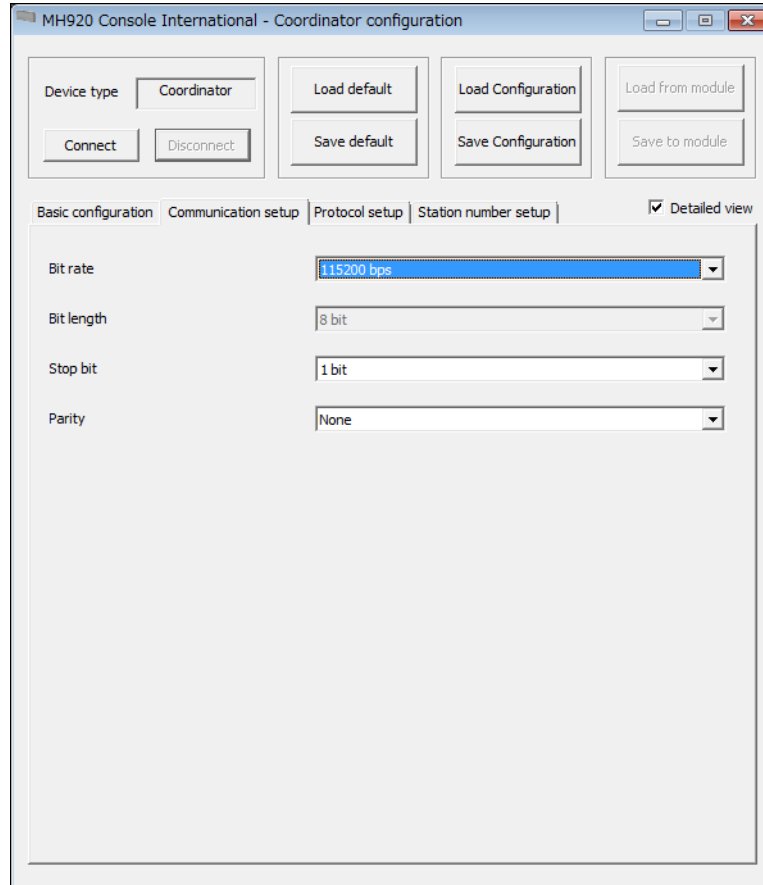

The items on the Communication setup tab are the same regardless of whether the Detailed view check box is selected.

■ Setting the information

Set the following items. Click **Save to module** to apply the set information to the wireless communication module.

Item	Description
Bit rate	Select 115200 bps.
Bit length	The bit length is fixed to 8 bit.
Stop bit	Select the stop bit (1 bit).
Parity	Select the parity (None).

■ Loading the current settings from the wireless communication module

Click **Load from module** to load the current settings from the wireless communication module. You can change the interface information based on the loaded information.

Configuring the Interface (Protocol setup tab)

Set the interface information (protocol) used between the wireless communication module and the connected device.

The screenshot shows the 'MH920 Console International - Coordinator configuration' window. The 'Protocol setup' tab is active. The 'Detailed view' checkbox is checked. The configuration options are as follows:

- Device type: Coordinator
- Buttons: Connect, Disconnect, Load default, Save default, Load Configuration, Save Configuration, Load from module, Save to module.
- Station number analysis: Yes
- Data transmission interval when transmitting to all the child devices: 3 x 100 ms
- Protocol type: Other(ASCII)
- ModBus(RTU)
 - Presence of broadcast address: No
- Other(ASCII)
 - Start character code 1: Yes, 25
 - Start character code 2: Yes, 3C
 - Condition of start character code: Or
 - Station number start position after start character code: 0 bytes
 - Station number store area: 2 bytes
 - Station number size: 2 bytes

The following figure shows the window with the Detailed view check box selected. If you remove the Detailed view check box, only the items with a check mark in the Simple view column of the next table are displayed.

4.5 Configuring the Coordinator Module

■ Setting the information

Set the following items. Click **Save to module** to apply the set information to the wireless communication module.

Item		Description	Simple view
Station number analysis (*1)		For the coordinator, set Station number analysis to No or Yes. The settings for the station number analysis selected here are enabled.	✓
Data transmission interval when transmitting to all the child devices (*2)		If Station number analysis is set to No, set the interval for transmitting data from the coordinator to each router. The factory default value is 3. (Setting range: 1 to 50 (×100 milliseconds))	
Protocol type		Select the protocol type (Modbus (RTU)). The settings for the protocol type selected here are enabled.	✓
Station number analysis Yes/Modbus (RTU)	Presence of broadcast address	This is enabled only when Protocol type is set to Modbus (RTU). Set whether a broadcast address is available, and if yes, enter the address (decimal: 0 to 255).	

*1: If Station number analysis is set to No, the coordinator sends commands to all routers in the network, excluding dedicated repeaters without connected terminals and waits for the responses from relevant routers. With this method, there is no need to associate the short address station numbers of routers. For dedicated repeaters without connected terminals, set Equipment Connection to No on the Communication setup tab of the router to prevent data transmission.

*2: If the size of the data to be transmitted is large, the transmission interval may be longer than the specified transmission interval time. In addition, if the transmission frequency is increased, the 10% duty transmission time limit may be exceeded.

Item		Description	Simple view
Station number analysis Yes No Common	Packet filtering (*1)	Set the packet filtering function to None, Yes (notification type), or Yes (polling type). If set to Yes (polling type), delayed packets and the like are discarded according to filter timeouts that occur during polling (coordinator to router to coordinator). If set to Yes (notification type), delayed packets and the like in the data transmission in one direction (coordinator to router or router to coordinator) are discarded.	
	Filter timeout on polling	Set the value to 1 second less than the value set in the main unit. Filtering is performed using the timeout value calculated in the device. Be sure to set a value no less than 1 second. The factory default value is 40. (Setting range: 10 to 600 (×100 milliseconds))	

*1: Set the packet filtering to the same value (No, Yes (notification type), or Yes (polling type)) for all wireless devices in the same network.

■ **Loading the current settings from the wireless communication module**

Click **Load from module** to load the current settings from the wireless communication module. You can change the protocol setup based on the loaded information.

Station number setup tab

Set the specification method of station numbers for devices connecting to routers.

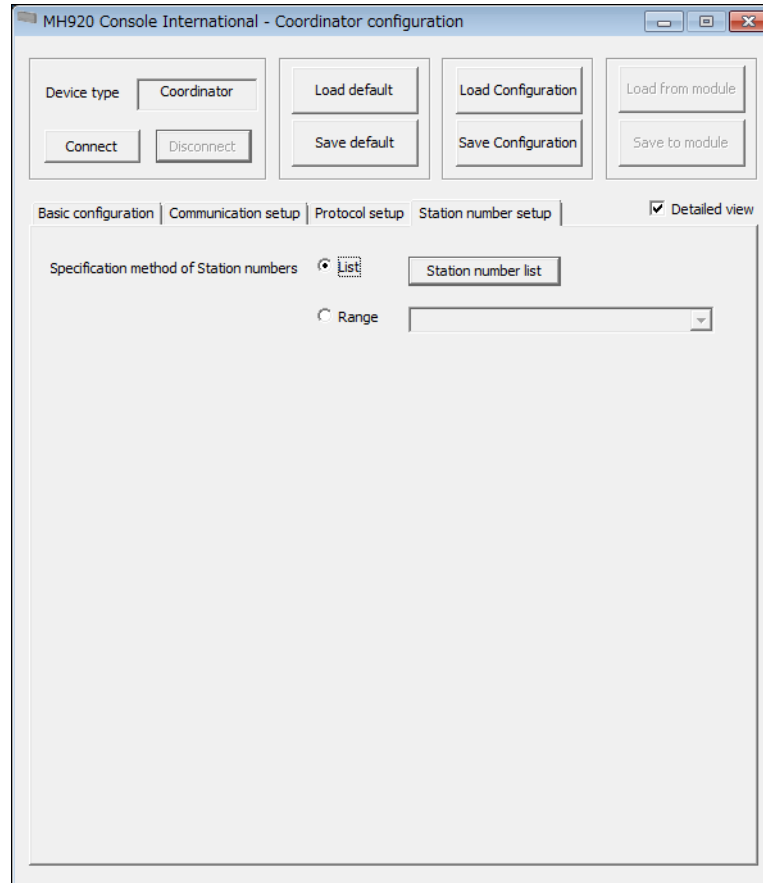

The items on the Station number setup tab are the same regardless of whether the Detailed view check box is selected.

4.5 Configuring the Coordinator Module

■ Setting the terminal information

Set the following items. Click **Save to module** to apply the set information to the wireless communication module.

Item	Description
Specification method of Station numbers	Select the specification method of Station numbers (List, Range). (*) <ul style="list-style-type: none">• If you select List, click Station number list to open a Station number list window, and set the station number list. In the Station number list window, register combinations of routers' short addresses and station numbers of devices connecting to the routers.• If you select Range, select the maximum number of multidrops (1/1 to 4/1 to 8/1 to 16/1 to 31).

*: To use no station number analysis mode, set **Station number analysis** to No on the Protocol setup tab.

■ Loading the current settings from the wireless communication module

Click **Load from module** to load the current settings from the wireless communication module. You can change the terminal information based on the loaded information.

4.5.4 MAC Address List Window (sub window)

In the MAC address list window, you can set wireless devices to allow connection to the wireless communication coordinator module and wireless devices to refuse.

How to open this window:

- In the main window, click **Coordinator configuration**. In the coordinator configuration selection window, click **Module setup**. In the Coordinator configuration window, click the **Basic configuration** tab and then **Edit MAC address list**.

You can enable the **Edit MAC address list** button by setting **MAC address authentication** to Yes on the Basic configuration tab of the Coordinator configuration window. Click **Edit MAC address list** to open a MAC address list window where you can set the allow radio device list and refuse radio device list.

The MAC address list window contains the following two tabs:

- Allow radio device list
- Refuse radio device list

Allow radio device list tab

In the wireless communication coordinator module, set the MAC addresses and the encryption key for encrypted communication for routers that you want to allow joining the wireless network. You can also load settings from the wireless communication module and save the settings you enter here in a configuration file.

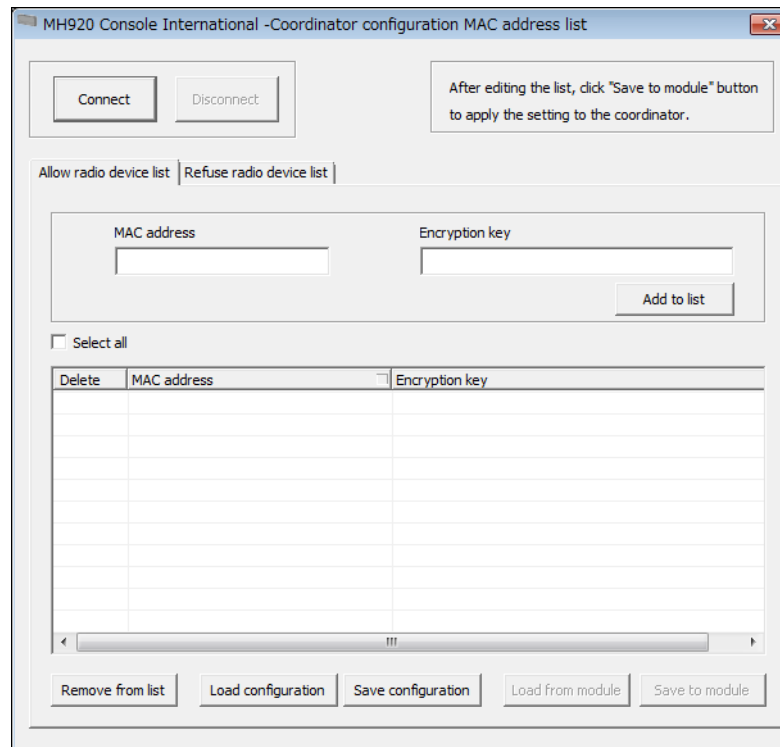

4.5 Configuring the Coordinator Module

■ To set the allow radio device list

Enter the following items to create the allow radio device list. Click **Save to module** to apply the allow radio device list to the wireless communication module.

Item	Description
MAC address	Enter the MAC address (64 bits) of the router you want to add to the allow radio device list. Click Add to list to add the address along with the information entered in the Encryption key box to the list.
Encryption key	Enter the encryption key (hexadecimal: 32 digits) of the router you want to add to the allow radio device list. Click Add to list to add the key along with the information entered in the MAC address box to the list.

■ To delete information from the allow radio device list

Enter a check mark in the Delete column of the entry you want to delete, and click **Remove from list**. The selected entry is deleted from the list. Click **Save to module** to apply the allow radio device list to the wireless communication module.

Select the **Select all** check box to enter check marks in the Delete column of all entries.

■ Loading the current settings from the wireless communication module

Click **Load from module** to load the current settings from the wireless communication module. You can change the allow radio device list based on the loaded information.

■ To save the allow radio device list

After setting the allow radio device list, click **Save configuration**. The allow radio device list (MAC addresses and encryption keys) is saved with the specified file name in the specified folder. By default, the file is saved with the following file name in the following folder.

- C:\OKI\MH920 Console International\Node_Log\MAC address _MacList_date and time.csv
- * The MAC address is omitted if the file is saved without a wireless module connected.

■ To Load the allow radio device list from a configuration file

Click **Load Configuration** to load a configuration file containing the allow radio device list (MAC addresses and encryption keys) and show the content of the file in the Maintenance console window.

Refuse radio device list tab

In the wireless communication coordinator module, set MAC addresses of routers that you want to prevent from joining the wireless network.

■ To set the refuse radio device list

Enter the following items to create the refuse radio device list. Click **Save to module** to apply the refuse radio device list to the wireless communication module.

Item	Description
MAC address	Enter the MAC address (64 bits) of the router you want to add to the refuse radio device list. Click Add to list to add the entry to the list.

Select the **Select all** check box to enter check marks in the Delete column of all entries.

Note

- The addition and deletion of wireless communication modules to refuse the connection of are applied immediately without the restarting of the coordinator module. However, if MAC address authentication is registered for the first time, you must restart the coordinator module.
- If you want to refuse the connection of a wireless communication module that is already connected, add the module to the wireless device list and then disconnect the applicable wireless communication module such as by restarting the wireless communication coordinator module.

4.5 Configuring the Coordinator Module

■ Loading the current settings from the wireless communication module

Click **Load from module** to load the current settings from the wireless communication module. You can change the refuse radio device list based on the loaded information.

■ To save the refuse radio device list

After setting the refuse radio device list, click **Save configuration**. The refuse radio device list is saved with the specified file name in the specified folder. By default, the file is saved with the following file name in the following folder.

- C:\OKI\MH920 Console International\Node_Log\MAC address_BlackList_date and time.csv

* The MAC address is omitted if the file is saved without a wireless module connected.

■ To Load the refuse radio device list from a configuration file

Click **Load Configuration** to load a configuration file containing the refuse radio device list and show the content of the file in the Maintenance console window.

4.5.5 Station Number List Window (sub window)

In the Station number list window, register combinations of routers' short addresses and station numbers of devices connected to the routers.

How to open this window:

- In the main window, click **Coordinator configuration**. In the coordinator configuration selection window, click **Module setup**. In the Coordinator configuration window, click the **Station number setup** tab and then **Station number list**.

You can enable the **Station number list** button by setting the **Specification method of Station numbers** to List on the Station number setup tab of the Coordinator configuration window. Click **Station number list** to open a Station number list window.

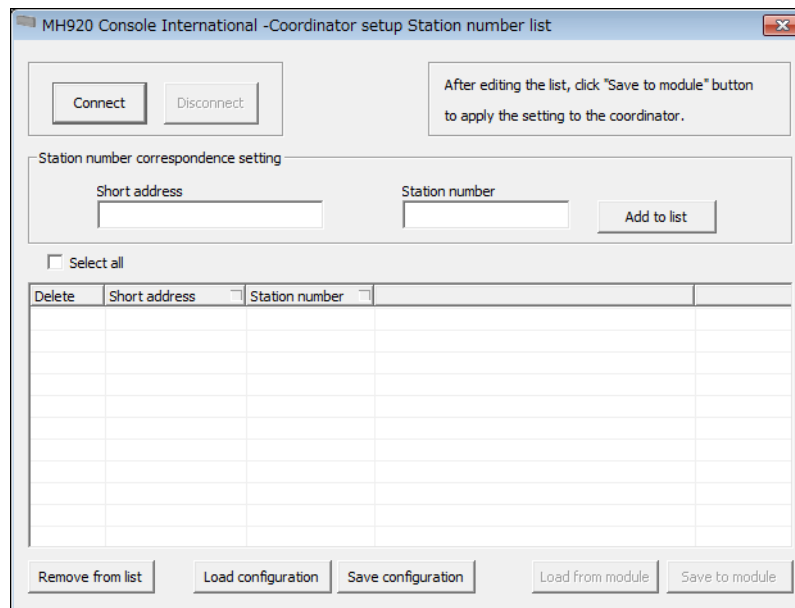

MH920 Console International -Coordinator setup Station number list

Connect Disconnect

After editing the list, click "Save to module" button to apply the setting to the coordinator.

Station number correspondence setting

Short address Station number

Add to list

Select all

Delete	Short address	Station number

Remove from list Load configuration Save configuration Load from module Save to module

■ To register a station number list

Enter the following items to create the station number list. Click **Save to module** to apply the contents of the station number list to the wireless communication module.

Item	Description
Short address	Enter the short address (0001 to FFFD) of the router you want to add to the list. Click Add to list to add the address along with the information entered in the Station number box to the list.
Station number	Enter the station number corresponding to the router's short address. Click Add to list to add the station number along with the information entered in the Short address box to the list.

Note

If you register the station number list when there is no list in the MH920 Console International or when a station number list has not been loaded from the wireless communication module, the station number list registered in the wireless communication module will be deleted.

■ To delete information from the station number list

Enter a check mark in the Delete column of the entry you want to delete, and click **Remove from list**. The selected entry is deleted from the list. Click **Save to module** to apply the contents of the station number list to the wireless communication module.

■ Loading the current settings from the wireless communication module

Click **Load from module** to load the current settings from the wireless communication module. You can change the station number list based on the loaded information.

Note

Before loading the current settings from the wireless communication module, perform either of the procedures below.

- Connect a wireless communication module with updated configuration, and then load the settings by using **Load from module** in the Coordinator configuration window. For details, see "Loading the current settings from the wireless communication module" in "Configuring the Interface (Protocol setup tab)".
- Load the setting from a configuration file saved in advance by using **Load Configuration** in the Coordinator configuration window. For details, "Loading the configuration file (Load Configuration button)" in the Coordinator configuration window.

■ To save the station number list you edited

After setting the station number list, click **Save configuration**. The station number list is saved with the specified file name in the specified folder. By default, the file is saved with the following file name in the following folder.

- C:\OKI\MH920 Console International\Node_Log\MAC address_p3_NumList_date and time.csv

* The MAC address is omitted if the file is saved without a wireless module connected.

■ To Load the station number list from a configuration file

Click **Load Configuration** to load a configuration file containing the station number list and show the content of the file in the Maintenance console window.

4.5 Configuring the Coordinator Module

Note

- Before loading the station number list from a con, perform either of the procedures below.
- Connect a wireless communication module with updated configuration, and then load the settings by using **Load from module** in the Coordinator configuration window. For details, see “Loading the current settings from the wireless communication module” in “Configuring the Interface (Protocol setup tab)”.
 - Load the setting from a configuration file saved in advance by using **Load Configuration** in the Coordinator configuration window. For details, “Loading the configuration file (Load Configuration button)” in the Coordinator configuration window.

4.5.6 Status Window

The status window shows the wireless communication coordinator module information.

How to open this window:

- In the main window, click **Coordinator configuration**. In the coordinator configuration selection window, click **Status**.

Clicking Status automatically establishes a connection with the wireless communication module and shows a message indicating that status information will be loaded from the wireless communication module.

Click **Yes** to open a Status window.

If a password prompt window appears, see “If Omit Password is set to No” in section 4.5.3, “Coordinator Configuration Window.”

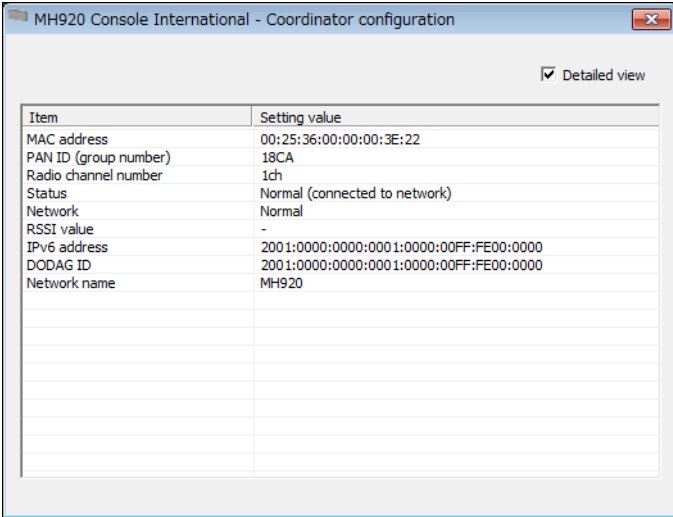

Item	Setting value
MAC address	00:25:36:00:00:3E:22
PAN ID (group number)	18CA
Radio channel number	1ch
Status	Normal (connected to network)
Network	Normal
RSSI value	-
IPv6 address	2001:0000:0000:0001:0000:00FF:FE00:0000
DODAG ID	2001:0000:0000:0001:0000:00FF:FE00:0000
Network name	MH920

The following figure shows the window with the Detailed view check box selected. If you remove the Detailed view check box, only the items with a check mark in the Simple view column of the next table are displayed.

Item	Description	Simple view
MAC address	The 64 bit MAC address is displayed.	✓
PAN ID (group number)	The PAN ID in use is displayed.	✓
Radio channel number	The channel number in use is displayed.	✓
Status	The current status is displayed. <ul style="list-style-type: none"> • Normal (not connected to network) • Normal (connected to network) • Updating firmware • Alarm issued • Radio transmission time exceeded 	✓
Network	The network status is displayed. <ul style="list-style-type: none"> • No network connection • Normal • Authentication error • Radio transmission stopped • Sending serial data 	✓
RSSI value	—	✓
IPv6 address	The IPv6 address assigned to the wireless module is displayed.	
DODAG ID	The DODAG ID in use is displayed.	
Network name	The network name in use is displayed.	

4.5.7 Setting the Network Scale (Network scale setup)

Optimize the control signal transmission frequency of the wireless communication module according to the network scale.

How to open this window:

- In the main window, click **Coordinator configuration**. In the coordinator configuration selection window, click **Network scale setup** on the **Tool** menu.

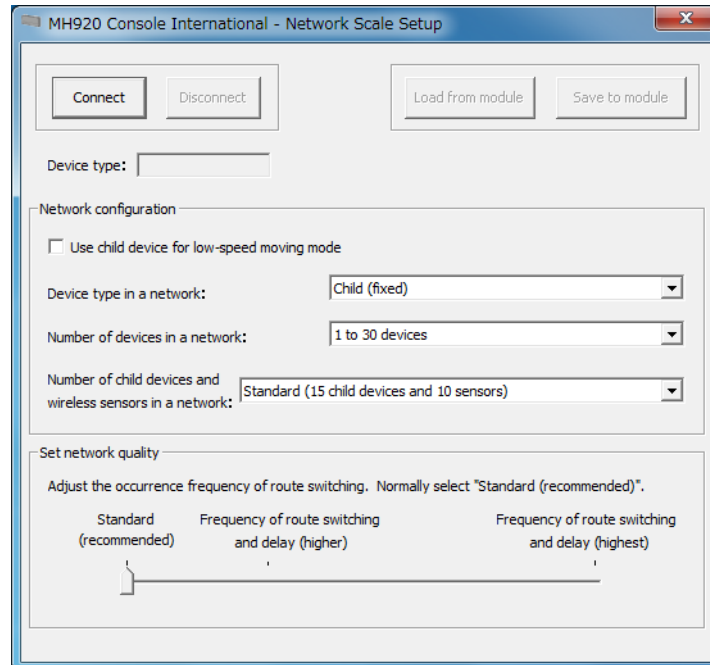

4.5 Configuring the Coordinator Module

■ Setting the information

Click **Connect**, set the following items, and click **Save to module** to apply the set information to the wireless communication module.

Item	Description
Use child device for low-speed moving mode	Do not select this check box.
Device type in a network	Select the type of device in the network from the following: <ul style="list-style-type: none">• Child (fixed)• Child (fixed) + wireless sensor: Select this to use wireless input units and the like.
Number of devices in a network	Select the number of devices in the network from the following: <ul style="list-style-type: none">• 1 to 30 devices• 31 to 60 devices• 61 to 100 devices
Number of child devices and wireless sensors in a network	Select the number of child devices and wireless sensors in the network. <ul style="list-style-type: none">• Child device only (up to 25 child devices)• Standard (15 child devices and 10 sensors)• Maximum number of wireless sensors (5 Child devices and 20 sensors)
Set network quality	Select the network quality from the following: <ul style="list-style-type: none">• Standard (recommended)• Frequency of route switching and delay (higher)• Frequency of route switching and delay (highest)

Note

- * To apply the settings entered in the Network scale setup window to the wireless communication module, click **Save to module**, and then restart the module by turning the power off and then back on or by pressing the reboot switch.
- Be sure to match the Number of devices in a network to the number of routers with the same PAN ID (group number). In addition, be sure to set the same network scale for routers with the same PAN ID (group number).
- For wireless communication modules with the Network join mode set to Fast join mode, the Use child device for low-speed moving mode check box is not available.
- Match the "Device type in a network" and "Number of devices in a network" settings between the coordinator and router.

■ Loading the current settings from the wireless communication module

Click **Connect** and then **Load from module** to load the current settings from the wireless communication module. You can change the network scale based on the loaded information.

4.6 Configuring Router Modules

This section explains the configuration of router modules when routers are installed in fixed locations. When using routers as low-speed moving bodies, see section 4.8, "Configuring Router Modules (low-speed moving bodies)."

4.6.1 Setup Procedure

Configure router modules by following the procedure below.

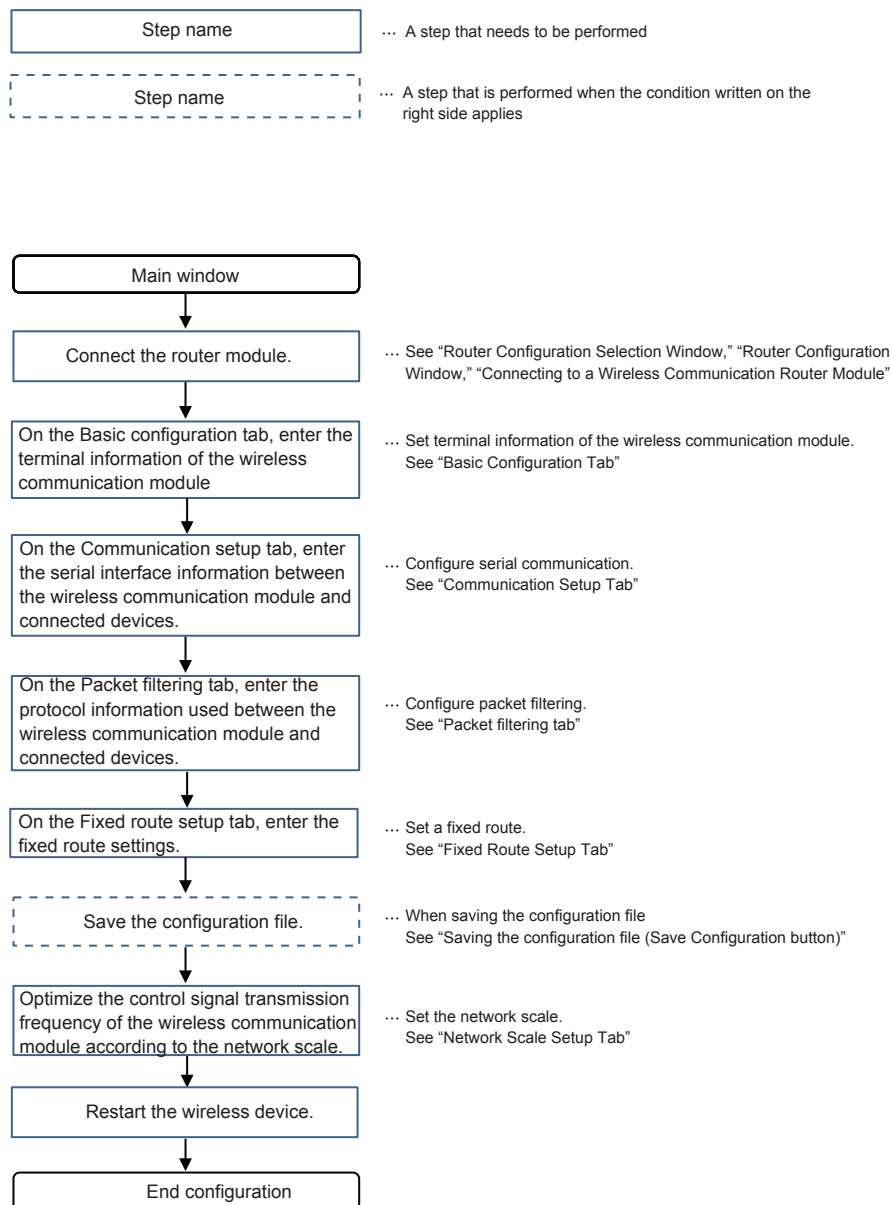

4.6.2 Router configuration selection window

Use the router configuration selection window to display the wireless communication router module configuration window or display the status.

How to open this window:

In the main window, click **Router configuration**.

You can also open this window by clicking **Menu** and then **Router configuration** in the router configuration selection window.

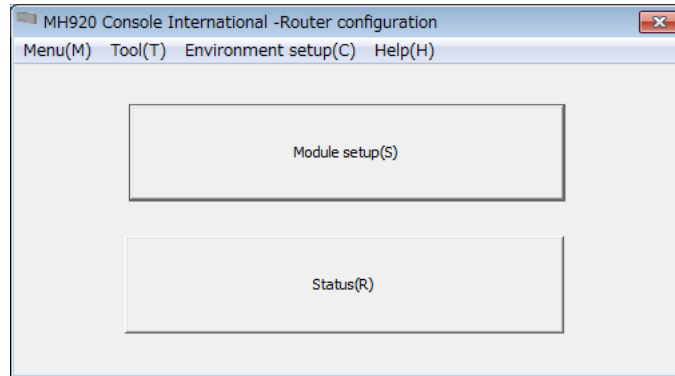

■ Buttons

Item	Description
Module setup	A Router configuration window opens.
Status	A router status window opens.

■ Menu bar

You can use the menu bar to switch to the Coordinator configuration window, Environment setup window, or main window, update the firmware, and so on.

	Item	Description
Menu	Coordinator configuration	A coordinator configuration selection window opens.
	Router set up	This is not available because the window is already open.
	Exit	Closes the router configuration selection window and returns to the main window.
Tool	Get Log	A Get log window opens.
	Firmware update	A Firmware update window opens.
	Network scale setup	A Network scale setup window opens.
	Cancel radio transmission time display	A cancel radio transmission time display window opens.
	Restore factory preset	Restores the settings of the connected wireless device to their factory defaults.
Environment setup	An Environment setup window opens.	

For details on how to use the various functions (windows) accessible from the Tool menu, see section 4.9, “Other Functions (Tool menu).”

4.6.3 Router Configuration Window

In the Router configuration window, you can configure the wireless communication module and set various types of information.

How to open this window:

- In the main window, click **Router configuration**. In the router configuration selection window, click the **Module setup** menu.

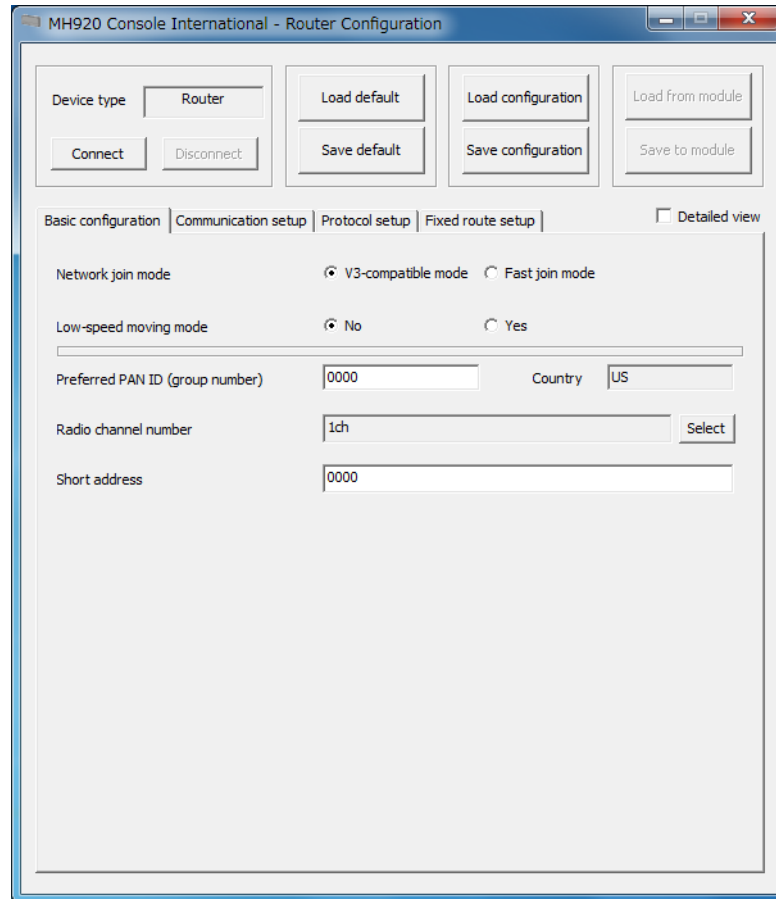

In the top area of the Router configuration window, buttons for connecting and disconnecting the wireless communication router module, buttons for loading and saving value set in the wireless communication router module, and buttons for loading and saving configuration files are available.

The Router configuration window also has the following configuration tabs. Click the tabs to configure the various settings.

- Basic configuration tab
- Communication setup tab
- Packet filtering tab
- Fixed route setup tab

Note

- * To apply the settings entered on the tabs of the Router configuration window to the wireless communication router module, click **Save to module**, and then restart the module by turning the power off and then back on.
- Entering zeros for the MH920 Console International settings causes those settings to be deleted. Be sure to enter non-zero values in all the settings.

■ Saving default values (Save default button)

Click **Save default** after setting the terminal information to save the various values as maintenance console's default values.

The information on each of the Basic configuration, Communication setup, Packet filtering, and Station number setup tabs and the Detailed view check box state are saved here. The default values that are saved can be loaded into the corresponding settings in the maintenance console by clicking **Load default**.

■ Loading default values (Load default button)

Click **Load default** to load the maintenance console's default values and shows them in the corresponding settings.

Load default loads the content of the file containing the maintenance console's default values. This file is automatically loaded when the Router configuration is opened.

Save default can be used to save the entered values as the maintenance console's default values. You can load the saved default values, change a portion of the settings, and use them.

■ Saving the configuration file (Save Configuration button)

Click to **Save Configuration** after setting the terminal information to save the information on each of the Basic configuration, Communication setup, Packet filtering, and Fixed route setup tabs in a configuration file.

The file that is saved using Save Configuration can be loaded into the corresponding settings in the maintenance console by clicking **Load Configuration**.

The configuration file is saved with the specified file name in the specified folder. By default, the file is saved with the following file name in the following folder.

- C:\OKI\MH920 Console International\Setting_Files\RM_MAC address_date and time.csv
- * The MAC address is set to 0000000000000000 if the file is saved without a wireless communication module connected.

■ Loading the configuration file (Load Configuration button)

Click **Load Configuration** to load a configuration file created in advance and show the content of the file in the Maintenance console window. When a configuration file is loaded, the information on each of the Basic configuration, Communication setup, Packet filtering, and Fixed route setup tabs is loaded.

For details on the configuration file, see chapter 5, "List of Settings."

■ Closing the Router configuration window

Click × in the upper right to return to the router configuration selection window.

You cannot close the Router configuration window while the wireless communication router module is connected.

Connecting to a Wireless Communication Router Module (Connect button)

When you connect the maintenance console to a wireless communication module, the module information can be displayed in the Router configuration window and apply the settings you set in the Router configuration window to the module.

To connect to a wireless communication router module (Connect button)

Click **Connect** in the top area of the Router configuration window to connect to the wireless communication module.

If Low-speed moving mode is set to No, Device type is set to Child (fixed).

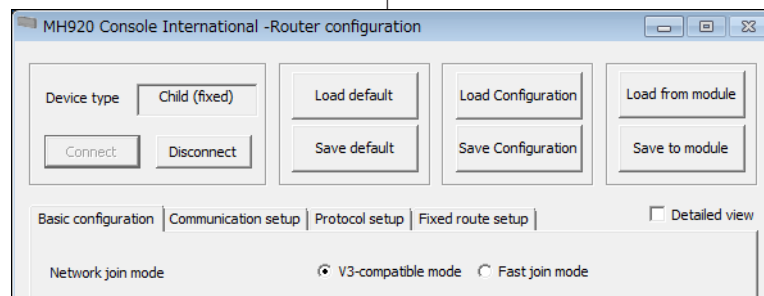
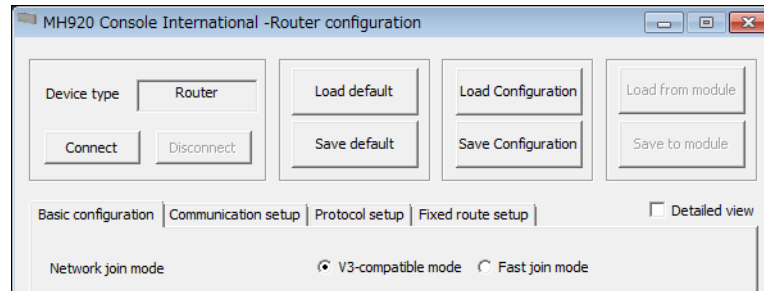

■ If Omit Password is set to No

If Omit password is set to No in the Environment setup window, a dialog box for entering the password appears. Enter the password you set in the Environment setup window, and click **Connect**.

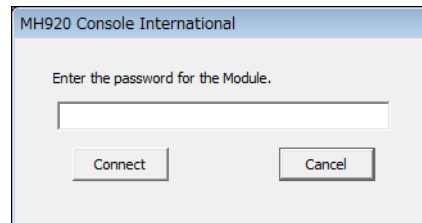

Item	Description
Password	Enter the password. <ul style="list-style-type: none"> The default password is "mh920".

This procedure also applies in other windows when a connection needs to be established with the wireless communication module.

Disconnecting from a Wireless Communication Router Module (Disconnect button)

Click **Disconnect** in the top area of the Router configuration window to disconnect from the wireless communication module.

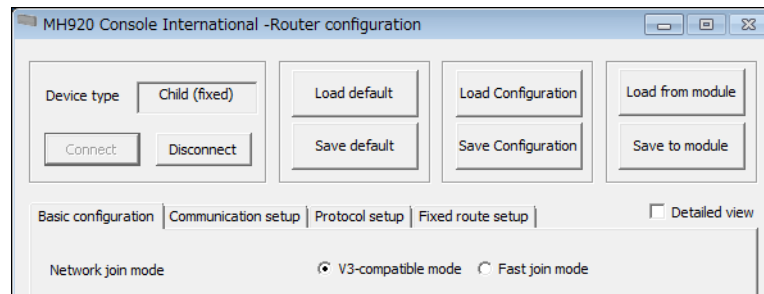

Note

Do not remove the USB cable or cut off the power supply when the maintenance console is connected to a wireless communication module. If you perform these acts while data is being written to the wireless communication module (during firmware updating or configuration), the configuration information may become corrupted.

Disconnecting from a Wireless Communication Router Module (Disconnect button)

Set terminal information of the wireless communication module.

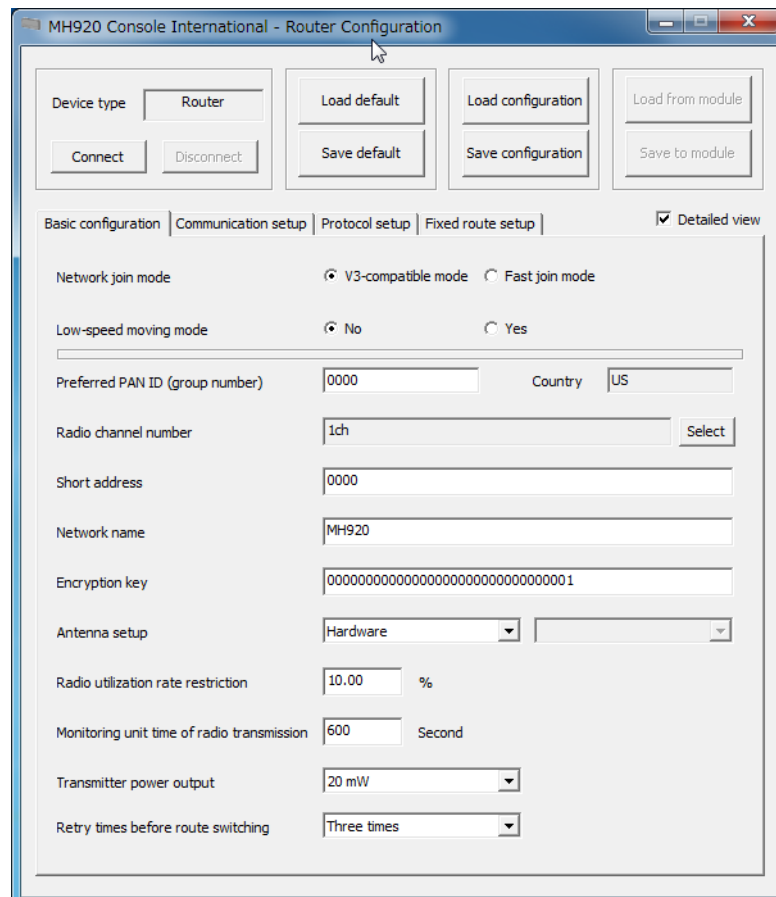

The following figure shows the window with the Detailed view check box selected. If you remove the Detailed view check box, only the items with a check mark in the Simple view column of the next table are displayed.

■ Setting the terminal information

Set the following items. Click **Save to module** to apply the set information to the wireless communication module.

Item	Description	Simple view
Network join mode	Set the network join mode (Fast join mode or V3-compatible mode). If there are wireless devices with firmware version v3.x in the network, select V3-compatible mode .	✓
Low-speed moving mode	Select No if the router module is not going to be installed in a low-speed moving body.	✓
Preferred PAN ID (group number)	Enter the preferred PAN ID (0000 to FFFE) to connect to. • To not specify the preferred PAN ID, enter "0000".	✓
Radio channel number	Select the channel number (1 to 43 ch or 1 to 14 ch). • Up to 10 channels can be selected. (*1)	✓
Short address	Enter a different short address (0001 to FFFD) for each router module. • Select a short address that does not overlap with the short addresses of the wireless sensors. • For router modules, do not set the address to 0000.	✓
Network name	Enter using up to 16 alphanumeric characters.	
Encryption key	Enter the network encryption key (hexadecimal: 32 digits).	
Antenna setup	Select Hardware or Software . Hardware is fixed to External antenna. If you select Software, the list on the right is enabled allowing you to select the antenna to use and diversity. In addition, the antenna setup specified on the maintenance console is applied to the measurement tool transmission test. The available settings are as follows: • Internal * • External • Diversity (external + internal) • Diversity (external + external) * Do not select this option.	
Radio utilization rate restriction	0.00 to 99.99 % Default: 10.00 %	
Monitoring Unit Time of Radio Transmission	Enter the monitoring unit time of radio transmission utilization rate (10 to 3600 seconds).	
Transmitter power output	Select the signal level (0.16 mW, 1 mW, 20 mW) for the US radio transmission. Select the signal level (0.16 mW, 1 mW, 5 mW, 12.5mW) for the Korea radio transmission. In addition, the transmitter output specified on the maintenance console is applied to the measurement tool transmission test.	
Retry times before route switching	Set the number of retries (1, 2, 3) before switching the communication route when communication fails from the coordinator to a router.	

If you change the network join mode, a message for confirming the change appears. When you select Yes, the change is applied to the wireless communication module.

Note

- If Network join mode is set to Fast join mode, Low-speed moving mode cannot be set to Yes.
- If Low-speed moving mode is set to Yes, Network join mode cannot be set to Fast join mode.
- We recommend you change the network name, PAN-ID, encryption key, and channel number from the default values set in the MH920 Console International.

4.6 Configuring Router Modules

■ Loading the current settings from the wireless communication module

Click **Load from module** to load the current settings from the wireless communication module. You can change the terminal information based on the loaded information.

Note

- The factory default Network join mode is V3-compatible mode, regardless of the firmware version.

Configuring Serial Communication (Communication setup tab)

Configure the serial communication settings between the wireless communication module and devices.

The screenshot shows the 'MH920 Console International - Router configuration' window. At the top, there are several buttons: 'Device type' (set to 'Router'), 'Connect', 'Disconnect', 'Load default', 'Save default', 'Load Configuration', 'Save Configuration', 'Load from module', and 'Save to module'. Below these buttons are four tabs: 'Basic configuration', 'Communication setup', 'Protocol setup', and 'Fixed route setup'. The 'Communication setup' tab is selected. To the right of the tabs is a checked 'Detailed view' checkbox. The main area of the window contains the following settings:

Equipment Connection	Yes
Bit rate	115200 bps
Bit length	8 bit
Stop bit	1 bit
Parity	None

The items on the Communication setup tab are the same regardless of whether the Detailed view check box is selected.

■ Setting the information

Set the following items. Click **Save to module** to apply the set information to the wireless communication module.

Item	Description
Equipment Connection	Select whether there are connections to devices. To use the module only as a repeater, set Equipment Connection to No.
Bit rate	Select 115200 bps.
Bit length	The bit length is fixed to 8 bit.
Stop bit	Select the stop bit (1 bit).
Parity	Select the parity (None).

■ Loading the current settings from the wireless communication module

Click **Load from module** to load the current settings from the wireless communication module. You can change the interface information based on the loaded information.

Configuring Packet Filtering (Packet filtering tab)

Configure the packet filtering settings to use between the wireless communication module and devices. Packet filtering filters unneeded data received from devices. If responses from devices take longer than the specified timeout value, the data is discarded.

The screenshot shows the 'MH920 Console International -Router configuration' window. At the top, there are several buttons: 'Device type' (set to Router), 'Connect', 'Disconnect', 'Load default', 'Save default', 'Load Configuration', 'Save Configuration', 'Load from module', and 'Save to module'. Below these are tabs for 'Basic configuration', 'Communication setup', 'Protocol setup', and 'Fixed route setup'. The 'Detailed view' checkbox is checked. Under 'Add sender identification', the 'No' radio button is selected. Under 'Packet filtering', the 'Yes (notification type)' radio button is selected. Under 'Filter timeout on polling', the value '10' is entered in a text box, followed by 'x100 ms' and an 'Update' button.

The following figure shows the window with the Detailed view check box selected. If you remove the Detailed view check box, only the items with a check mark in the Simple view column of the next table are displayed.

4.6 Configuring Router Modules

■ Setting the information

Set the following items. Click **Save to module** to apply the set information to the wireless communication module.

Item	Description	Simple view
Packet filtering	Set the packet filtering function to None, Yes (notification type), or Yes (polling type). If set to Yes (polling type), delayed packets and the like are discarded according to filter timeouts that occur during polling (coordinator to router to coordinator). If set to Yes (notification type), delayed packets and the like in the data transmission in one direction (coordinator to router or router to coordinator) are discarded.	
Filter timeout on polling (*)	Set a value that is greater than or equal to the response time from the wireless communication module to the connected devices (setting range: 0, 10 to 600 (× 100 milliseconds)). If responses from devices take longer than the specified filter timeout on polling, the data is discarded. The factory default value is 10.	

*: If you want to set Packet filtering to Yes (polling type)) in no station number analysis mode, set Filter timeout on polling to 0.

■ Loading the current settings from the wireless communication module

Click **Load from module** to load the current settings from the wireless communication module. You can change the packet filtering settings based on the loaded information.

Setting a Fixed Route (Fixed route setup tab)

You can connect the wireless communication module to a specific wireless communication module to fix the communication route.

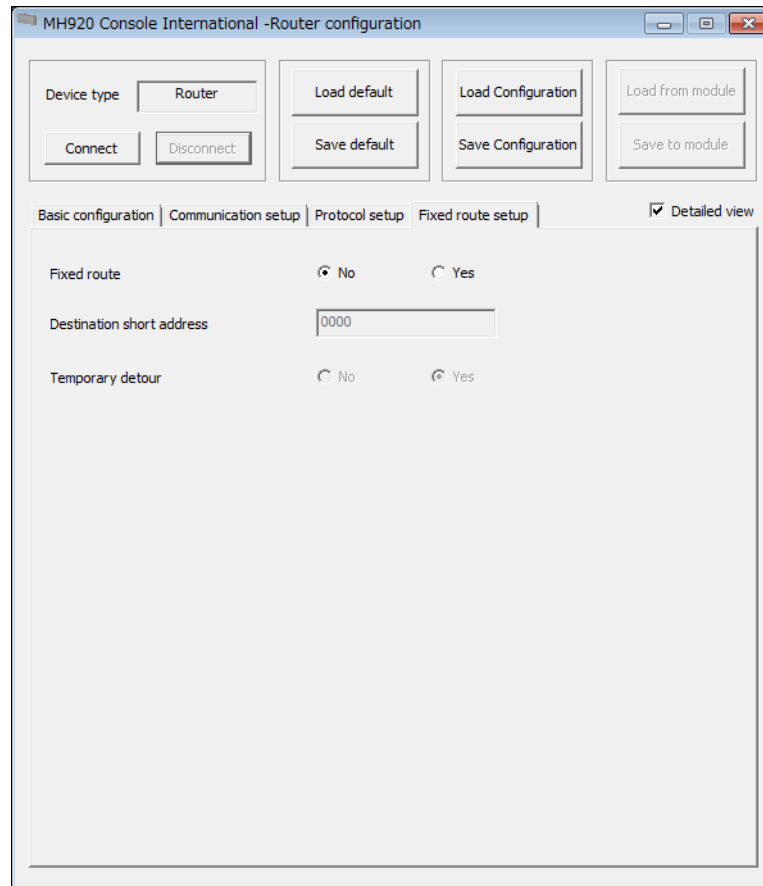

The items on the Fixed route setup tab are the same regardless of whether the Detailed view check box is selected.

■ Setting the information

Set the following items. Click **Save to module** to apply the set information to the wireless communication module.

Item	Description
Fixed route	Enables or disables the fixed route function.
Destination short address	Set the short address of the fixed connection destination.
Temporary detour	When the fixed route function is enabled, you can enable or disable detour transmission. (*)

*: When joining a network, if the radio signal of the fixed connection destination cannot be received, joining the network is not possible even if the temporary detour setting is enabled.

■ Loading the current settings from the wireless communication module

Click **Load from module** to load the current settings from the wireless communication module. You can change the fixed route based on the loaded information.

4.6.4 Status Window

The status window shows the wireless communication router module information. Before showing this window, connect to the wireless communication router module.

How to open this window:

- In the main window, click **Router configuration**. In the router configuration selection window, click **Status**.

Clicking **Router configuration** in the main window and clicking **Status** in the router configuration selection window shows a message indicating that status information will be loaded from the wireless communication module. Click **Yes** to open a Status window.

If a password prompt window appears, see “If Omit Password is set to No” in section 4.5.3, “Coordinator Configuration Window.”

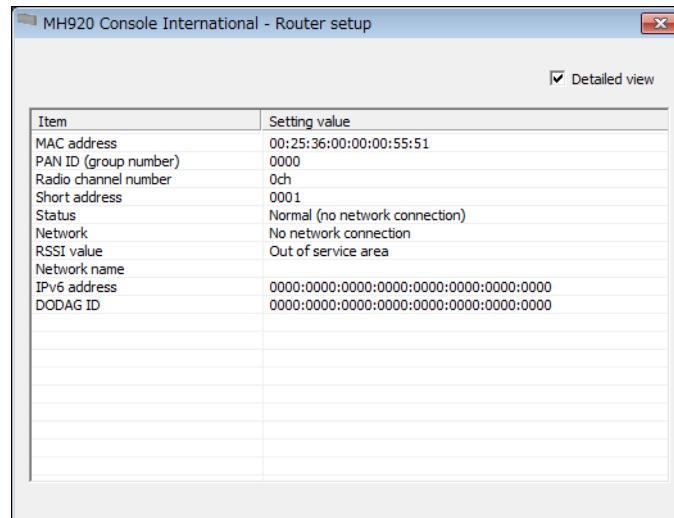

The following figure shows the window with the Detailed view check box selected.

If you remove the Detailed view check box, only the items with a check mark in the Simple view column of the next table are displayed.

Item	Description	Simple view
MAC address	A 64 bit MAC address is displayed.	✓
PAN ID (group number)	The PAN ID in use is displayed.	✓
Radio channel number	The channel number in use is displayed.	✓
Short address	The short address is displayed.	✓
Status	The current status is displayed. <ul style="list-style-type: none"> • Normal (not connected to network) • Normal (connected to network) • Updating firmware • Alarm issued • Radio transmission time exceeded 	✓
Network	The network status is displayed. <ul style="list-style-type: none"> • No network connection • Normal • Isolation • Authentication error • Radio transmission stopped • Sending serial data 	✓
RSSI value	The RSSI value for packet reception is displayed. * The reflection of the RSSI value may take some time depending on the packet reception condition.	✓
Network name	The network name in use is displayed.	
IPv6 address	The IPv6 address is displayed.	
DODAG ID	The DODAG ID in use is displayed.	

4.6.5 Setting the Network Scale (Network scale setup)

Optimize the control signal transmission frequency of the wireless communication module according to the network scale.

How to open this window:

- In the main window, click **Router configuration**. In the router configuration selection window, click **Network scale setup** on the **Tool** menu.

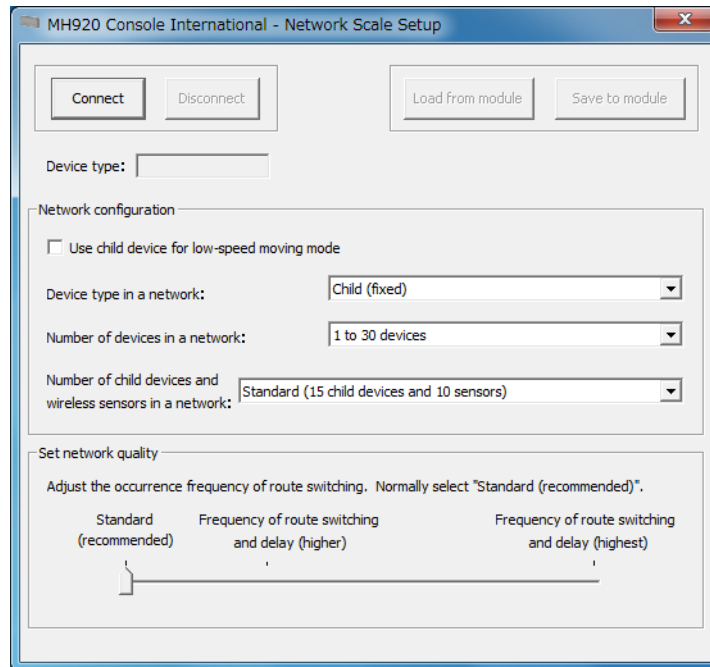

■ **Setting the information**

Click **Connect**, set the following items, and click **Save to module** to apply the set information to the wireless communication module.

Item	Description
Use child device for low-speed moving mode	Do not select this check box.
Device type in a network	Select the type of device in the network from the following: • Child (fixed) • Child (fixed) + wireless sensor
Number of devices in a network	Select the number of devices in the network from the following: • 1 to 30 devices • 31 to 60 devices • 61 to 100 devices
Number of child devices and wireless sensors in a network	Select the number of child devices and wireless sensors in the network. • Child device only (up to 25 child devices) • Standard (15 child devices and 10 sensors) • Maximum number of wireless sensors (5 Child devices and 20 sensors)
Set network quality	Select the network quality from the following: • Standard (recommended) • Frequency of route switching and delay (higher) • Frequency of route switching and delay (highest)

Note

- To apply the settings entered in the Network scale setup window to the wireless communication module, click **Save to module**, and then restart the module by turning the main unit's power off and then back on or by pressing the reboot switch.
- Match the "Device type in a network" and "Number of devices in a network" settings between the coordinator and router.
- Be sure to match the Number of devices in a network to the number of routers with the same PAN ID (group number). In addition, be sure to set the same network scale for routers with the same PAN ID (group number). Otherwise, data omission or router disconnection may occur.
- For wireless communication modules with the Network join mode set to Fast join mode, the Use child device for low-speed moving mode check box is not available.

■ Loading the current settings from the wireless communication module

Click **Connect** and then **Load from module** to load the current settings from the wireless communication module. You can change the network scale based on the loaded information.

4.7 Configuring the Coordinator Module (Low-speed moving body)

This section explains the configuration of a coordinator module when routers are used in a low-speed moving state. When using routers in fixed locations, see section 4.5, "Configuring the Coordinator Module."

4.7.1 Setup Procedure

Configure the coordinator module by following the procedure below.

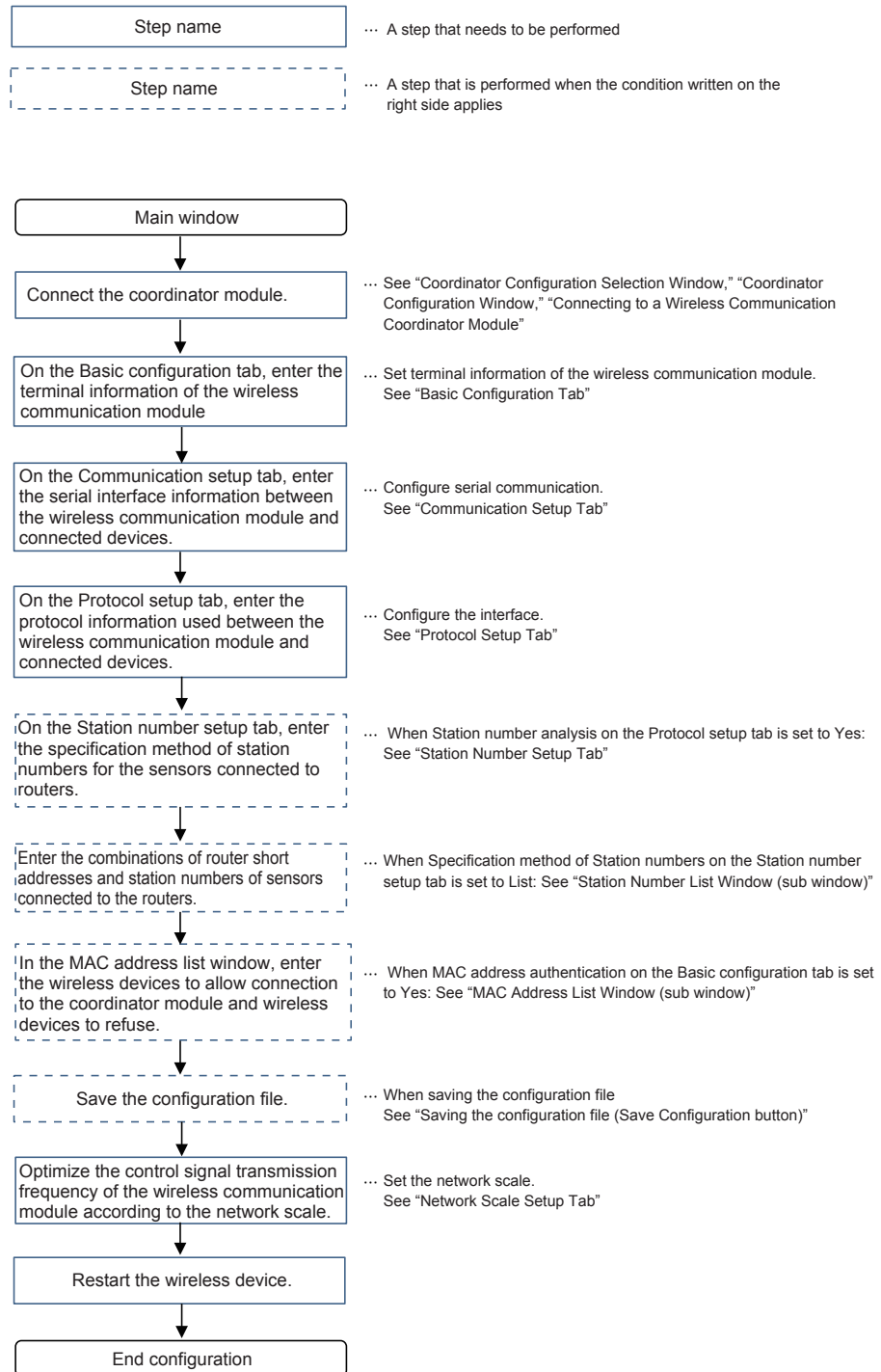

Coordinator configuration selection window

Use the coordinator configuration selection window to display the coordinator module configuration window or display the status.

How to open this window:

- In the main window, click **Coordinator configuration**.

You can also open this window by clicking **Menu** and then **Coordinator configuration** in the router configuration selection window.

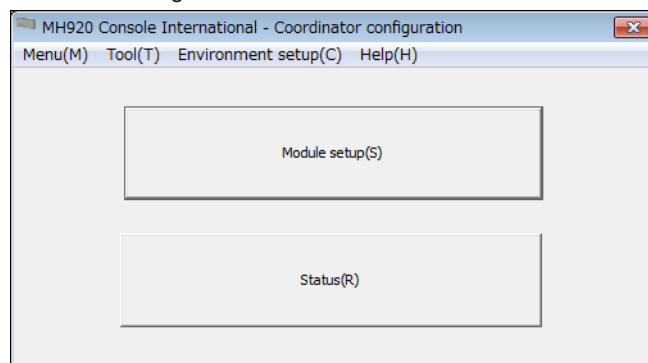

■ Buttons

Item	Description
Module setup	A Coordinator configuration window opens.
Status	A coordinator status window opens.

■ Menu bar

You can use the menu bar to switch to the router configuration selection window, Environment setup window, or main window, update the firmware, and so on.

Item	Description	Description
Menu	Coordinator configuration	This is not available because the window is already open.
	Router set up	A router configuration selection window opens.
	Exit	Closes the coordinator configuration selection window and returns to the main window.
Tool	Display topology	A Display topology window opens.
	Get Log	A Get log window opens.
	Firmware update	A Firmware update window opens.
	Network scale setup	A Network scale setup window opens.
	Cancel radio transmission time display	A cancel radio transmission time display window opens.
	Restore factory preset	Restores the settings of the connected wireless device to their factory defaults.
Environment setup	An Environment setup window opens.	

For details on how to use the various functions (windows) accessible from the Tool menu, see section 4.9, “Other Functions (Tool menu).”

Coordinator Configuration Window

In the Coordinator configuration window, you can configure the wireless communication module and set various terminal information.

How to open this window:

- In the main window, click **Coordinator configuration**. In the coordinator configuration selection window, click **Module setup**.

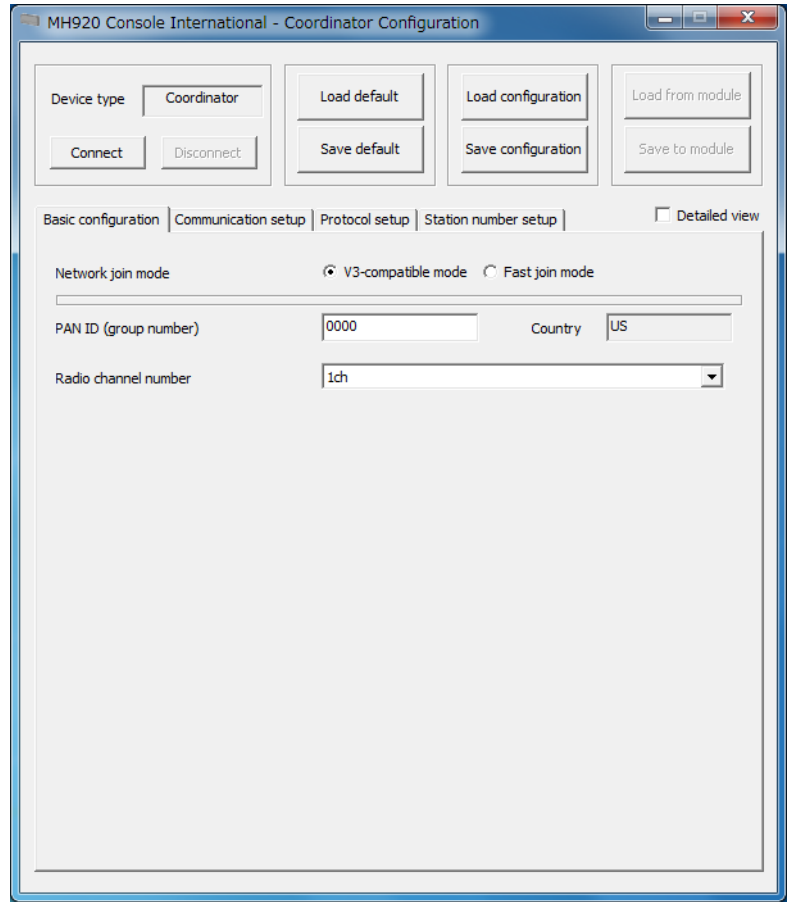

In the top area of the Coordinator configuration window, buttons for connecting and disconnecting the wireless communication module, buttons for loading and saving value set in the wireless communication module, and buttons for loading and saving configuration files are available.

The Coordinator configuration window also has the following configuration tabs. Click the tabs to configure the various settings.

- Basic configuration tab
- Communication setup tab
- Protocol setup tab
- Station number setup tab

Note

- To apply the settings entered on the tabs of the Coordinator configuration window to the wireless communication module, click **Save to module**, and then restart the module by turning the main unit's power off and then back on or by pressing the reboot switch.
- Entering zeros for the MH920 Console International settings causes those settings to be deleted. Be sure to enter non-zero values in all the settings.

■ Saving default values (Save default button)

Click **Save default** after setting the terminal information to save the various values as maintenance console's default values.

The information on each of the Basic configuration, Communication setup, Protocol setup, and Station number setup tabs and the Detailed view check box state are saved here. The default values that are saved can be loaded into the corresponding settings in the maintenance console by clicking **Load default**.

■ Loading default values (Load default button)

Click **Load default** to load the maintenance console's default values and shows them in the corresponding settings.

Load default loads the content of the file containing the maintenance console's default values. This file is automatically loaded when the Coordinator configuration is opened. Save default can be used to save the entered values as the maintenance console's default values. You can load the saved default values, change a portion of the settings, and use them.

■ Saving the configuration file (Save Configuration button)

Click to **Save Configuration** after setting the terminal information to save the information on each of the Basic configuration, Communication setup, Protocol setup, and Station number setup tabs in a configuration file.

The file that is saved using Save Configuration can be loaded into the corresponding settings in the maintenance console by clicking **Load Configuration**.

The configuration file is saved with the specified file name in the specified folder. By default, the file is saved with the following file name in the following folder.

- C:\OKI\MH920 Console International\Setting_Files\CM_MAC address_date and time.csv
- * The MAC address is set to 0000000000000000 if the file is saved without a wireless module connected.

■ Loading the configuration file (Load Configuration button)

Click **Load Configuration** to load a configuration file created in advance and show the content of the file in the Maintenance console window. When a configuration file is loaded, the information on each of the Basic configuration, Communication setup, Protocol setup, and Station number setup tabs is loaded. Do not load a configuration file when using the product for the first time after purchase or after resetting the settings to their factory defaults (be sure to save the settings first before loading them).

For details on the configuration file, see chapter 5, "List of Settings."

■ Closing the Coordinator configuration window

Click × in the upper right to return to the coordinator configuration selection window.

You cannot close the Coordinator configuration window while the wireless communication coordinator module is connected.

Connecting to the Wireless Communication Coordinator Module

When you connect the maintenance console to a wireless communication module, the module information can be displayed in the Coordinator configuration window and apply the settings you set in the Coordinator configuration window to the module.

■ **Connecting to the wireless communication coordinator module (Connect button)**

Click **Connect** in the top area of the Coordinator configuration window to connect to the wireless communication module.

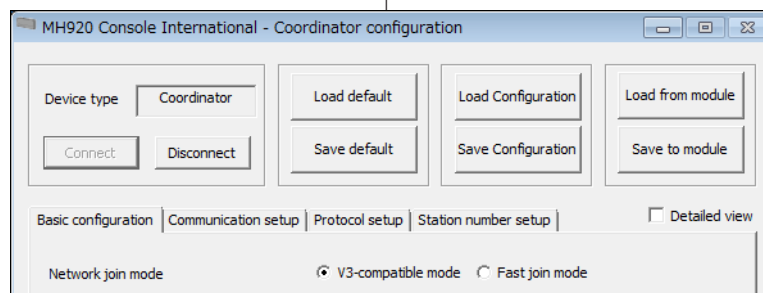
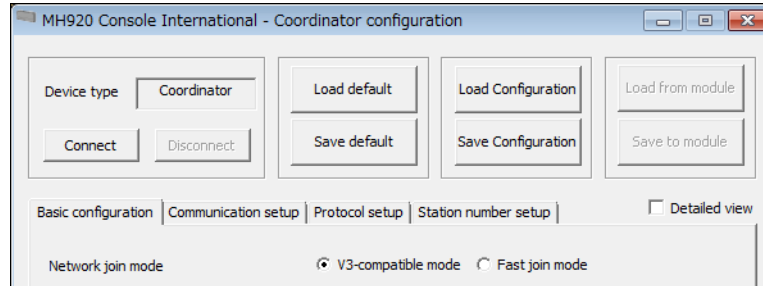

■ **If Omit Password is set to No**

If Omit password is set to No in the Environment setup window, a dialog box for entering the password appears. Enter the password you set in the Environment setup window, and click **Connect**.

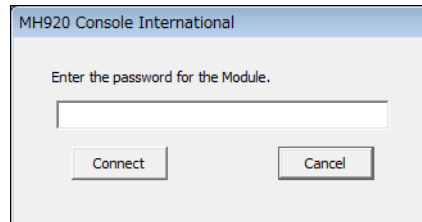

Item	Description
Password	Enter the password. ● The default password is "mh920".

This procedure also applies in other windows when a connection needs to be established with the wireless communication module.

Disconnecting from the Wireless Communication Coordinator Module

Click **Disconnect** in the top area of the Coordinator configuration window to disconnect from the wireless communication module.

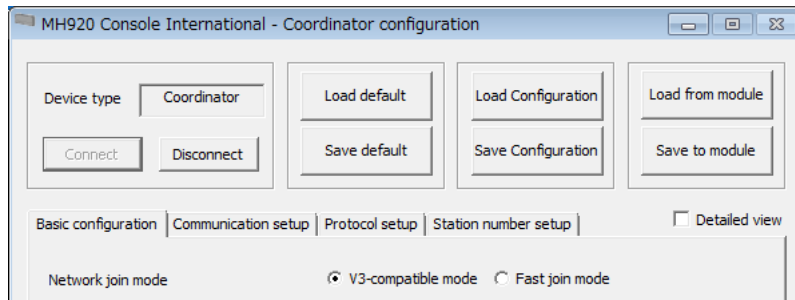

Note

Do not remove the USB cable or cut off the power supply when the maintenance console is connected to a wireless communication module. If you perform these acts while data is being written to the wireless communication module (during firmware updating or configuration), the configuration information may become corrupted.

Setting the Terminal Information of the Wireless Communication Module (Basic configuration tab)

Set terminal information of the wireless communication module.

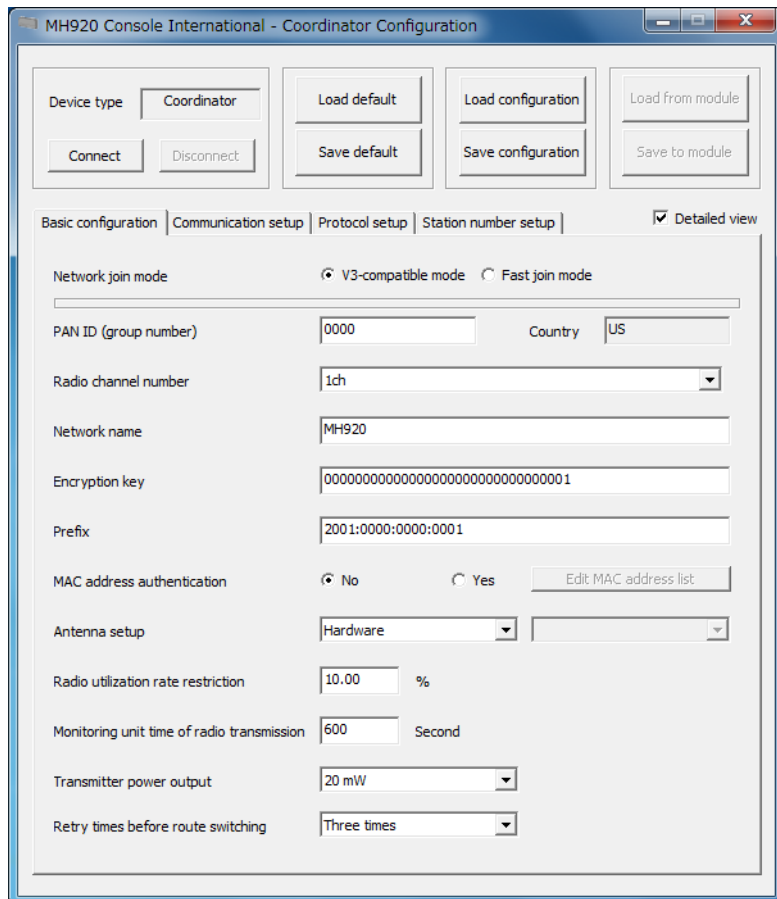

The following figure shows the window with the Detailed view check box selected. If you remove the Detailed view check box, only the items with a check mark in the Simple view column of the next table are displayed.

4.7 Configuring the Coordinator Module (Low-speed moving body)

■ Setting the terminal information

Set the following items. Click **Save to module** to apply the set information to the wireless communication module.

Item	Description	Simple view
Network join mode	Select V3-compatible mode. (*1)	✓
Preferred PAN ID (group number)	Enter the preferred PAN ID (0001 to FFFE) to connect to. • To not specify the preferred PAN ID, enter "0000".	✓
Radio channel number	Select the channel number (1 to 43 ch or 1 to 14 ch).	✓
Network name	Enter using up to 16 alphanumeric characters.	
Encryption key	Enter the network encryption key (hexadecimal: 32 digits).	
Prefix	Enter the higher 64 bits of the IPv6 address. (*2)	
MAC address authentication	Select whether to perform MAC address authentication. • If you select Yes, the allow radio device list and refuse radio device list are enabled.	
Antenna setup	Select Hardware or Software . Hardware is fixed to External antenna. If you select Software, the list on the right is enabled allowing you to select the antenna to use and diversity. In addition, the antenna setup specified on the maintenance console is applied to the measurement tool transmission test. The available settings are as follows: • Internal * • External • Diversity (external + internal) • Diversity (external + external) * Do not select this option.	
Radio utilization rate restriction	0.00 to 99.99 % Default: 10.00 %	
Monitoring Unit Time of Radio Transmission	Enter the monitoring unit time of radio transmission utilization rate (10 to 3600 seconds).	
Transmitter power output	Select the signal level (0.16 mW, 1 mW, 20 mW) for the US radio transmission. Select the signal level (0.16 mW, 1 mW, 5 mW, 12.5mW) for the Korea radio transmission. In addition, the transmitter output specified on the maintenance console is applied to the measurement tool transmission test.	
Retry times before route switching	Set the number of retries (1, 2, 3) before switching the communication route when communication fails from the coordinator to a router.	

*1: Fast join mode cannot be used.

*2: When terminal information is obtained before the first configuration after purchase or after resetting the settings to their factory defaults, be sure to set the prefix.

Note

We recommend you change the network name, PAN-ID, encryption key, and channel number from the default values set in the MH920 Console International.

■ Loading the current settings from the wireless communication module

Click **Load from module** to load the current settings from the wireless communication module. You can change the terminal information based on the loaded information.

Note

- The factory default Network join mode is V3-compatible mode, regardless of the firmware version.
- If you are handling a wireless communication module in the factory default condition, do not perform Load from module using the MH920 Console International. Instead, configure the necessary settings using the MH920 Console International, and perform Save to module. Because there are settings with different default values between the MH920 Console International and the firmware, the module will not operate properly.

Configuring Serial Communication (Communication setup tab)

Configure the serial communication settings between the wireless communication module and devices.

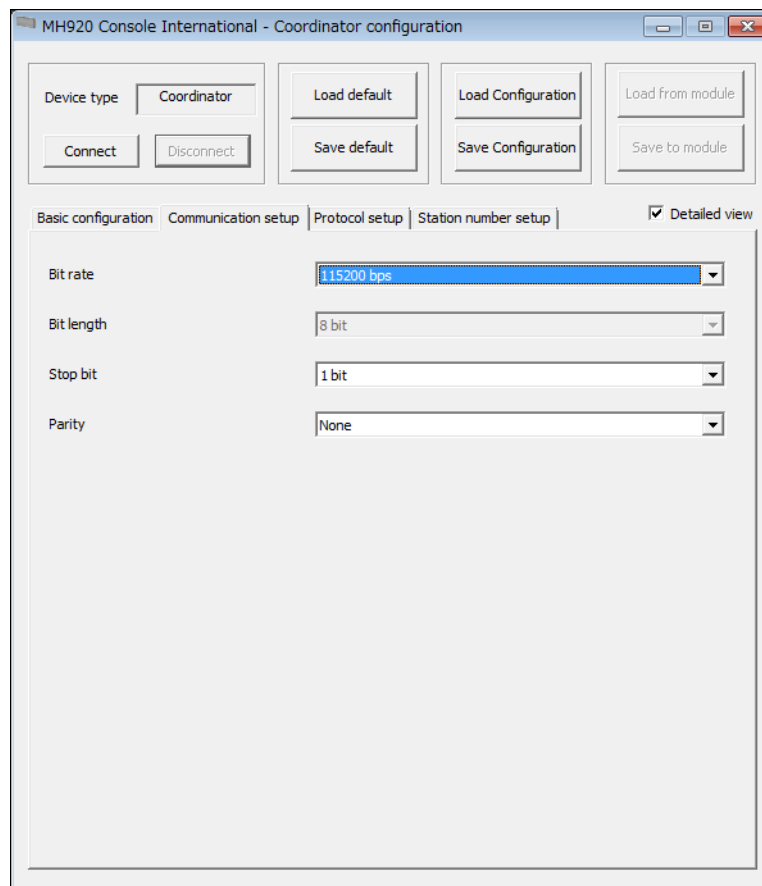

The items on the Communication setup tab are the same regardless of whether the Detailed view check box is selected.

■ Setting the information

Set the following items. Click **Save to module** to apply the set information to the wireless communication module.

Item	Description
Bit rate	Select 115200 bps.
Bit length	The bit length is fixed to 8 bit.
Stop bit	Select the stop bit (1 bit).
Parity	Select the parity (None).

■ Loading the current settings from the wireless communication module

Click **Load from module** to load the current settings from the wireless communication module. You can change the interface information based on the loaded information.

4.7 Configuring the Coordinator Module (Low-speed moving body)

Configuring the Interface (Protocol setup tab)

Set the interface information (protocol) used between the wireless communication module and the connected device.

The screenshot shows the 'MH920 Console International - Coordinator configuration' window with the 'Protocol setup' tab selected. The 'Detailed view' checkbox is checked. The configuration options are as follows:

Category	Option	Value
Station number analysis	<input checked="" type="radio"/> Yes	
Data transmission interval when transmitting to all the child devices		3 ×100 ms
Protocol type		Other(ASCII)
ModBus(RTU)		
Presence of broadcast address	<input checked="" type="radio"/> No	
Other(ASCII)		
Start character code 1	<input checked="" type="radio"/> Yes	25
Start character code 2	<input checked="" type="radio"/> Yes	3C
Condition of start character code	<input checked="" type="radio"/> Or	
Station number start position after start character code		0 bytes
Station number store area		2 bytes
Station number size		2 bytes

The following figure shows the window with the Detailed view check box selected. If you remove the Detailed view check box, only the items with a check mark in the Simple view column of the next table are displayed.

■ Setting the information

Set the following items. Click **Save to module** to apply the set information to the wireless communication module.

Item		Description	Simple view
Station number analysis (*1)		For the coordinator, set Station number analysis to No or Yes. The settings for the station number analysis selected here are enabled.	✓
Data transmission interval when transmitting to all the child devices (*2)		If Station number analysis is set to No, set the interval for transmitting data from the coordinator to each router. The factory default value is 3. (Setting range: 1 to 50 (×100 milliseconds))	
Protocol type		Select the protocol type (Modbus (RTU)). The settings for the protocol type selected here are enabled.	✓
Station number analysis Yes/Modbus (RTU)	Presence of broadcast address	This is enabled only when Protocol type is set to Modbus (RTU). Set whether a broadcast address is available, and if yes, enter the address (decimal: 0 to 255).	

*1: If Station number analysis is set to No, the coordinator sends commands to all routers in the network, excluding dedicated repeaters without connected terminals and waits for the responses from relevant routers. With this method, there is no need to associate the short address station numbers of routers. In this case, because commands are sent to all routers, it will take time for a response to be returned to the host device. For dedicated repeaters without connected terminals, set Equipment Connection to No on the Communication setup tab of the router to prevent data transmission.

*2: If the size of the data to be transmitted is large, the transmission interval may be longer than the specified transmission interval time. In addition, if the transmission frequency is increased, the 10% duty transmission time limit may be exceeded.

Item		Description	Simple view
Station number analysis Yes/No/Modbus (RTU)	Packet filtering (*1)	Set the packet filtering function to None, Yes (notification type), or Yes (polling type). If set to Yes (polling type), delayed packets and the like are discarded according to filter timeout value. If set to Yes (notification type), delayed packets that are not from polling and the like are discarded.	
	Filter timeout on polling	Set the value to 1 second less than retransmission time of the host device (e.g., data acquisition device). Filtering is performed using the timeout value calculated in the device. Be sure to set a value no less than 1 second. The factory default value is 40. (Setting range: 10 to 600 (×100 milliseconds))	

*1: Set the packet filtering to the same value (No, Yes (notification type), or Yes (polling type)) for all wireless devices in the same network.

■ Loading the current settings from the wireless communication module

Click **Load from module** to load the current settings from the wireless communication module. You can change the protocol setup based on the loaded information.

Station number setup tab

Set the specification method of station numbers for devices connecting to routers.

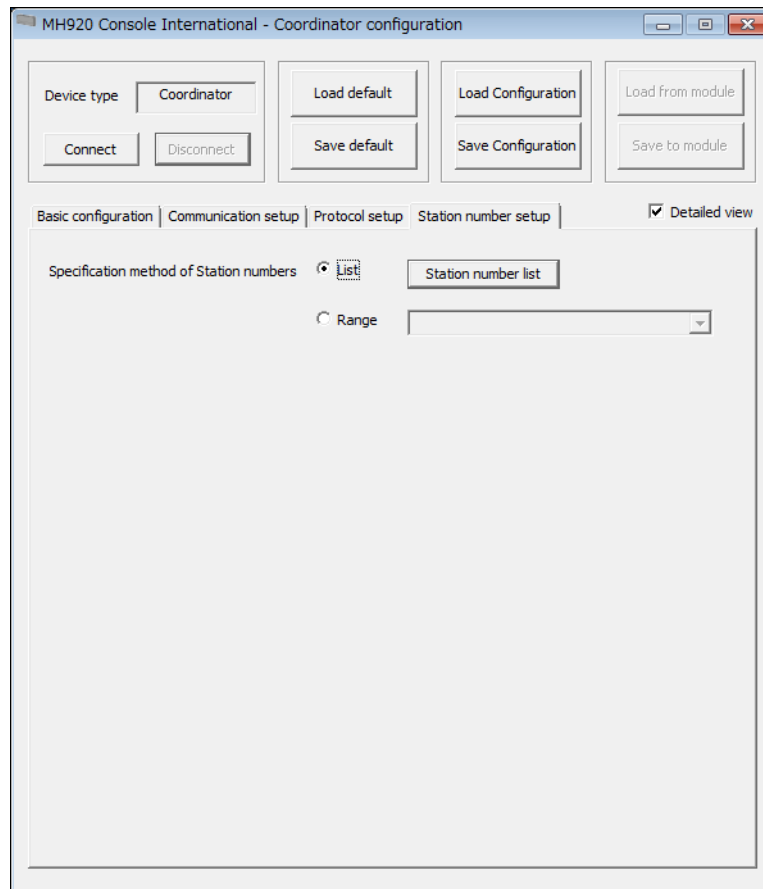

The items on the Station number setup tab are the same regardless of whether the Detailed view check box is selected.

■ Setting the terminal information

Set the following items. Click **Save to module** to apply the set information to the wireless communication module.

Item	Description
Specification method of Station numbers	<p>Select the specification method of Station numbers (List, Range). (*)</p> <ul style="list-style-type: none"> If you select List, click Station number list to open a Station number list window, and set the station number list. In the Station number list window, register combinations of routers' short addresses and station numbers of devices connected to the routers. If you select Range, select the maximum number of multidrops (1/1 to 4/1 to 8/1 to 16/1 to 31).

*: To use no station number analysis mode, set **Station number analysis** to No on the Protocol setup tab.

■ Loading the current settings from the wireless communication module

Click **Load from module** to load the current settings from the wireless communication module. You can change the terminal information based on the loaded information.

4.7.2 MAC Address List Window (sub window)

In the MAC address list window, you can set wireless devices to allow connection to the wireless communication coordinator module and wireless devices to refuse.

How to open this window:

- In the main window, click **Coordinator configuration**. In the coordinator configuration selection window, click **Module setup**. In the Coordinator configuration window, click the **Basic configuration** tab and then **Edit MAC address list**.

You can enable the **Edit MAC address list** button by setting **MAC address authentication** to Yes on the Basic configuration tab of the Coordinator configuration window. Click **Edit MAC address list** to open a MAC address list window where you can set the allow radio device list and refuse radio device list.

The MAC address list window contains the following two tabs:

- Allow radio device list tab
- Refuse radio device list tab

Allow radio device list tab

In the wireless communication coordinator module, set the MAC addresses and the encryption key for encrypted communication for routers that you want to allow joining the wireless network. You can also load settings from the wireless communication module and save the settings you enter here in a configuration file.

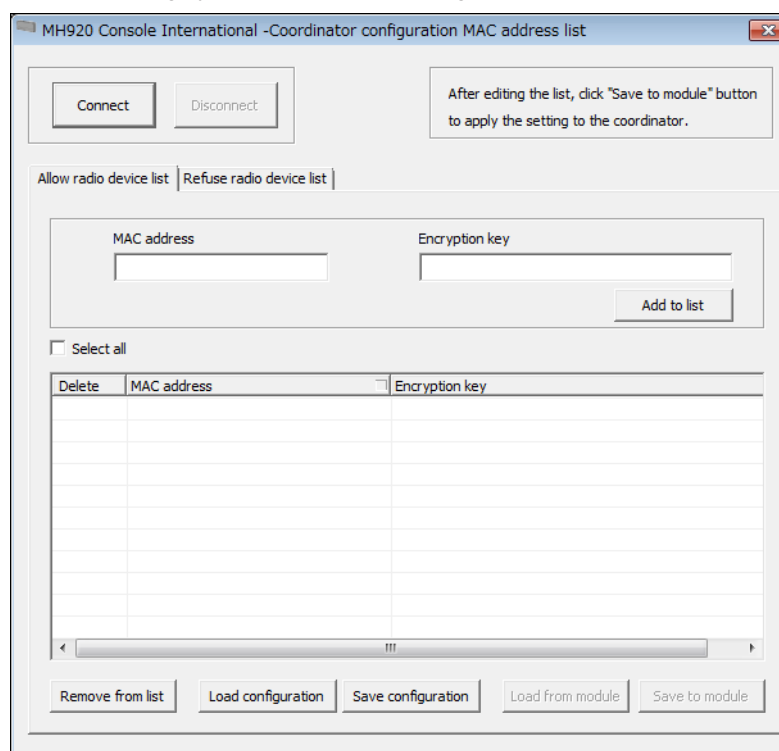

4.7 Configuring the Coordinator Module (Low-speed moving body)

■ To set the allow radio device list

Enter the following items to create the allow radio device list. Click **Save to module** to apply the allow radio device list to the wireless communication module.

Item	Description
MAC address	Enter the MAC address (64 bits) of the router you want to add to the allow radio device list. Click Add to list to add the address along with the information entered in the Encryption key box to the list.
Encryption key	Enter the encryption key (hexadecimal: 32 digits) of the router you want to add to the allow radio device list. Click Add to list to add the key along with the information entered in the MAC address box to the list.

■ To delete information from the allow radio device list

Enter a check mark in the Delete column of the entry you want to delete, and click **Remove** from list. The selected entry is deleted from the list. Click **Save to module** to apply the allow radio device list to the wireless communication module.

Select the **Select all** check box to enter check marks in the Delete column of all entries.

■ Loading the current settings from the wireless communication module

Click **Load from module** to load the current settings from the wireless communication module. You can change the allow radio device list based on the loaded information.

■ To save the allow radio device list

After setting the allow radio device list, click **Save configuration**. The allow radio device list (MAC addresses and encryption keys) is saved with the specified file name in the specified folder. By default, the file is saved with the following file name in the following folder.

- C:\OKI\MH920 Console International\Node_Log\MAC address _MacList_date and time.csv
- * The MAC address is omitted if the file is saved without a wireless module connected.

■ To Load the allow radio device list from a configuration file

Click **Load Configuration** to load a configuration file containing the allow radio device list (MAC addresses and encryption keys) and show the content of the file in the Maintenance console window.

Refuse radio device list tab

In the wireless communication coordinator module, set MAC addresses of routers that you want to prevent from joining the wireless network.

■ To set the refuse radio device list

Enter the following items to create the refuse radio device list. Click **Save to module** to apply the refuse radio device list to the wireless communication module.

Item	Description
MAC address	Enter the MAC address (64 bits) of the router you want to add to the refuse radio device list. Click Add to list to add the entry to the list.

■ To delete information from the refuse radio device list

Enter a check mark in the Delete column of the entry you want to delete, and click **Remove from list**. The selected entry is deleted from the list. Click **Save to module** to apply the refuse radio device list to the wireless communication module.

Select the **Select all** check box to enter check marks in the Delete column of all entries.

4.7 Configuring the Coordinator Module (Low-speed moving body)

Note

- The addition and deletion of wireless communication modules to refuse the connection of are applied immediately without the restarting of the coordinator module. However, if MAC address authentication is registered for the first time, you must restart the coordinator module.
- If you want to refuse the connection of a wireless communication module that is already connected, add the module to the wireless device list and then disconnect the applicable wireless communication module such as by restarting the wireless communication coordinator module.

■ Loading the current settings from the wireless communication module

Click **Load from module** to load the current settings from the wireless communication module. You can change the refuse radio device list based on the loaded information.

■ To save the refuse radio device list

After setting the refuse radio device list, click **Save configuration**. The refuse radio device list is saved with the specified file name in the specified folder. By default, the file is saved with the following file name in the following folder.

- C:\OKI\MH920 Console International\Node_Log\MAC address_BlackList_date and time.csv

* The MAC address is omitted if the file is saved without a wireless module connected.

■ To Load the refuse radio device list from a configuration file

Click **Load Configuration** to load a configuration file containing the refuse radio device list and show the content of the file in the Maintenance console window.

4.7.3 Station Number List Window (sub window)

In the Station number list window, register combinations of routers' short addresses and station numbers of devices connected to the routers.

How to open this window:

- In the main window, click **Coordinator configuration**. In the coordinator configuration selection window, click **Module setup**. In the Coordinator configuration window, click the **Station number setup** tab and then **Station number list**.

You can enable the **Station number list** button by setting the **Specification method of Station numbers** to List on the Station number setup tab of the Coordinator configuration window. Click **Station number list** to open a Station number list window.

■ To register a station number list

Enter the following items to create the station number list. Click **Save to module** to apply the contents of the station number list to the wireless communication module.

Item	Description
Short address	Enter the short address (0001 to FFFD) of the router you want to add to the list. Click Add to list to add the address along with the information entered in the Station number box to the list.
Station number	Enter the station number corresponding to the router's short address. Click Add to list to add the station number along with the information entered in the Short address box to the list.

Note

If you register the station number list when there is no list in the MH920 Console International or when a station number list has not been loaded from the wireless communication module, the station number list registered in the wireless communication module will be deleted.

4.7 Configuring the Coordinator Module (Low-speed moving body)

■ To delete information from the station number list

Enter a check mark in the Delete column of the entry you want to delete, and click **Remove** from list. The selected entry is deleted from the list. Click **Save to module** to apply the contents of the station number list to the wireless communication module.

■ Loading the current settings from the wireless communication module

Click **Load from module** to load the current settings from the wireless communication module. You can change the station number list based on the loaded information.

Note //

Before loading the current settings from the wireless communication module, perform either of the procedures below.

- Connect a wireless communication module with updated configuration, and then load the settings by using **Load from module** in the Coordinator configuration window. For details, see “Loading the current settings from the wireless communication module” in “Configuring the Interface (Protocol setup tab)”.
 - Load the setting from a configuration file saved in advance by using **Load Configuration** in the Coordinator configuration window. For details, “Loading the configuration file (Load Configuration button)” in the Coordinator configuration window.
- //

■ To save the station number list you edited

After setting the station number list, click **Save configuration**. The station number list is saved with the specified file name in the specified folder. By default, the file is saved with the following file name in the following folder.

- C:\OKI\MH920 Console International\Node_Log\MAC address_p3_NumList_date and time.csv

* The MAC address is omitted if the file is saved without a wireless module connected.

■ To Load the station number list from a configuration file

Click **Load Configuration** to load a configuration file containing the station number list and show the content of the file in the Maintenance console window.

Note //

Before loading the station number list from a con, perform either of the procedures below.

- Connect a wireless communication module with updated configuration, and then load the settings by using **Load from module** in the Coordinator configuration window. For details, see “Loading the current settings from the wireless communication module” in “Configuring the Interface (Protocol setup tab)”.
 - Load the setting from a configuration file saved in advance by using **Load Configuration** in the Coordinator configuration window. For details, “Loading the configuration file (Load Configuration button)” in the Coordinator configuration window.
- //

4.7.4 Status Window

The status window shows the wireless communication coordinator module information.

How to open this window:

- In the main window, click **Coordinator configuration**. In the coordinator configuration selection window, click **Status**.

Clicking Status automatically establishes a connection with the wireless communication module and shows a message indicating that status information will be loaded from the wireless communication module.

Click **Yes** to open a Status window.

If a password prompt window appears, see “If Omit Password is set to No” in section 4.5.3, “Coordinator Configuration Window.”

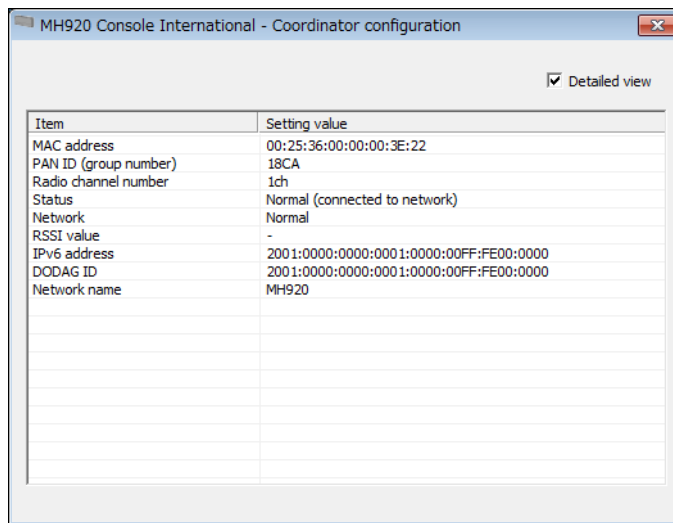

4.7 Configuring the Coordinator Module (Low-speed moving body)

The following figure shows the window with the Detailed view check box selected. If you remove the Detailed view check box, only the items with a check mark in the Simple view column of the next table are displayed.

Item	Description	Simple view
MAC address	The 64 bit MAC address is displayed.	✓
PAN ID (group number)	The PAN ID in use is displayed.	✓
Radio channel number	The channel number in use is displayed.	✓
Status	The current status is displayed. <ul style="list-style-type: none">• Normal (not connected to network)• Normal (connected to network)• Updating firmware• Alarm issued• Radio transmission time exceeded	✓
Network	The network status is displayed. <ul style="list-style-type: none">• No network connection• Normal• Authentication error• Radio transmission stopped• Sending serial data	✓
RSSI value	—	✓
IPv6 address	The IPv6 address assigned to the wireless module is displayed.	
DODAG ID	The DODAG ID in use is displayed.	
Network name	The network name in use is displayed.	

4.7.5 Setting the Network Scale (Network scale setup)

Optimize the control signal transmission frequency of the wireless communication module according to the network scale.

How to open this window:

- In the main window, click **Coordinator configuration**. In the coordinator configuration selection window, click **Network scale setup** on the **Tool** menu.

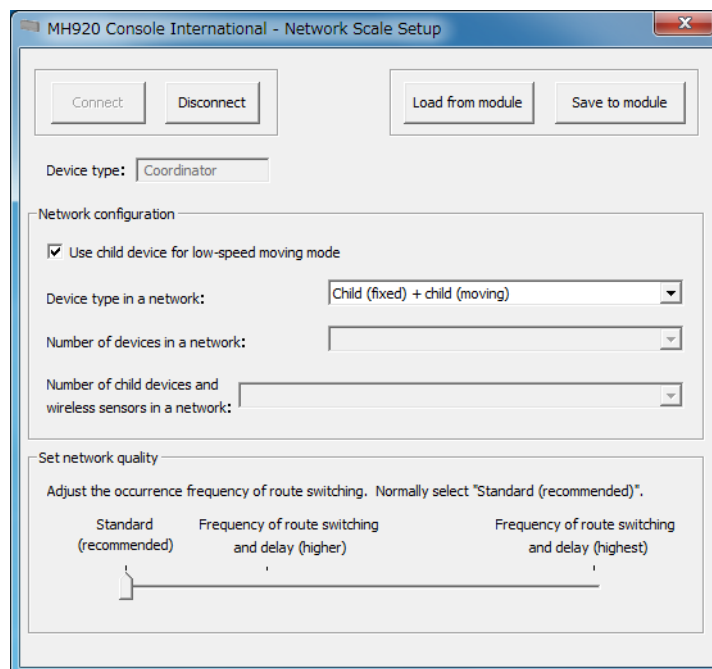

■ Setting the information

Click **Connect**, set the following items, and click **Save to module** to apply the set information to the wireless communication module.

Item	Description
Use child device for low-speed moving mode	Select the check box to use low-speed moving mode.
Device type in a network	Select the type of device in the network from the following: <ul style="list-style-type: none"> • Child (fixed) + child (Moving)
Number of devices in a network	You cannot select this.
Number of child devices and wireless sensors in a network	You cannot select this.
Set network quality	Select the network quality from the following: <ul style="list-style-type: none"> • Standard (recommended) • Frequency of route switching and delay (higher) • Frequency of route switching and delay (highest)

4.7 Configuring the Coordinator Module (Low-speed moving body)

Note

- To apply the settings entered in the Network scale setup window to the wireless communication module, click **Save to module**, and then restart the module by turning the power off and then back on.
- Be sure to match the “Number of devices in a network” to the number of routers with the same PAN ID (group number). In addition, be sure to set the same network scale for routers with the same PAN ID (group number). Otherwise, data omission or router disconnection may occur.
- For wireless communication modules with the Network join mode set to Fast join mode, the Use child device for low-speed moving mode check box is not available.

■ **Loading the current settings from the wireless communication module**

Click **Connect** and then **Load from module** to load the current settings from the wireless communication module. You can change the network scale based on the loaded information.

4.8 Configuring the Router Module (Low-speed moving body)

This section explains the configuration of a router module when routers are used in a low-speed moving state. When using routers in fixed locations, see section 4.6, "Configuring the Router Module."

4.8.1 Setup Procedure

Configure the router module by following the procedure below.

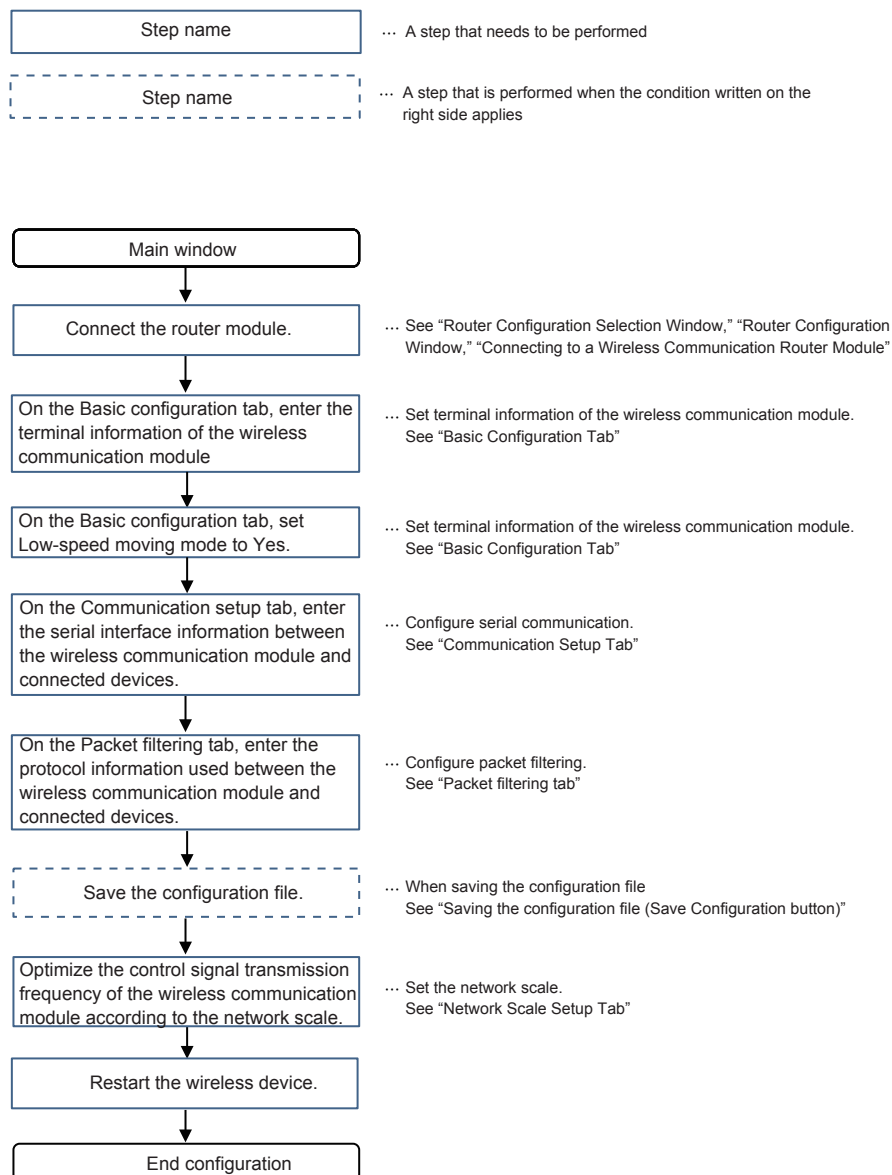

4.8.2 Router configuration selection window

Use the router configuration selection window to display the wireless communication router module configuration window or display the status.

How to open this window:

In the main window, click **Router configuration**.

You can also open this window by clicking **Menu** and then **Router configuration** in the router configuration selection window.

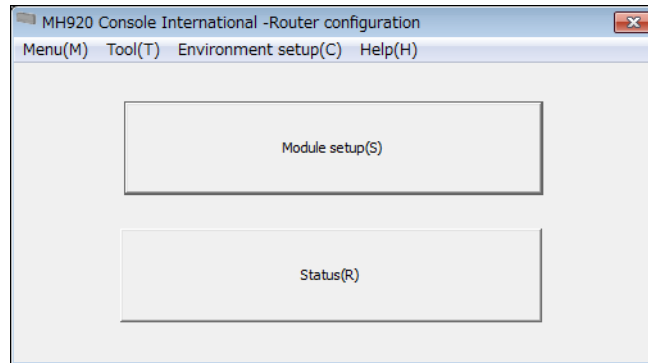

■ **Buttons**

Item	Description
Module setup	A Router configuration window opens.
Status	A router status window opens.

■ **Menu bar**

You can use the menu bar to switch to the Coordinator configuration window, Environment setup window, or main window, update the firmware, and so on.

	Item	Description
Menu	Coordinator configuration	A coordinator configuration selection window opens.
	Router set up	This is not available because the window is already open.
	Exit	Closes the router configuration selection window and returns to the main window.
Tool	Get Log	A Get log window opens.
	Firmware update	A Firmware update window opens.
	Network scale setup	A Network scale setup window opens.
	Cancel radio transmission time display	A cancel radio transmission time display window opens.
	Restore factory preset	Restores the settings of the connected wireless device to their factory defaults.
Environment setup		An Environment setup window opens.

For details on how to use the various functions (windows) accessible from the Tool menu, see section 4.9, “Other Functions (Tool menu).”

4.8.3 Router Configuration Window

In the Router configuration window, you can configure the wireless communication module and set various types of information.

How to open this window:

- In the main window, click **Router configuration**. In the router configuration selection window, click the **Module setup** menu.

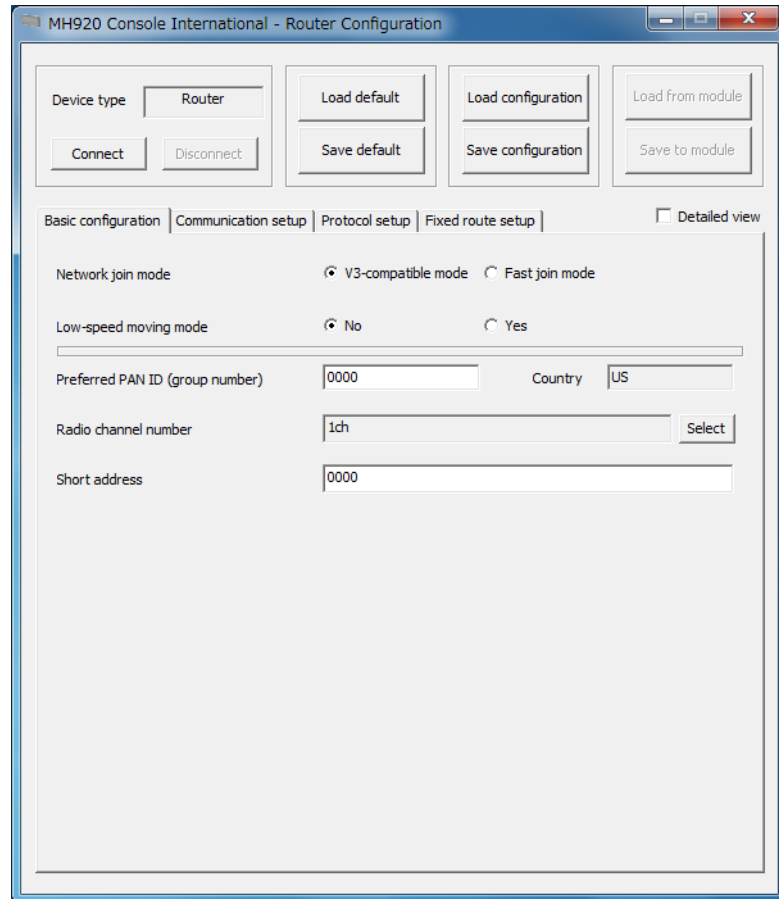

In the top area of the Router configuration window, buttons for connecting and disconnecting the wireless communication router module, buttons for loading and saving value set in the wireless communication router module, and buttons for loading and saving configuration files are available.

The Router configuration window also has the following configuration tabs. Click the tabs to configure the various settings.

- Basic configuration tab
- Communication setup tab
- Packet filtering tab

4.8 Configuring the Router Module (Low-speed moving body)

Note

- * To apply the settings entered on the tabs of the Router configuration window to the wireless communication router module, click **Save to module**, and then restart the module by turning the power off and then back on.
- Entering zeros for the MH920 Console International settings causes those settings to be deleted. Be sure to enter non-zero values in all the settings.
- When a wireless communication router module is used in low-speed moving mode, the fixed route setting is not applied.

■ Saving default values (Save default button)

Click **Save default** after setting the terminal information to save the various values as maintenance console's default values.

The information on each of the Basic configuration, Communication setup, Packet filtering, and Station number setup tabs and the Detailed view check box state are saved here. The default values that are saved can be loaded into the corresponding settings in the maintenance console by clicking **Load default**.

■ Loading default values (Load default button)

Click **Load default** to load the maintenance console's default values and shows them in the corresponding settings.

Load default loads the content of the file containing the maintenance console's default values. This file is automatically loaded when the Router configuration is opened. Save default can be used to save the entered values as the maintenance console's default values. You can load the saved default values, change a portion of the settings, and use them.

■ Saving the configuration file (Save Configuration button)

Click to **Save Configuration** after setting the terminal information to save the information on each of the Basic configuration, Communication setup, Packet filtering, and Fixed route setup tabs in a configuration file.

The file that is saved using Save Configuration can be loaded into the corresponding settings in the maintenance console by clicking **Load Configuration**.

The configuration file is saved with the specified file name in the specified folder. By default, the file is saved with the following file name in the following folder.

- C:\OKI\MH920 Console International\Setting_Files\RM_MAC address_date and time.csv
- * The MAC address is set to 0000000000000000 if the file is saved without a wireless communication module connected.

■ Loading the configuration file (Load Configuration button)

Click **Load Configuration** to load a configuration file created in advance and show the content of the file in the Maintenance console window. When a configuration file is loaded, the information on each of the Basic configuration, Communication setup, Packet filtering, and Fixed route setup tabs is loaded.

For details on the configuration file, see chapter 5, "List of Settings."

■ Closing the Router configuration window

Click × in the upper right to return to the router configuration selection window.

You cannot close the Router configuration window while the wireless communication router module is connected.

Connecting to a Wireless Communication Router Module (Connect button)

When you connect the maintenance console to a wireless communication module, the module information can be displayed in the Router configuration window and apply the settings you set in the Router configuration window to the module.

To connect to a wireless communication router module (Connect button)

Click **Connect** in the top area of the Router configuration window to connect to the wireless communication module.

If Low-speed moving mode is set to Yes, Device type is set to Router (moving).

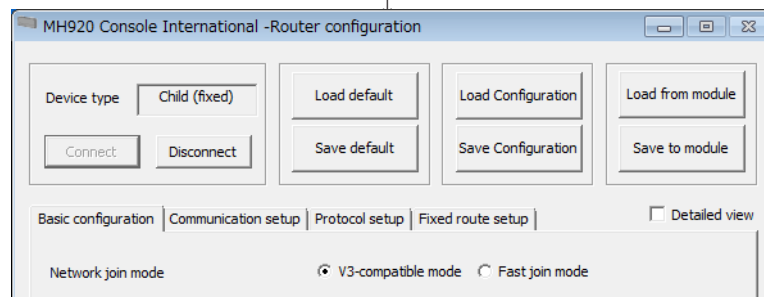
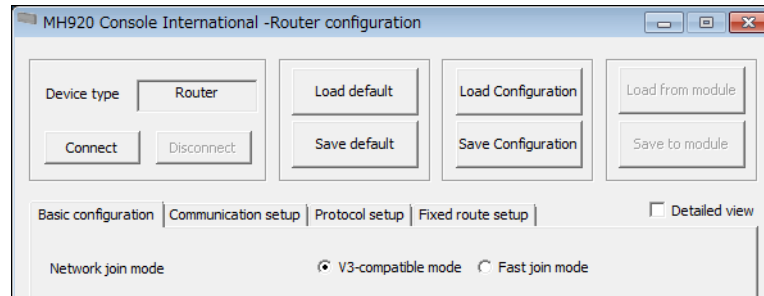

■ If Omit Password is set to No

If Omit password is set to No in the Environment setup window, a dialog box for entering the password appears. Enter the password you set in the Environment setup window, and click **Connect**.

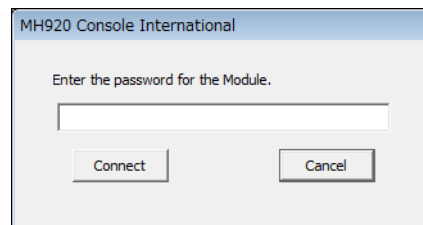

Item	Description
Password	Enter the password. <ul style="list-style-type: none"> The default password is "mh920".

This procedure also applies in other windows when a connection needs to be established with the wireless communication module.

4.8 Configuring the Router Module (Low-speed moving body)

Disconnecting from a Wireless Communication Router Module (Disconnect button)

Click **Disconnect** in the top area of the Router configuration window to disconnect from the wireless communication module.

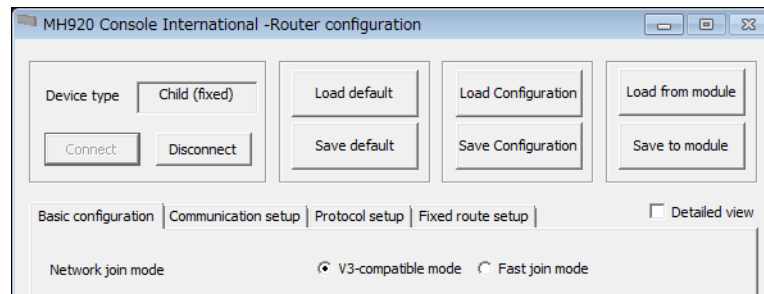

Note

Do not remove the USB cable or cut off the power supply when the maintenance console is connected to a wireless communication module. If you perform these acts while data is being written to the wireless communication module (during firmware updating or configuration), the configuration information may become corrupted.

Setting the Terminal Information of the Wireless Communication Module (Basic configuration tab)

Set terminal information of the wireless communication module.

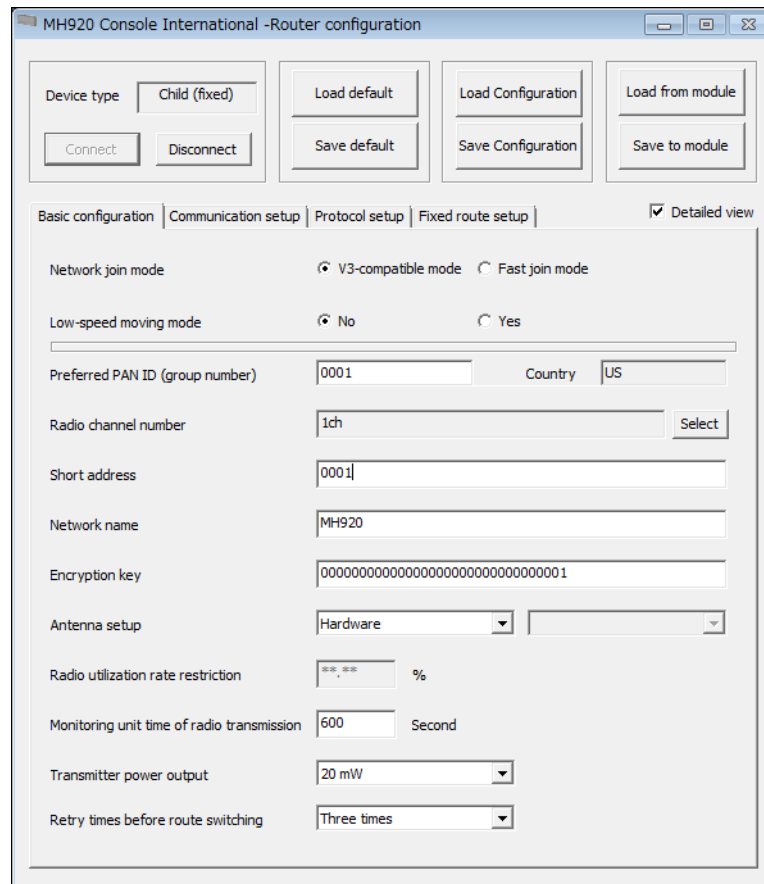

The following figure shows the window with the Detailed view check box selected. If you remove the Detailed view check box, only the items with a check mark in the Simple view column of the next table are displayed.

■ Setting the terminal information

Set the following items. Click **Save to module** to apply the set information to the wireless communication module.

Item	Description	Simple view
Network join mode	Select V3-compatible mode. (*1)	✓
Low-speed moving mode	Select Yes .	✓
Preferred PAN ID to connect to (group number)	Enter the preferred PAN ID (0000 to FFFE) to connect to. • To not specify the preferred PAN ID, enter "0000".	✓
Radio channel number	Select the channel number (1 to 43 ch or 1 to 14 ch). • Up to 10 channels can be selected.	✓
Short address	Enter a different short address (0001 to FFFD) for each router module. • Select a short address that does not overlap with the short addresses of the wireless sensors. • For router modules, do not set the address to 0000.	✓
Network name	Enter using up to 16 alphanumeric characters.	
Encryption key	Enter the network encryption key (hexadecimal: 32 digits).	
Antenna setup	Select Hardware or Software . Hardware is fixed to External antenna. If you select Software, the list on the right is enabled allowing you to select the antenna to use and diversity. In addition, the antenna setup specified on the maintenance console is applied to the measurement tool transmission test. The available settings are as follows: • Internal * • External • Diversity (external + internal) • Diversity (external + external) * Do not select this option.	
Radio utilization rate restriction	0.00 to 99.99 % Default: 10.00 %	
Monitoring Unit Time of Radio Transmission	Enter the monitoring unit time of radio transmission utilization rate (10 to 3600 seconds).	
Transmitter power output	Select the signal level (0.16 mW, 1 mW, 20 mW) for the US radio transmission. Select the signal level (0.16 mW, 1 mW, 5 mW, 12.5mW) for the Korea radio transmission. In addition, the transmitter output specified on the maintenance console is applied to the measurement tool transmission test.	
Retry times before route switching	Set the number of retries (1, 2, 3) before switching the communication route when communication fails from the coordinator to a router.	

*1: Fast join mode cannot be used.

Note

We recommend you change the network name, PAN-ID, encryption key, and channel number from the default values set in the MH920 Console International.

■ Loading the current settings from the wireless communication module

Click **Load from module** to load the current settings from the wireless communication module. You can change the terminal information based on the loaded information.

Note

- The factory default Network join mode is V3-compatible mode, regardless of the firmware version.

4.8 Configuring the Router Module (Low-speed moving body)

Configuring Serial Communication (Communication setup tab)

Configure the serial communication settings between the wireless communication module and devices.

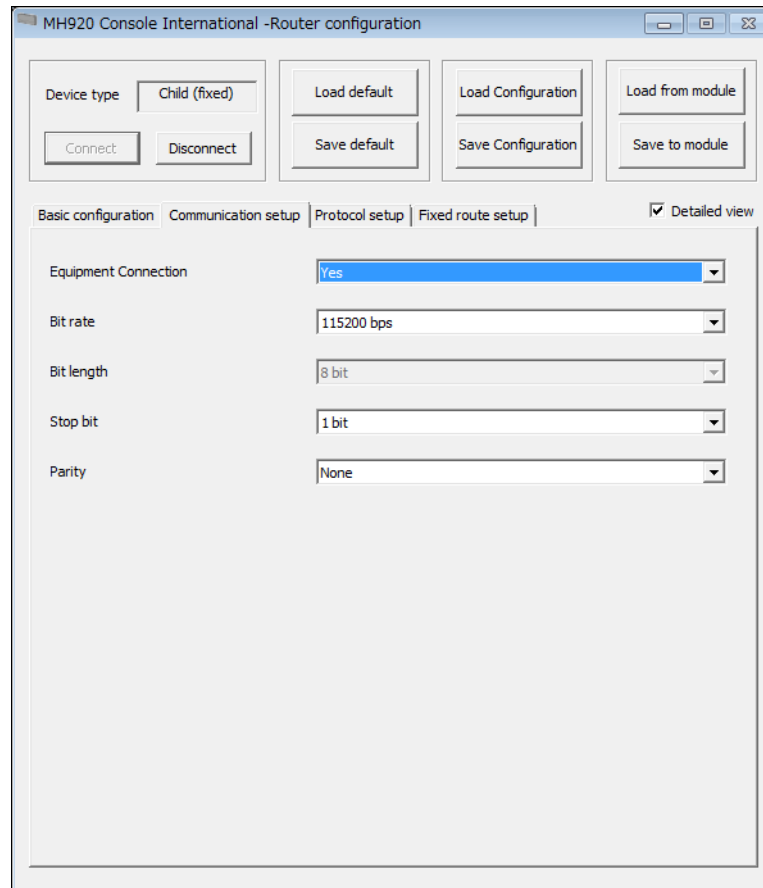

The items on the Communication setup tab are the same regardless of whether the Detailed view check box is selected.

■ Setting the information

Set the following items. Click **Save to module** to apply the set information to the wireless communication module.

Item	Description
Equipment Connection	Select whether there are connections to devices. To use the module only as a repeater, set Equipment Connection to No.
Bit rate	Select 115200 bps.
Bit length	The bit length is fixed to 8 bit.
Stop bit	Select the stop bit (1 bit).
Parity	Select the parity (None).

■ Loading the current settings from the wireless communication module

Click **Load from module** to load the current settings from the wireless communication module. You can change the interface information based on the loaded information.

Configuring Packet Filtering (Packet filtering tab)

Configure the packet filtering settings to use between the wireless communication module and devices. Packet filtering filters unneeded data received from devices. If responses from devices take longer than the specified timeout value, the data is discarded.

The screenshot shows the 'MH920 Console International - Router configuration' window. At the top, there are buttons for 'Device type' (Child (fixed)), 'Connect', 'Disconnect', 'Load default', 'Save default', 'Load Configuration', 'Save Configuration', 'Load from module', and 'Save to module'. Below these are tabs for 'Basic configuration', 'Communication setup', 'Protocol setup', and 'Fixed route setup'. The 'Communication setup' tab is active, and the 'Detailed view' checkbox is checked. The settings shown are: 'Add sender identification' with 'No' selected; 'Packet filtering' with 'Yes (notification type)' selected; and 'Filter timeout on polling' set to '10' with a multiplier of 'x100 ms' and an 'Update' button.

The following figure shows the window with the Detailed view check box selected. If you remove the Detailed view check box, only the items with a check mark in the Simple view column of the next table are displayed.

■ Setting the information

Set the following items. Click **Save to module** to apply the set information to the wireless communication module.

Item	Description	Simple view
Packet filtering	Set the packet filtering function to None, Yes (notification type), or Yes (polling type). If set to Yes (polling type), delayed packets and the like are discarded according to filter timeouts that occur during polling (coordinator to router to coordinator). If set to Yes (notification type), delayed packets and the like in the data transmission in one direction (coordinator to router or router to coordinator) are discarded.	
Filter timeout on polling (*)	Set a value that is greater than or equal to the response time from the wireless communication module to the connected devices (setting range: 0, 10 to 600 (× 100 milliseconds)). If responses from devices take longer than the specified filter timeout on polling, the data is discarded. The factory default value is 10.	

*: If you want to set Packet filtering to Yes (polling type) in no station number analysis mode, set Filter timeout on polling to 0.

4.8 Configuring the Router Module (Low-speed moving body)

■ Loading the current settings from the wireless communication module

Click **Load from module** to load the current settings from the wireless communication module. You can change the packet filtering settings based on the loaded information.

4.8.4 Status Window

The status window shows the wireless communication router module information. Before showing this window, connect to the wireless communication router module.

How to open this window:

- In the main window, click **Router configuration**. In the router configuration selection window, click **Status**.

Clicking **Router configuration** in the main window and clicking **Status** in the router configuration selection window shows a message indicating that status information will be loaded from the wireless communication module. Click **Yes** to open a Status window.

If a password prompt window appears, see “If Omit Password is set to No” in section 4.5.3, “Coordinator Configuration Window.”

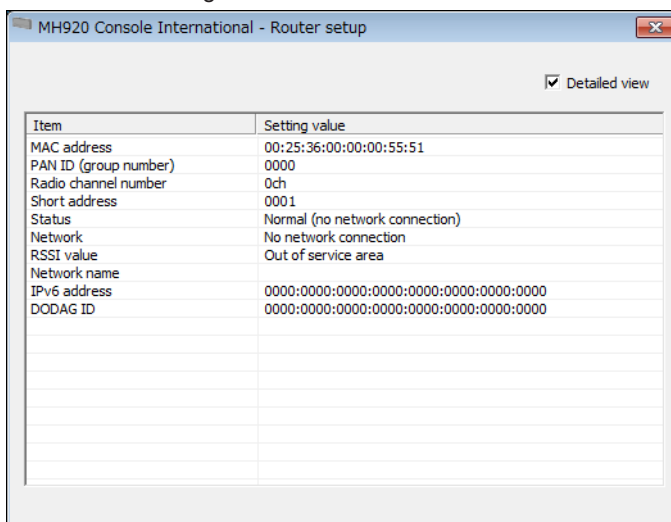

The following figure shows the window with the Detailed view check box selected.

4.8 Configuring the Router Module (Low-speed moving body)

If you remove the Detailed view check box, only the items with a check mark in the Simple view column of the next table are displayed.

Item	Description	Simple view
MAC address	A 64 bit MAC address is displayed.	✓
PAN ID (group number)	The PAN ID in use is displayed.	✓
Radio channel number	The channel number in use is displayed.	✓
Short address	The short address is displayed.	✓
Status	The current status is displayed. <ul style="list-style-type: none"> • Normal (not connected to network) • Normal (connected to network) • Updating firmware • Alarm issued • Radio transmission time exceeded 	✓
Network	The network status is displayed. <ul style="list-style-type: none"> • No network connection • Normal • Isolation • Authentication error • Ra • Sending serial data 	✓
RSSI value	The RSSI value for packet reception is displayed. * The reflection of the RSSI value may take some time depending on the packet reception condition.	✓
Network name	The network name in use is displayed.	
IPv6 address	The IPv6 address is displayed.	
DODAG ID	The DODAG ID in use is displayed.	

4.8.5 Setting the Network Scale (Network scale setup)

Optimize the control signal transmission frequency of the wireless communication module according to the network scale.

How to open this window:

- In the main window, click **Router configuration**. In the router configuration selection window, click **Network scale setup** on the **Tool** menu.

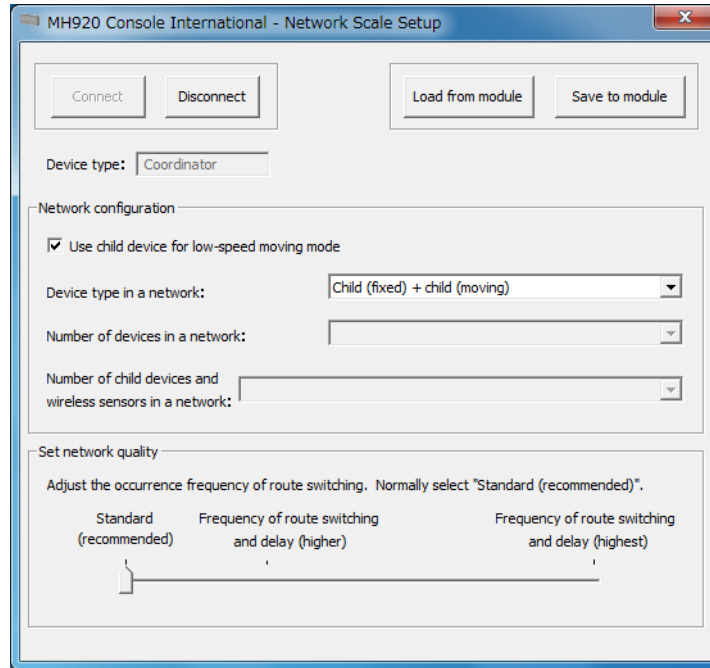

■ **Setting the information**

Click **Connect**, set the following items, and click **Save to module** to apply the set information to the wireless communication module.

Item	Description
Use child device for low-speed moving mode	Select the check box to use low-speed moving mode.
Device type in a network	Select the type of device in the network from the following: • Child (fixed) + child (Moving)
Number of devices in a network	You cannot select this.
Number of child devices and wireless sensors in a network	You cannot select this.
Set network quality	Select the network quality from the following: • Standard (recommended) • Frequency of route switching and delay (higher) • Frequency of route switching and delay (highest)

Note

- To apply the settings entered in the Network scale setup window to the wireless communication module, click **Save to module**, and then restart the module by turning the main unit's power off and then back on or by pressing the reboot switch.
- Be sure to match the Number of devices in a network to the number of routers with the same PAN ID (group number). In addition, be sure to set the same network scale for routers with the same PAN ID (group number). Otherwise, data omission or router disconnection may occur.
- For wireless communication modules with the Network join mode set to Fast join mode, the Use child device for low-speed moving mode check box is not available.

■ Loading the current settings from the wireless communication module

Click **Connect** and then **Load from module** to load the current settings from the wireless communication module. You can change the network scale based on the loaded information.

4.9 Other Functions (Tool Menu)

This section describes the functions that are available on the Tool menu of the coordinator configuration selection window or router configuration selection window. The following functions are available.

- Display topology
- RSSI measurement
- Get Log
- Firmware update
- Cancel radio transmission time display
- Restore factory preset

Displaying the Topology (Display topology)

The topology (network connection configuration) from the wireless communication coordinator module to the routers is displayed.

How to open this window:

- In the main window, click **Coordinator configuration**. In the coordinator configuration selection window, click **Display topology** on the **Tool** menu.

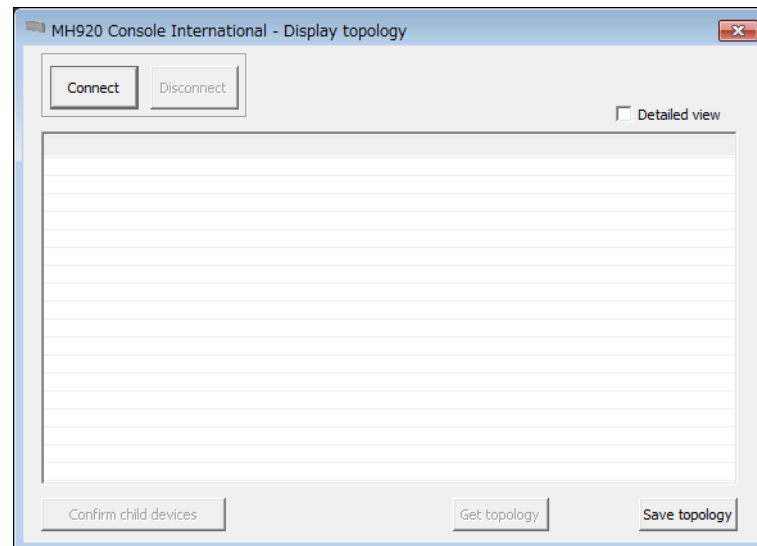

■ Loading the information from the wireless communication module

1. Click **Connect** to connect to the wireless communication coordinator module.

If a password prompt window appears, see “If Omit Password is set to No” in section 4.5.3, “Coordinator Configuration Window.”

2. Click **Get topology** to load information from the wireless communication coordinator module.

The following topology information appears.

Nothing is displayed if there are no routers, sensors.

Item	Description	Simple view
IPv6 address	The fixed digits of the IPv6 address (upper 112 bits) are displayed in the top area of the list.	—
No	The number of routers, sensors in the wireless network is displayed.	✓
Parent	“0000” is displayed.	✓
Parent MAC	The coordinator’s MAC address is displayed.	
Type	“Router” is displayed.	
1-Child	The short address of the router or wireless sensors at the first hop is displayed.	✓
1-Child MAC	The MAC address of the router or wireless sensors at the first hop is displayed.	
1-Child station number	“—” is displayed.	
1-Child type	“Child” / “Sensor” is displayed.	
n-Child	The short address of the router or wireless sensors at the nth hop is displayed.	✓
n-Child MAC	The MAC address of the router or wireless sensors at the nth hop is displayed.	
n-Child station number	When router, “—” is displayed . When wireless sensor, station number is displayed.	
n-Child type	“Child” / “Sensor” is displayed.	

The displayed information may be different from the latest topology if routers are disconnected due to changes in the radio signal condition or the like.

4.9 Other Functions (Tool Menu)

■ To check the communication with the displayed routers

With the topology information loaded from the wireless communication coordinator module showing, click Confirm child devices. Whether communication to the displayed routers is possible is confirmed (reachability check), a message indicating that the confirmation result has been saved to a file is displayed, and then the following confirmation result is displayed.

- Rows containing routers that returned responses are displayed in blue.

No	Parent	Parent MAC	Parent type	1-Child	1-Child MAC	1-Child st...	1-Child type
001	0000	00:80:87:00:09:10:38	Parent	0001	00:80:87:00:09:10:3D	-	Child

- Rows containing routers that did not return responses are displayed with gray shading.

No	Parent	Parent MAC	Parent type	1-Child	1-Child MAC	1-Child st...	1-Child type
001	0000	00:80:87:00:09:10:38	Parent	0001	00:80:87:00:09:10:3D	-	Child

- Rows containing routers that are being confirmed or not yet confirmed are displayed in black.

No	Parent	Parent MAC	Parent type	1-Child	1-Child MAC	1-Child st...	1-Child type
001	0000	00:80:87:00:09:10:38	Parent	0001	00:80:87:00:09:10:3D	-	Child

- To cancel the confirmation of routers, click Interruption.
- By default, the results (pass/fail) of whether the routers have been reached is saved to C:\OKI\MH920 Console International\Log\Log_topology_MAC address_date and time.txt.

■ To save a backup of the displayed information

Click **Save topology** to save the loaded topology information with the specified file name in the specified folder. By default, the file is saved with the following file name in the following folder.

- C:\OKI\MH920 Console International\Node_Log\MAC address_TOP_date and time.txt

You cannot close the Display topology window while connected.

Measuring the routers' RSSIs [RSSI measurement] (version 4.4 and later)

The RSSIs between the routers and their preferred parents can be displayed.

How to open this window:

In the main window, click Coordinator configuration. In the coordinator configuration selection window, click RSSI Measurement on the Tool menu.

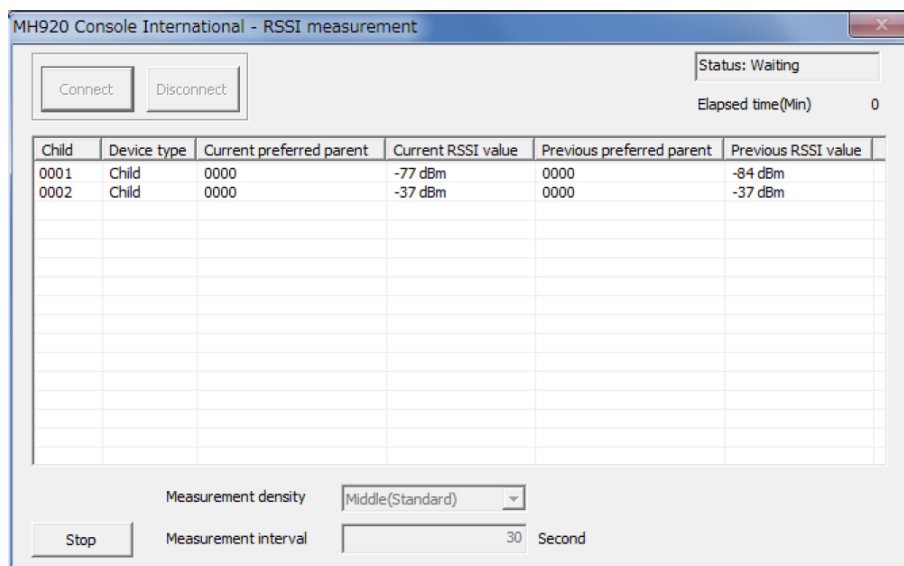

■ To perform an RSSI measurement

1. Click Connect to connect to the wireless communication module (coordinator module).

- If a password prompt window appears, see “If Omit Password is set to No” in section “4.5.3 Coordinator Configuration Window” on page 4-9

2. Set the measurement density and measurement interval.

Set the parameters used in the measurement.

Parameter	Description	Notes
Measurement Density	Select the measurement density from the following: High Middle (Standard) Low	Default: Middle (Standard) High: 1 Sec Middle (Standard): 3 Sec Low: 15 Sec
Measurement interval	Enter the measurement interval (1 to 3600Sec).	Default: 30 Sec

Measurement density sets the interval from when the RSSI measurement of the current router is completed until the RSSI measurement is sent to the next router, thereby adjusting the load on the network.

Measurement interval sets the time from when the RSSI measurement of all routers is completed until a list of routers is obtained again to start another RSSI measurement.

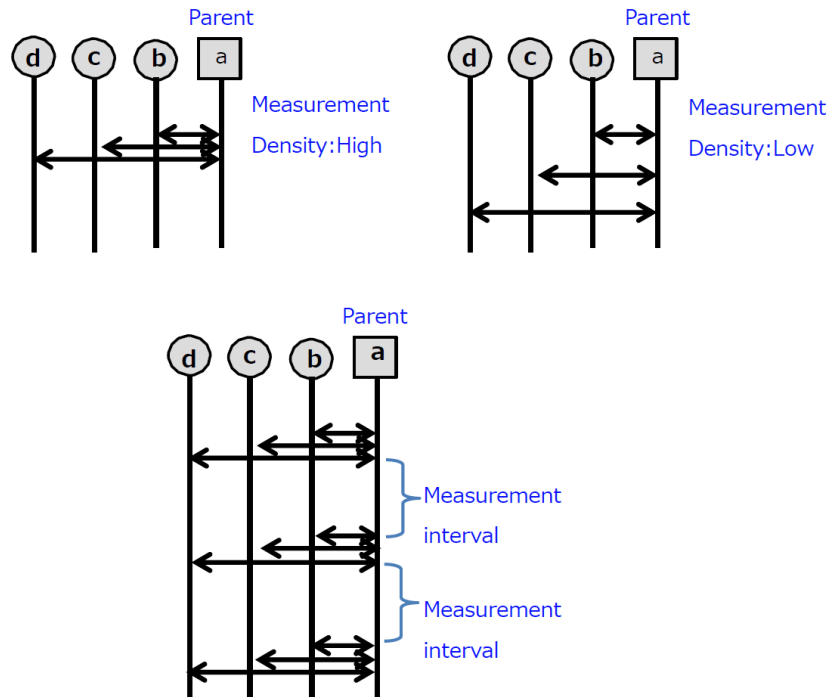

- In an RSSI measurement, communication takes place between the coordinator and each router. Because of this, the network load increases during an RSSI measurement and may affect data transfer.
- If the measurement interval is set to a short time period, it may not cause the RSSI measurement result to change.

4.9 Other Functions (Tool Menu)

3. Click Start to start an RSSI measurement.

The following information appears.

Nothing is displayed if there are no routers.

Parameter	Description	Display timing
Child	Displays the router's short address.	After obtaining a list of routers
Device type	Displays the router type. Child Sensor	After obtaining a list of routers
Current preferred parent	Displays the preferred parent's short address.	After obtaining a list of routers
Current RSSI value	Displays the RSSI measurement result.	After obtaining the RSSI measurement result
Previous preferred parent	Displays the previous preferred parent's short address.	After obtaining a list of routers (2nd and subsequent iterations)
Previous RSSI value	Displays the previous RSSI measurement result.	After obtaining a list of routers (2nd and subsequent iterations)

- If the preferred parent's short address is 0000, it signifies a coordinator.
- Because there is a time lag from when a list of routers is obtained until the RSSI measurement is executed, changes in the radio wave conditions or the like may cause the preferred parent information on the screen or in the log to be different from the preferred parent at the time of the RSSI measurement.
- If a router is disconnected due to changes in the radio wave conditions or the like, the RSSI measurement of that router will time out, and "-" will be shown for the RSSI measurement.
- If the router type is something other than Router, "Excluded" will be shown for the RSSI measurement.
- While a measurement is in progress, do not turn off the wireless unit or remove the MicroUSB cable. If you do, the RSSI measurement will be aborted, and the connection will be cut off.
- An RSSI measurement stops 24 hours after it is started.
- To stop an RSSI measurement, click Stop.
- By default, RSSI measurement results are saved to the following file.
C:\OKIMH920 Console International\RSSI_Log\Rssi_date/time_MAC_address.csv

The following information is recorded in a measurement result file.

Parameter	Description
No	Displays the executed sequence number. The number returns to 1 when one iteration of measuring the routers in the network is completed.
Time	Displays the date and time the measurement result was obtained.
Child	Indicates the router's short address.
Device type	Indicates the router type. Child Sensors
Preferred parent	Indicates the preferred parent's short address.
RSSI value	Indicates the RSSI measurement result.

- A separator character string is inserted after obtaining the information from all routers (one iteration).
- Depending on the router information acquisition conditions and the load conditions of the PC running the maintenance console software, results may be recorded at intervals different from the measurement interval.
- If a router is disconnected due to changes in the radio wave conditions or the like, the RSSI measurement of that router will time out, and "-" will be shown for the RSSI measurement.
- If the router type is something other than Router, "Excluded" will be shown for the RSSI measurement.

- How to use the RSSI measurement results:
Communication may not be stable for a router with a poor RSSI value or a router whose preferred parent changes frequently.

Saving the log information of the wireless communication module (Get log)

You can collect various log information (communication log, failure log) from the wireless communication module and save it in the maintenance console PC. You can also delete the logs stored in the wireless communication module.

How to open this window:

- In the main window, click **Coordinator configuration**. In the coordinator configuration selection window, click **Get Log** on the **Tool** menu.
- In the main window, click **Router configuration**. In the router configuration selection window, click **Get Log** on the **Tool** menu.

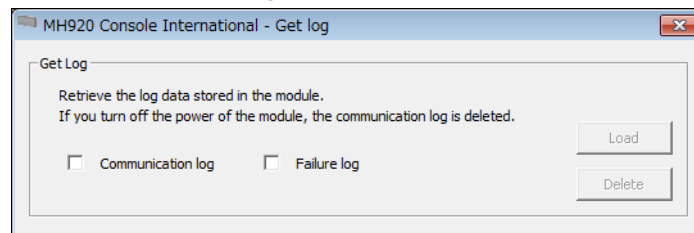

■ To download logs to the maintenance console PC

Select the check boxes for the logs you want to load, and click **Load**. The logs are saved with the following file names in the specified folder (default folder: C:\OKI\MH920 Console International\Node_Log\).

Log type	File name
Communication log	MAC address_COM_date and time.txt
Failure log	MAC address_ERR_date and time.txt

MAC address: MAC address of the connected wireless communication module

If a password prompt window appears, see "If Omit Password is set to No" in section 4.5.3, "Coordinator Configuration Window."

■ To delete logs stored in the wireless communication module

Select the check boxes for the logs you want to delete, and click **Delete**. The selected log data is deleted from the wireless communication module.

Updating the firmware (Firmware update)

You can load a specific firmware file into the maintenance console and update the wireless communication module firmware.

How to open this window:

- In the main window, click **Coordinator configuration**. In the coordinator configuration selection window, click **Firmware update** on the **Tool** menu.
- In the main window, click **Router configuration**. In the router configuration selection window, click **Firmware update** on the **Tool** menu.

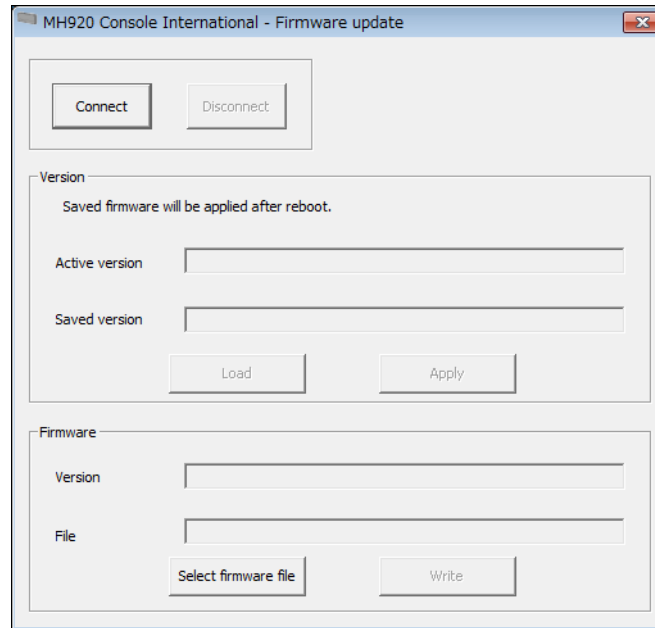

■ To update the wireless communication module firmware

You can update the firmware as follows:

1. Connect to the wireless communication module.

Click **Connect** to connect to the wireless communication module.

If a password prompt window appears, see “If Omit Password is set to No” in section 4.5.3, “Coordinator Configuration Window.”

2. Check the firmware version of the wireless communication module.

Click **Load** to display the current firmware versions in the Active version and Save version boxes.

3. Select the firmware file.

Click **Select firmware file**, and specify the file for updating the firmware. Check that the file name of the wireless communication coordinator module firmware is “MH920-Mod-CIN-fxxxxxx.dat.” Also check that the file name of the wireless communication router module firmware is “MH920-Mod-RIN-fxxxxxx.dat.” Specifying firmware files with different names displays a dialog box shown on the below. The firmware version is read from the specified file. The version is displayed in the Version box and the file path in the File box.

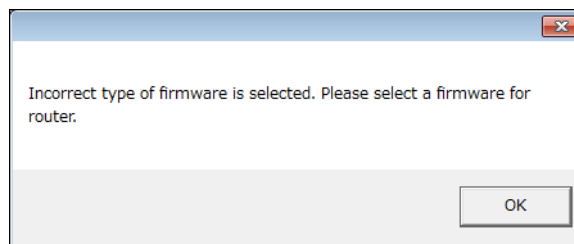

Note

Carefully check the firmware file name to confirm that you have selected the correct file. If you select an incorrect file, the module may stop operating.

4. Transfer the firmware information to the wireless communication module.

Click **Write** to transfer the firmware information to the wireless communication module.

5. Update the wireless communication module firmware

Click **Apply**. The wireless communication module is restarted (reset), and then the firmware is updated. If you do not click **Apply**, firmware updating will not finish.

If the updated firmware is earlier than the firmware version used before, to clear the added functions, execute **Restore factory preset** after updating the firmware.

Canceling the radio transmission time display (Cancel radio transmission time display)

When the wireless communication module displays the radio transmission time display, you can cancel the display from the maintenance console.

How to open this window:

- In the main window, click **Coordinator configuration**. In the coordinator configuration selection window, click **Cancel radio transmission time display** on the **Tool** menu.
- In the main window, click **Router configuration**. In the router configuration selection window, click **Cancel radio transmission time display** on the **Tool** menu.

Clicking **Cancel radio transmission time display** shows the following message.

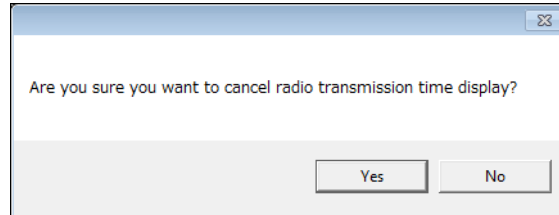

If you click **Yes**, the radio transmission time display is canceled, and the following message appears.

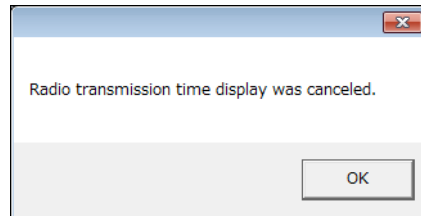

Click **OK** to finish.

Restore factory preset

You can restore the settings of the connected wireless communication module to their factory default values.

Note

When you execute **Restore factory preset**, all the current settings are cleared. Save the settings to a configuration file in advance.

Note

Settings that result by performing this operation are different from the default settings of SMARTDAC+ and UTAdvanced.

How to open this window:

- In the main window, click **Coordinator configuration**. In the coordinator configuration selection window, click **Restore factory preset** on the **Tool** menu.
- In the main window, click **Router configuration**. In the router configuration selection window, click **Restore factory preset** on the **Tool** menu.

Clicking Restore factory preset shows the following message.

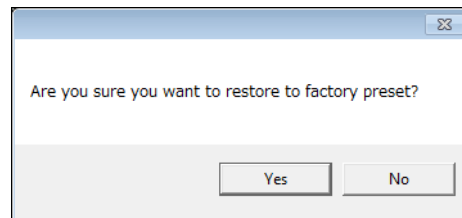

If you click **Yes**, a message for confirming the restarting of the module appears. Clicking **OK** restarts the wireless communication module and restores the module to factory preset.

Note

- The factory default Network join mode is V3-compatible mode, regardless of the firmware version.
- If you are handling a wireless communication module in the factory default condition, do not perform Load from module using the MH920 Console International. Instead, configure the necessary settings using the MH920 Console International, and perform Save to module. Because there are settings with different default values between the MH920 Console International and the firmware, the module will not operate properly.

4.10 Measurement tool

MH920 Console International (maintenance console) has a channel noise scan tool and communication test tool as measurement tools.

4.10.1 Channel Noise Scan Tool

The channel noise scan tool measures the RSSI values (reception signal strength) of the specified channel at a given time interval. By using a channel not used in the vicinity, you can use this tool without interfering with the radio signals.

This section explains the following operations.

- Switching the wireless communication module to measurement mode
- Performing a channel noise scan

Switching the wireless communication module to measurement mode

Before starting the channel noise scan tool (measurement tool you want to use), change the wireless communication module to measurement mode by following the procedure below.

1. Check the wireless communication module's antenna settings and the connection.
2. Connect the wireless communication module to the maintenance console PC with a USB cable, and turn on the wireless communication module.
3. Specify the COM port that the wireless communication module is connected to.

In the Environment setup window of the maintenance console, click the COM port drop-down list, select the COM port that the wireless communication module is connected to, and then click **Set**.

4. Display the measurement tool selection window.

In the maintenance console's main window, click **Measurement tool**.

5. Switch the wireless communication module to the appropriate measurement mode according to the measurement tool type.

In the measurement tool selection window (shown below), select the measurement tool type you want to use (Channel noise scan in this example), and then click **Change mode**.

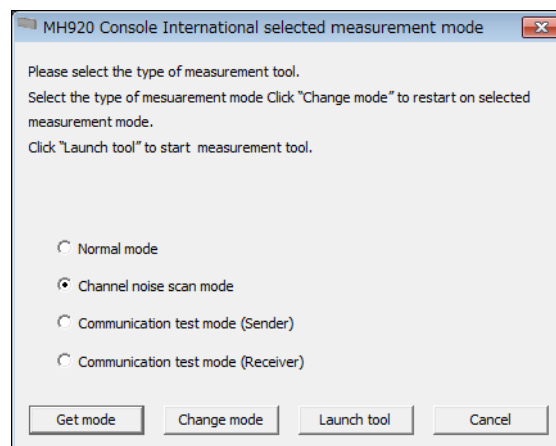

If a password prompt window appears, see “If Omit Password is set to No” in section 4.5.3, “Coordinator Configuration Window.”

A message indicating that the wireless communication module has been changed to measurement mode appears. Click **OK**.

6. Check the LED status of the wireless communication module.

Check that ST1 (green/red) and ST2 (green/red) of the wireless communication module are as shown in the following table, and then proceed to the next step.

LED indication in measurement mode and the selected measurement tool type

Measurement tool type	ST1 (green/red)	ST2 (green/red)
Channel noise scan	ST1 (green/red) On/off simultaneously Repeated	ST2 (green/red) On/off simultaneously Repeated
Communication test (transmission)	ST1 (red) On/off Repeated	ST2 (red) On/off Repeated
Communication test (reception)	ST1 (red) On/off Repeated	ST2 (green/red) On/off simultaneously Repeated

Performing a channel noise scan

Perform a channel noise scan by following the procedure below.

Note

While a measurement is in progress, do not turn off the wireless communication module or remove the USB cable. If you do, an error message will appear, and the channel noise scan tool will be forcibly closed.

1. Change to measurement mode, and then start the channel noise scan tool.

After performing the procedure explained in “Switching the wireless communication module to measurement mode,” with Channel noise scan selected in the measurement tool selection window (the window shown below), click **Launch tool**.

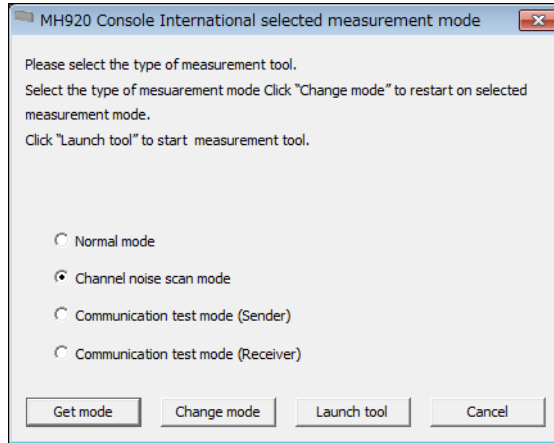

The following window appears.

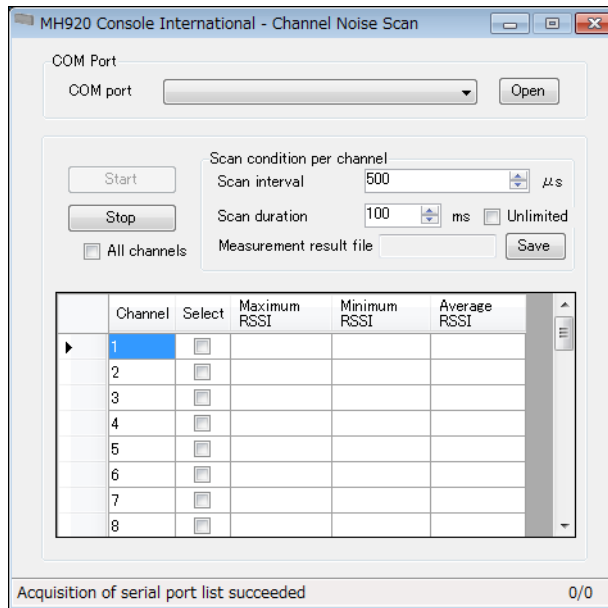

2. Specify the COM port that the wireless communication module is connected to.
Click the COM port drop-down list, select the COM port that the wireless communication module is connected to, and then click **Open**.

If the COM port does not appear, check the power state of the wireless communication module and the USB cable connection.

3. Set the scan interval and scan duration.

For example, if you set the scan interval to 500 (μs) and scan duration (measurement duration) to 100 (ms) for the scan (measurement) conditions of each channel, measurement will be performed 200 times at 500 (μs) intervals over 100 (ms) (see the equation below).

Number of channel noise measurements per channel

$$= (\text{scan duration [ms]} \times 1000) \div \text{scan interval } [\mu\text{s}]$$

If you select the **Unlimited** check box, measurement will be repeated until you click **Stop**.

If you do not select the check box, the number of measurements is up to 2000 times.

4. Specify the channels you want to measure.

Select the channel numbers by selecting the check boxes in the Select column or by selecting the **All channels** check box.

5. If you want to save the measurement result file with a specified name in a specified folder, click **Save** next to Measurement result file, and then specify the folder name and file name.

If you do not specify the folder name or file name, the result file is saved according to the following rules.

- Folder: C:\OKI\MH920 Console International\CH-Noise_Log\
- File name: CHN_yymmdd-HHMMSS.csv

yy: year, mm: month, dd: day, HH: hour, MM: minute, SS: second

Contents of the measurement result file

Item	Description
Time	The date and time of measurement
Channel	The channels that were measured
Interval	The measurement interval [μs].
Times	The number of channel noise measurements per channel
RSSI	The RSSI value for the measurement

4.10.2 Communication Test Tool

The communication test tool is used to measure the RSSI values and packet error rate (PER) between two wireless communication modules. You can configure one wireless communication module for transmitting and another for receiving and perform tests to confirm the wireless communication quality in the actual installation environment in advance. During a communication test using the measurement tool, however, devices operate only as transmitters or receivers, not as repeaters.

You first start the communication test tool, configure the two wireless communication modules for transmitting and receiving, and then perform communication tests on the receiving end. Perform the following operations in order.

- Setting the first wireless communication module to communication test mode (sender)
- Setting the second wireless communication module to communication test mode (receiver)
- Performing a communication test

Setting the first wireless communication module to communication test mode (sender)

Set the first wireless communication module to communication test mode (sender) by following the procedure below. The wireless communication module set to sender mode will continue to send test data intermittently until the mode is changed from measurement mode back to normal mode. In addition, the transmitter output in measurement mode will be the value set with **Transmitter power output** on the Basic configuration tab of the Coordinator module configuration or router module configuration.

1. Perform the procedure explained in “Switching the wireless communication module to measurement mode,” to switch to measurement mode.

Connect the wireless communication module that will be configured as the sender, and then set the measurement tool type to **Communication test mode (Sender)** to switch the measurement mode.

You can set the transmitter output for measurement mode by setting **Transmitter power output** as explained in “Setting the Terminal Information of the Wireless Communication Module (Basic configuration tab).”

2. Open the Communication test (Sender) window.

With Communication test mode (Sender) selected in the measurement tool selection window (the window shown below), click **Launch tool**.

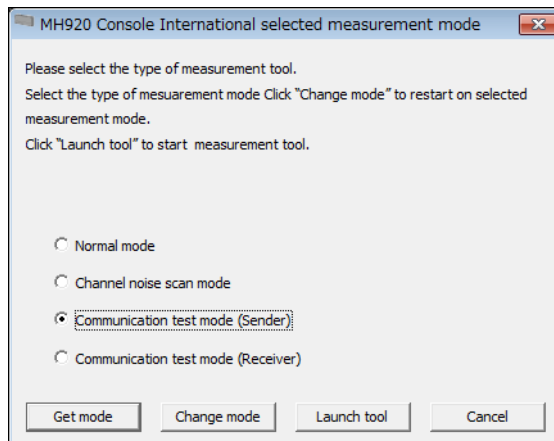

The following window appears.

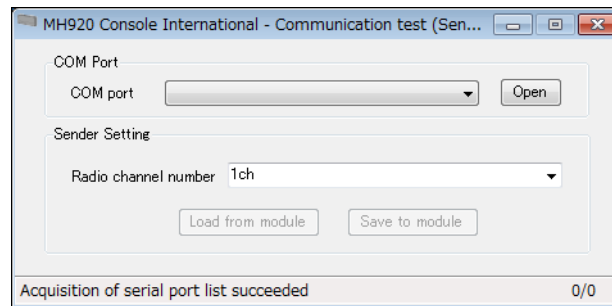

3. Specify the COM port that the sender wireless communication module is connected to. Click the COM port drop-down list, select the COM port that the wireless communication module is connected to, and then click **Open**.
4. Specify the channel for sending radio signals.
To use the channel number set in the wireless communication module, click **Load from module**. To specify a new channel, click the **Radio channel number** list, select the channel number, and then click **Save to module**.
 - The same channel number must be set on the second wireless communication module (receiver), so take a note of this channel number.
 - The channel number you specify here is the channel number for communication testing. Setting the channel number in the wireless communication module here will not change the settings in normal mode.
5. When configuration is complete, click **Close** to close the COM port, and then click **x** to close the Communication test (Sender) window.

This completes the configuration of the first wireless communication module for communication test (sender). The module is already sending radio signals. Next, set the second wireless communication module to communication test mode (receiver).

Setting the second wireless communication module to communication test mode (receiver)

Set the second wireless communication module to communication test mode (receiver) by following the procedure below. In communication tests, the wireless communication module configured to be the receiver performs the measurements.

1. Perform the procedure explained in “Switching the wireless communication module to measurement mode,” to switch to measurement mode.
Connect the wireless communication module that will be configured as the receiver, and then set the measurement tool type to **Communication test mode (Receiver)** to switch the measurement mode.

Note

- After changing to measurement mode, do not perform any operation other than starting the communication test (sender) tool. To perform other operations, set the wireless communication module back to normal mode by executing step 4 in “Performing a communication test” first.
- If you turn off the module in measurement mode, the module will start in the selected measurement mode the next time the power is turned on.

- Open the Communication test (Receiver) window.

With Communication test mode (Receiver) selected in the measurement tool selection window (the window shown below), click **Launch tool**.

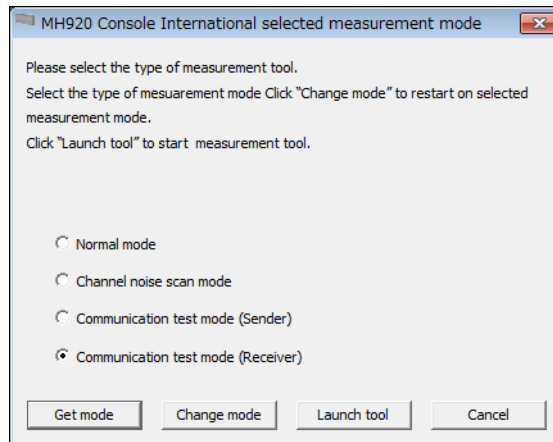

The following window appears.

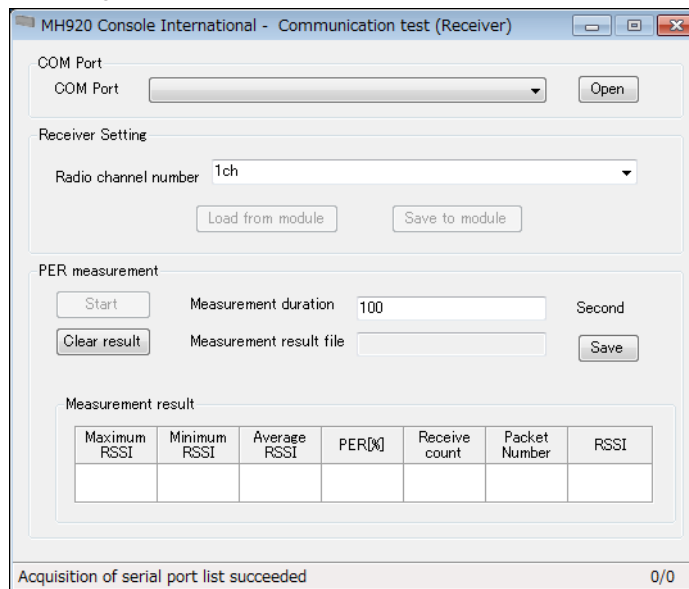

- Specify the COM port that the receiver wireless communication module is connected to. Click the COM port drop-down list, select the COM port that the wireless communication module is connected to, and then click **Open**.
- Specify the channel for receiving radio signals. Set the same channel number as that set on the first wireless communication module (sender). Click the **Radio channel number** list, select the channel number, and then click **Save to module**.

To check the channel number set in the wireless communication module, click **Load from module**.

This completes the configuration of the second wireless communication module for communication test (receiver). Start the communication test on the wireless communication module configured to be the receiver.

Performing a communication test

After configuring the second wireless communication module to be the receiver, start the communication test on the same module.

1. In the Communication test (Receiver) window, specify the measurement duration and the save destination of the measurement result file (if necessary).

Set the measurement duration in unit of seconds in the range of 1 to 600000 seconds. To specify the save destination of the measurement result file, click **Save** next to Measurement result file. By default, the file is saved with the following file name in the following folder.

- Folder: C:\OKI\MH920 Console International\PER_Log
- File name: PER_yymmdd-HHMMSS.csv
yy: year, mm: month, dd: day, HH: hour, MM: minute, SS: second

2. After specifying the measurement duration and the like, click **Start** to start the communication test.

When measurement starts, values are displayed under Measurement result. Further, the measurement results are saved to the specified file.

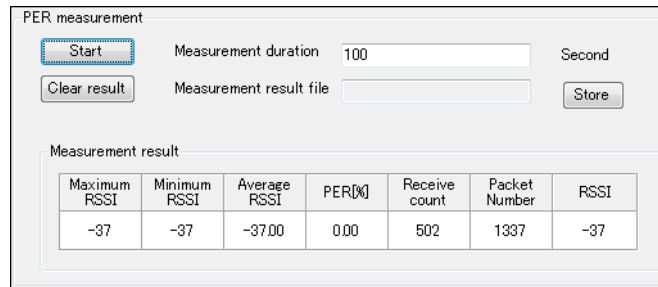

Item	Description
Maximum RSSI	The maximum RSSI value in the measurement results
Minimum RSSI	The minimum RSSI value in the measurement results
Average RSSI	The average RSSI value of the measurement results
PER[%]	The packet error rate during measurement
Receive count	The number of packets received during the measurement duration.
Packet Number	The latest received packet number (the number of the packet sent by the wireless communication module set to communication test mode (sender))
RSSI	The RSSI value of the latest received packet

If you want to install wireless communication modules in fixed locations, we recommend that the modules be used in an environment with 0.00* PER and greater than or equal to -90 average RSSI.

If you want to use wireless communication modules in low-speed moving mode, we recommend that the modules be used in an environment with 0.00* PER and greater than or equal to -80 average RSSI.

* Even when the PER value is 0.00, communication errors may occur during normal operation due to environmental fluctuations and effects from other wireless devices.

3. When measurement is complete, click **Close** to close the COM port, and then click **x** to close the Communication test (Receiver) window.
4. Switch the wireless communication module from measurement mode to normal mode.
In the measurement tool selection window, select **Normal mode**, and then click **Change mode**.

Also set the first wireless communication module (sender) back to normal mode.

5.1 List of Settings

5.1.1 Overview of Configuration Files

A configuration file holds various maintenance settings of a wireless communication module. By creating a configuration file (in csv format) according to the environment, you can simply load the file in the maintenance console to apply the settings to a wireless communication module at once. Make sure to use the maintenance console to create configuration files. Further, view the contents of configuration files by loading them into the maintenance console.

- For details on creating configuration files, see “Saving the configuration file (Save Configuration button)” in section 4.5.3, “Coordinator Configuration Window,” or “Saving the configuration file (Save Configuration button)” in section 4.6.3, “Router Configuration Window.”
- For details on loading configuration files, see “Loading the configuration file (Load Configuration button)” in section 4.5.3, “Coordinator Configuration Window,” or “Loading the configuration file (Load Configuration button)” in section 4.6.3, “Router Configuration Window.”

The following seven configuration items can be written in configuration files.

- Basic configuration
- Communication setup
- Protocol setup
- Packet filtering
- Station number setup
- Fixed route setup
- Password setup

5.1 List of Settings

5.1.2 Basic Configuration Items

These items are for entering the terminal information of the wireless communication module. The following table shows the items, their description, and whether they can be set.

Item	Description	Coordinator module	Router module
Network join mode	Set the network join mode (Fast join mode or V3-compatible mode). If there are wireless devices with firmware version v3.x in the network or wireless devices used in low-speed moving mode, select V3-compatible mode .	Required	Required
Low-speed moving mode	For router modules, select whether they are moving a low speeds.	N/A	Required
PAN ID (group number)	Coordinator: Enter the PAN ID (0001 to FFFE) to connect to. Router: Enter the preferred PAN ID (0000, 0001 to FFFE) to connect to. • To not specify the preferred PAN ID, enter 0000.	Required	Optional
Radio channel number	Specify the channel number (1 to 43 ch or 1 to 14 ch). • For coordinators, one channel can be selected. For routers, up to 10 channels can be selected.	Required	Required
Short address	Enter a different short address (0001 to FFFD) for each router module. • When connecting several wireless routers, be sure the addresses do not overlap. • For router modules, do not set the address to 0000.	N/A	Required
Network name	Enter using up to 16 alphanumeric characters. • You can use hyphens, underscores, spaces, colons, and ampersands.	Required	Required
Encryption key	Enter the encryption key (hexadecimal: 32 digits).	Required	Required
Prefix	Enter the higher 64 bits of the IPv6 address. (*)	Required	N/A
MAC address authentication	Select whether to perform MAC address authentication. • If you select Yes, the allow radio device list and refuse radio device list are enabled.	Required	N/A
Antenna setup	Set the antenna type and diversity. This is not available for antenna set by hardware.	Required	Required
Radio utilization rate restriction	0.00 to 99.99 % Default: 10.00 %	Required	Required
Monitoring Unit Time of Radio Transmission	Enter the monitoring unit time of radio transmission utilization rate (10 to 3600 seconds).	Required	Required
Transmitter power output	Select the signal level (0.16 mW, 1 mW, 20 mW) for the US radio transmission. Select the signal level (0.16 mW, 1 mW, 5 mW, 12.5mW) for the Korea radio transmission.	Required	Required
Retry times before route switching	Set the number of retries (1, 2, 3) before switching the communication route when communication fails from the coordinator to a router.	Required	Required

*: When terminal information is obtained before the first configuration after purchase or after resetting the settings to their factory defaults, be sure to set the prefix.

5.1.3 Communication Setup Items

These items are for entering the serial interface information between the wireless communication module and motherboard. The following table shows the items, their description, and whether they can be set.

Item	Description	Coordinator module	Router module
Equipment Connection	Select whether devices are connected or whether the module is used as a dedicated repeater (without device connections).	N/A	Required
Bit rate	Select 115200 bps.	Required	Required
Bit length	The bit length is fixed to 8 bit.	Required	Required
Stop bit	Select the stop bit (1 bit).	Required	Required
Parity	Select the parity (None).	Required	Required

5.1.4 Protocol Setup Items

Enter the protocol information. The following table shows the items, their description, and whether they can be set.

Item	Description	Coordinator module	Router module	
Station number analysis	For coordinators, specify station number analysis (enabled or disabled).	Required	N/A	
Data transmission interval when transmitting to all the child devices	If Station number analysis is set to No, set the interval for transmitting data from the coordinator to each router.	Required	N/A	
Protocol type	Specify the protocol type (Modbus (RTU) or Other (ASCII)).	Required	N/A	
Station number analysis	Presence of broadcast address	Specify whether a broadcast address is available.	Required	N/A
/Modbus (RTU)	Presence of broadcast address	If a broadcast address is available, enter the address (decimal: 0 to 255).	Required	N/A
Station number analysis	Packet filtering	Set the packet filtering function to None, Yes (notification type), or Yes (polling type).	Required	N/A
	Filter timeout on polling	Set the timeout value to use with the packet filtering function.	Required	N/A

5.1.5 Packet Filtering Setup Items

Enter the filtering function information for unneeded data from devices. The following table shows the items, their description, and whether they can be set.

Item	Description	Coordinator module	Router module
Packet filtering	Set the packet filtering function to None, Yes (notification type), or Yes (polling type).	N/A	Required
Filter timeout on polling	Set the timeout value (0, 10 to 600 × 100 milliseconds) to use with the packet filtering function.	N/A	Required

5.1.6 Station Number Setup Items

Enter the specification method of station numbers. The following table shows the items, their description, and whether they can be set.

Item	Description	Coordinator module	Router module
Specification method of Station numbers	Select the specification method of Station numbers (List, Range). (*) • If you select List, set the station number list. • If you select Range , select the maximum number of multidrops (1/1 to 4/1 to 8/1 to 16/1 to 31).	Required	N/A

*: To use no station number analysis mode, set **Station number analysis** to No on the Protocol setup tab.

5.1.7 Fixed Route Setup Items

Enter the information for the fixed route function. The following table shows the items, their description, and whether they can be set.

Item	Description	Coordinator module	Router module
Fixed route	Enables or disables the fixed route function.	N/A	Required(*)
Destination short address	Set the short address of the fixed connection destination.	N/A	Required(*)
Temporary detour	When the fixed route function is enabled, you can enable or disable detour transmission.	N/A	Required(*)

* If router modules are used in low-speed moving mode, the item cannot be set.

5.1.8 Password Setup Items

Enter the password for connecting wireless modules.

Item	Description
Password	Enter the new password (5 to 8 characters).

Appendix 1 Troubleshooting

App 1.1 Unable to Connect to Network

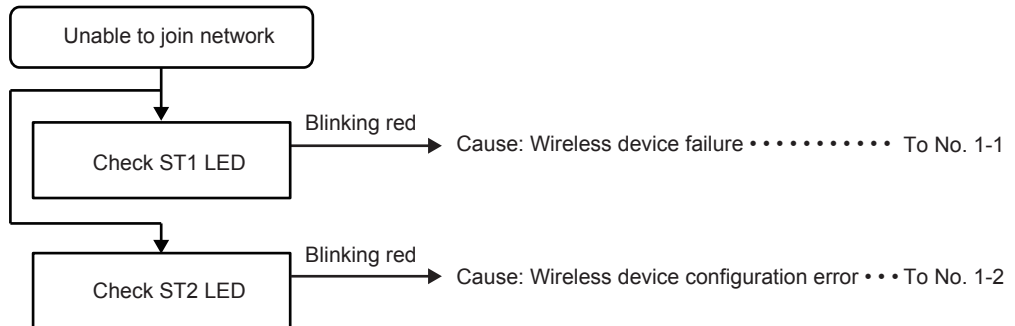

No	Corrective action
1-1 Cause: Wireless device failure	
1-1	The wireless device may not be working properly, so change it.
1-2 Cause: Wireless device configuration error	
1-2	<p>[If all devices show the same phenomenon] The encryption key set in the coordinator may be different from that indicated on the parameter sheet. Connect the maintenance console to the coordinator, and set the encryption key exactly as indicated on the parameter sheet.</p> <ul style="list-style-type: none"> Maintenance console window: Coordinator configuration > Module setup > Basic configuration > Encryption key <p>[If only certain devices show the same phenomenon] * when MAC address authentication is disabled The encryption key set in the routers may be different from that indicated on the parameter sheet. Connect the maintenance console to the routers, and set the encryption key exactly as indicated on the parameter sheet.</p> <ul style="list-style-type: none"> Maintenance console window: Router configuration > Module setup > Basic configuration > Encryption key <p>[If only certain devices show the same phenomenon] *When MAC address authentication is enabled The MAC address of the applicable router registered in the MAC address list of the coordinator may be different from the MAC address of the actual device. Connect the maintenance console to the coordinator, and check whether the MAC address of the applicable router is set correctly.</p> <ul style="list-style-type: none"> Maintenance console window: Coordinator configuration > Module setup > Basic configuration > MAC address authentication > Edit MAC address list > Allow radio device list <p>[If only certain devices show the same phenomenon] *When MAC address authentication is enabled The encryption key of the applicable router registered in the MAC address list of the coordinator may be different from the encryption key set on the actual device. Connect the maintenance console to the coordinator or router, and set the encryption key correctly.</p> <ul style="list-style-type: none"> Maintenance console window: Coordinator configuration/Router configuration > Module setup > Basic configuration > Encryption key

App 1.2 Unable to acquire data

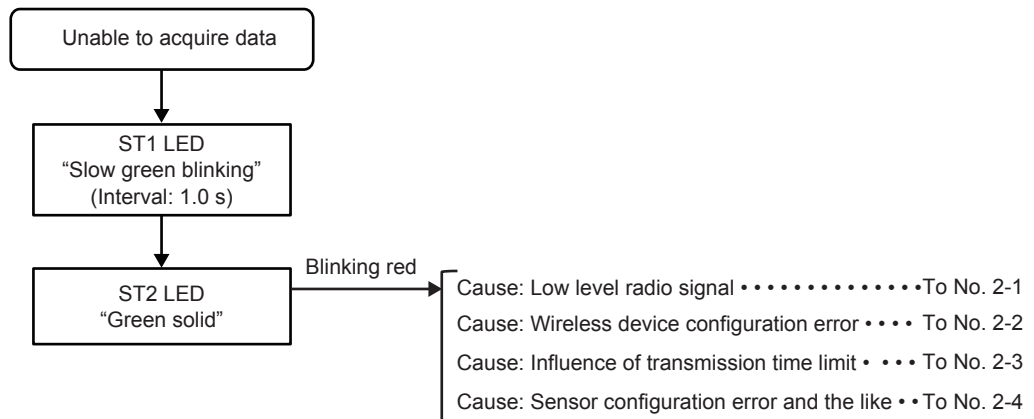

No	Corrective action	
2-1 Cause: Low level radio signal		
2-1	The antenna direction may not be appropriate. Adjust the direction. Change the antenna to a cable type (roof top antenna), and change the installation location of the antenna.	
	The wireless device may be outside the radio range. Install a repeater. The installation environment may be outside the guaranteed operating range. Check the installation environment. • Check the guaranteed operating conditions.	
	Radio interference may be occurring due to the ambient environment (e.g. shield). Change the installation location if you can move the wireless device. If you cannot, install a repeater.	
	2-2 Cause: Wireless device configuration error	
	2-2	The station number and short address pairs set in the station number list of the coordinator may be not be correct. Connect the maintenance console to the coordinator, and set the correct station number and short address pairs. • Maintenance console window: Coordinator configuration > Module setup > Station number setup > Station number list
The maximum number of multidrops set in the coordinator may not be correct. Connect the maintenance console to the coordinator, and set the correct maximum number of multidrops. • Maintenance console window: Coordinator configuration > Module setup > Station number setup > Specification method of Station numbers > Station number list		
The protocol set in the coordinator may not be correct. Connect the maintenance console to the coordinator, and set the Modbus protocol. • Maintenance console window: Coordinator configuration > Protocol setup > Protocol type		
The short address set in the router may not be correct. Connect the maintenance console to the router, and set the correct short address. • Maintenance console window: Router configuration > Module setup > Basic configuration > Short address		
The association between the coordinator configuration value and the short address derived from the station number may not be correct. Review the station number and short address design, connect the maintenance console to the router, and set the correct short address. • Maintenance console window: Router configuration > Module setup > Basic configuration > Short address		
2-3 Cause: Influence of transmission time limit		
2-3	There may be a great number of sensors connected to a single router causing the transmission time to be longer. This may cause some of the data to be discarded due to the data transmission time limit. Add routers in order to reduce the number of sensors connected to a single router.	
	There may be a great number of sensors connected to a single router causing the transmission time to be longer. This may cause some of the data to be discarded due to the data transmission time limit. Connect the maintenance console to the coordinator, and change the radio utilization rate restriction. • Maintenance console window: Router configuration > Module setup > Basic configuration > Radio utilization rate restriction	

No	Corrective action
2-4	2-4 Cause: Sensor configuration error and the like
2-4	The sensors may be turned off. Check the sensor power supplies.
	The sensor station numbers may be not correct. Check the sensor station numbers.
	Sensors may have malfunctioned. Change the sensors.
	Check that the packet filtering function's enabled/disabled state in Protocol setup are matched between the coordinator and routers.
	If the packet filtering function is enabled in the coordinator's Protocol setup, the timeout value may not be appropriate. Set the timeout value to a value obtained by subtracting the fixed overhead (1 second) from the filter timeout on polling of the host device (e.g., logger).
	The filter timeout on polling of the host device (e.g., logger) may be too short. Tune the filter timeout on polling by considering the time required in the wireless segment (roundtrip). See section 5.4.5, "Monitoring Unit Time of Radio Transmission."
	If the packet filtering function is enabled in the router's Protocol setup, the timeout value may not be appropriate. Set the timeout value longer than the time required for data to be transmitted from the router's sensors to the router.

App 1.3 Long time to acquire data

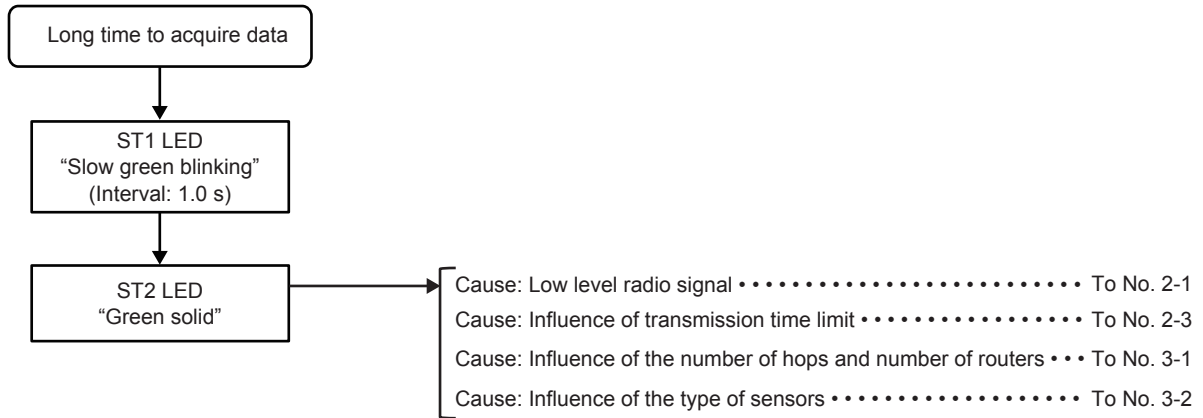

No	Corrective action
3-1 Cause: Influence of the number of hops and number of routers	
3-1	There may be too many number or router hops in a single network. Add a coordinator, and divide the routers into two networks.
	There may be too many routers in a single network. Add a coordinator, and divide the routers into two networks.
3-2 Cause: Influence of the number of sensors	
3-2	There may be too many sensors in a single network. Add a coordinator, and divide the routers into two networks.

App 1.4 Maintenance console error

No. 4-1. "Communication error: Module response timeout"

"Failed to read module settings. COM port became unusable during communication. Check the cable connection and power supply status."

"Module connection failed. COM port setting is incorrect, or is not specified. Set COM port from the "Preferences" menu and re-run."

No	Corrective action
4-1 Cause: COM port detection failure	
4-1	Disconnect the Mini USB cable, and connect it again.
4-1 Cause: COM port configuration error	
4-1	The specified COM port may not be correct. Using the maintenance console, change the COM port to the same port as the connected PC. • Maintenance console window: Environment setup > COM port
4-1 Cause: Mini USB cable not connected	
4-1	The Mini USB cable may not be connected to the maintenance console PC. Check the connection. The Mini USB cable may not be connected to the wireless device. Check the connection.
4-1 Cause: Broken Mini USB cable	
	The Mini USB cable may not be broken. Change to a different Mini USB cable, and check whether it operates properly.
4-1 Cause: The wireless device is not turned on.	
4-1	See No. 1-1 of section 1.1.
4-1 Cause: Wireless device failure	
4-1	See No. 1-2 of section 1.1.

No. 4-2. "Login failed"

No	Corrective action
4-2 Cause: Wireless device password error	
4-2	Reset the password set in the wireless device.

No. 4-3. "Password format is incorrect"

No	Corrective action
4-3 Cause: Wireless device password not entered	
4-3	Reset the password set in the wireless device.

No. 4-4. "Setting failed"

No	Corrective action
4-4 Cause: Mismatched firmware version and maintenance console version (*)	
4-4	Use a maintenance console version that corresponds to the firmware version in use.
4-4 Cause: IPv6 is disabled on the maintenance console PC in use.	
4-4	Enable the IPv6 setting.
4-4 Cause: The OS running on the PC is not compatible with the maintenance console.	
4-4	Use an OS version that is compatible with the maintenance console.

No. 4-5. "Setting failed"

No	Corrective action
4-5: The wireless device has not been restarted to apply the changes made to the protocol settings.	
4-5	After changing the settings, restart the wireless device by turning the power switch off and then back on or by pressing the reboot switch.

App 1.5 Other Problems

Description of problem	Corrective action
The coordinator does not start properly.	Check the PAN-ID of the coordinator. When you start the coordinator, if there are wireless devices using the same PAN-ID and same channel in the radio range, the coordinator cannot complete the startup operation.
Data dropout occurs during serial data communication.	This may occur on the wireless coordinator and routers if the packet filtering function is not configured properly. Check that the packet filtering function on the wireless coordinator and routers is configured in the same way. Data loss, data retransmission, and deviation in data update interval may occur due to wireless communication verification procedures, system operating environment, degradation in wireless communication quality, communication route errors and recovery, and so on.

Appendix 2 Frequently Asked Questions

App 2.1 Inquiries about Hardware Specifications

Q:	What are the maximum number of routers that can connect to a single coordinator and the maximum number of hops?
A:	The maximum number of routers that connect to a single coordinator is 100. The maximum number of hops is 16.

Q:	What is the range of 920 MHz radio waves?
A:	The line-of-sight distance that radio waves can reach is at least 800 m (for the US radio transmission) or 700 m (for the Korea radio transmission), at a height of 1.5 meters above the ground. But in buildings, city areas, and other locations with numerous obstructions, the attenuation in the radio signal becomes large, and the signal may not travel as far as expected. The influence on radio signals varies greatly depending on the environment, so we recommend that you investigate the radio environment at the installation location in advance using the communication test tool available in the wireless device.

App 2.2 Inquiries about Functional Specifications

Q:	What happens if the routers are turned on before the coordinators are turned on?
A:	Routers, after they start, search the network until a connection destination is found.

Q:	In a multi-hop configuration, if a repeater reaches radio utilization rate restriction (initial 10%), will the routers covered by the repeater also not be able to communicate?
A:	If a repeater wireless device violates radio utilization rate restriction, routers connected under the repeater will also no longer be able to communicate. However, if such routers have detour routes through a different repeater when communication failure is detected, communication continues through the detour route or set the radio utilization rate restriction to 0.00%.

Q:	What happens when radio utilization rate restriction is applied?
A:	Wireless devices that reach the 10% duty transmission time limit will not be able to transmit radio signals for a given time period.

App 2.3 Inquiries about Installation

Q:	How should the channel numbers to be used be selected?
A:	By using the channel noise scan function that is available as standard in wireless devices, you can check the radio usage condition of each channel. Check the radio usage condition at the planned installation location, and select channels with low noise. For details on the channel noise scan function, see section 4.10, "Measurement Tool."
Q:	Can other antennas sold in the market be used?
A:	Using antennas and extension cables sold in the market violates the certification of conformance to technical standards, so they cannot be used. Disconnecting or altering the antennas and extension cables sold by YOKOGAWA also violates the certification of conformance to technical standards.
Q:	Can other antenna extension cables sold in the market be used?
A:	Using antennas and extension cables sold in the market violates the certification of conformance to technical standards, so they cannot be used. Disconnecting or altering the antennas and extension cables sold by YOKOGAWA also violates the certification of conformance to technical standards.

App 2.4 Inquiries about Configuration

Q:	When I configure the station number list using the maintenance console, the station number list is cleared. Why?
A:	If you register the station number list when there is no list in the maintenance console or when a station number list has not been loaded from the wireless device, the station number list registered in the wireless device will be deleted.
Q:	When I change the settings using the maintenance console while performing channel noise measurement, the measured values are in error. Why?
A:	Do not change the parameters while a channel noise measurement is in progress.
Q:	When the coordinator is restarted after updating the firmware, it does not start properly. Why?
A:	When you restart the coordinator, if there are wireless devices using the same PAN-ID and same channel in the radio range, the coordinator cannot complete the startup operation.
Q:	Data dropout occurs during serial data communication. Why?
A:	This may occur on the wireless coordinator and routers if the packet filtering function is not configured properly. Check that the packet filtering function on the wireless coordinator and routers is configured in the same way. Data loss, data retransmission, and deviation in data update interval may occur due to wireless communication verification procedures, system operating environment, degradation in wireless communication quality, communication route errors and recovery, and so on.
Q:	Is it better to change the network name and encryption key from the default values in the wireless device configuration?
A:	We recommend you change the network name, PAN-ID, encryption key, and channel number from the default values set in the MH920 Console International.
Q:	Can the communication test mode in the maintenance console measurement tool be used when communication is taking place via repeaters?
A:	Communication test mode in the maintenance console measurement tool only supports network configuration consisting of only transmitters and receivers (repeaters are not supported).

Appendix 3 Different Versions and Connectivity

The following table shows the connectivity of wireless devices (coordinators and routers) described in this document.

		Wireless device (coordinator)	
		v4.x (fast join)	v4.x (v3 compatible)
Wireless device (router)	vf4.x (fast join)	Y	N
	vf4.x (v3 compatible)	N	Y

vf4.x: Wireless module firmware version

Y: Connection possible

N: Connection not possible

Appendix 4 Terminology

Term	Description
900MHz	Compared to the 2.4 GHz band used by wireless LAN and the like, the 900 MHz band features a longer radio range and better characteristics of bending around obstacles. As such, it can be used when longer communication distance is necessary and when there are many obstacles in the area.
Diversity	Diversity refers to the technique of improving communication quality and reliability by prioritizing the use of wireless signals received from antennas with the best radio reception when the same signal is received through multiple antennas.
Multi-hop	Wireless multi-hop communication refers to the method of transmitting data through other wireless communication devices just like a bucket brigade. Because communication can be accomplished without a communication infrastructure (e.g., base station), the method is used widely in sensor networks and the like.
PAN	An acronym for Personal Area Network. In this document, the term refers to the wireless multi-hop network for communication between wireless devices.
RSSI	An acronym for Received Signal Strength Indication. The term refers to the circuit or signal used to measure the intensity of signals that wireless communication devices receive. It is used for controlling the transmission range of wireless communication.
Polling	This term refers to a communication method in which a host device sends a command to a specific sensor connected to a router, and the sensor returns a unique response to the host device.
Notification type	This term refers to a communication method in which the commands sent from the host device to sensors that are connected to routers and the responses returned from those sensors are not unique to each sensor.

Appendix 5 System Operation Considerations

This section explains the steps to install a data acquisition system that uses wireless devices. Write down the settings that you decide to use for each item in the parameter sheet, and refer to them when configuring or installing wireless devices.

- (1) Confirming the components of the installation environment
- (2) Choosing the areas to use wireless communication
- (3) Selecting the required devices and their quantity
- (4) Reviewing the wireless device parameter values

App 5.1 Confirming the Components of the Installation Environment

Confirm the installation locations of the data acquisition devices, sensors, and the like in the wireless device installation environment and their connection destinations. Further, confirm the types and the number of devices that are required, the serial interface specifications, and the RS485 protocol type.

If there are multiple data acquisition devices that are installed, perform the above confirmation procedures for each data acquisition device.

As an example, we will consider designing a wireless communication network using wireless devices in a building with data acquisition devices and sensors installed as shown in Fig. 5.1.

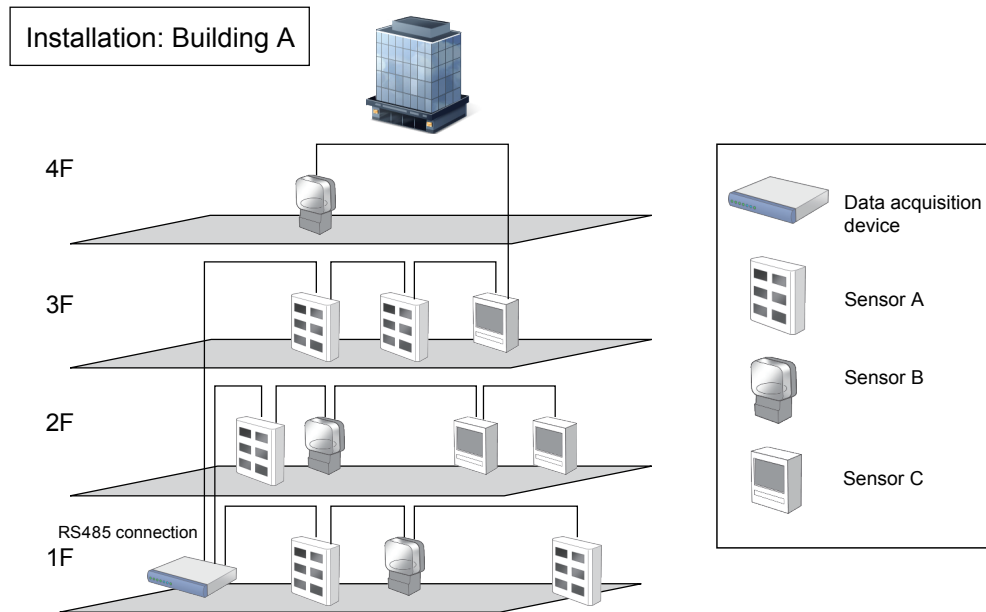

Fig. 5.1 Installation environment

App 5.2 Determining the Areas to Use Wireless Communication

First, choose the areas to use wireless communication in the installation environment. Because a wireless coordinator is always connected to a data acquisition device, check the location where the coordinator will be connected and configure the multidrop connection in order to determine the maximum number of sensors that will be connected through wiring. In this configuration example, connections between floors and connections between sensors that are far apart on the same floor will be connected over wireless.

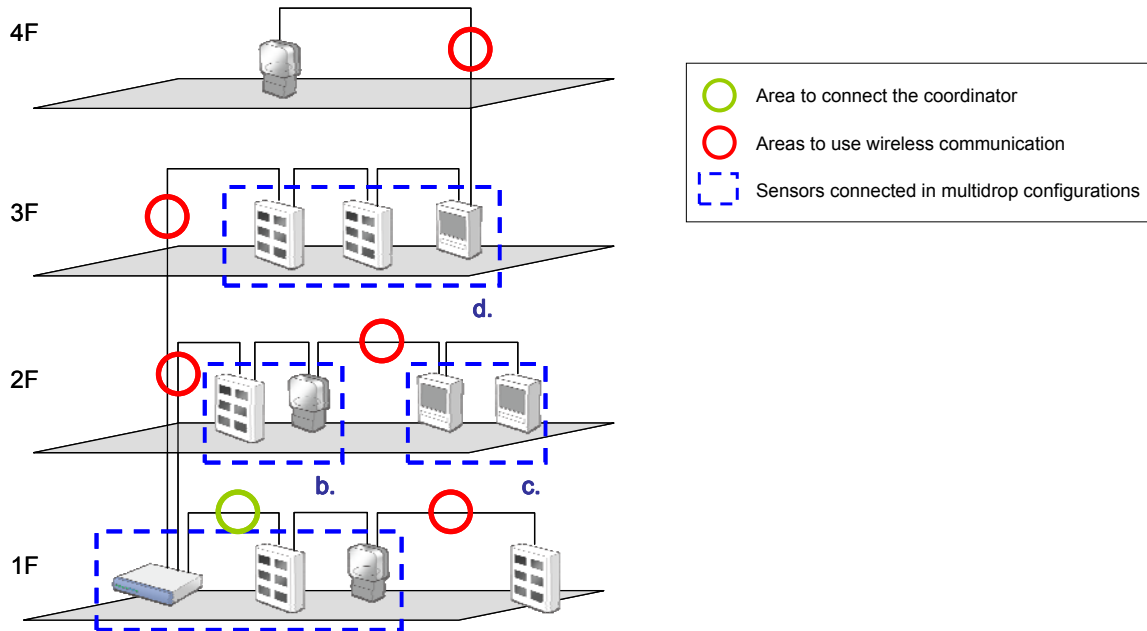

Fig. 5.2 Determining the areas to use wireless communication

Wireless connection will be set up between the data acquisition device on the first floor to the sensor located far away on the same floor, for the connection to the second floor, for the connections to sensors (a) located far away on the second floor, for the connection to the third floor, and for the connection between the third and fourth floors.

After the wireless devices are installed, the radio environment will be measured. For details on measuring the radio environment, see section 4.10, “Measurement Tool.” We recommend a radio environment in which the measured PER is 0%* and the average RSSI is greater than or equal to -90 dBm.

* Even when the PER value is 0.00, communication errors may occur during normal operation due to environmental fluctuations and effects from other wireless devices.

App 5.3 Selecting the Required Devices and Their Quantity

After making the considerations in section 5.2, we have chosen connect the components as shown in Fig. 5.3. Table 5.1 shows the minimum number of wireless devices that will be necessary.

Table 5.1 Number of required wireless devices

Wireless device type	Product name	Quantity
Parent	GX20/CM2, GP20/CM2	1
Router	UT32A (with 920 MHz wireless communication)	4
	GM10/CS2	1

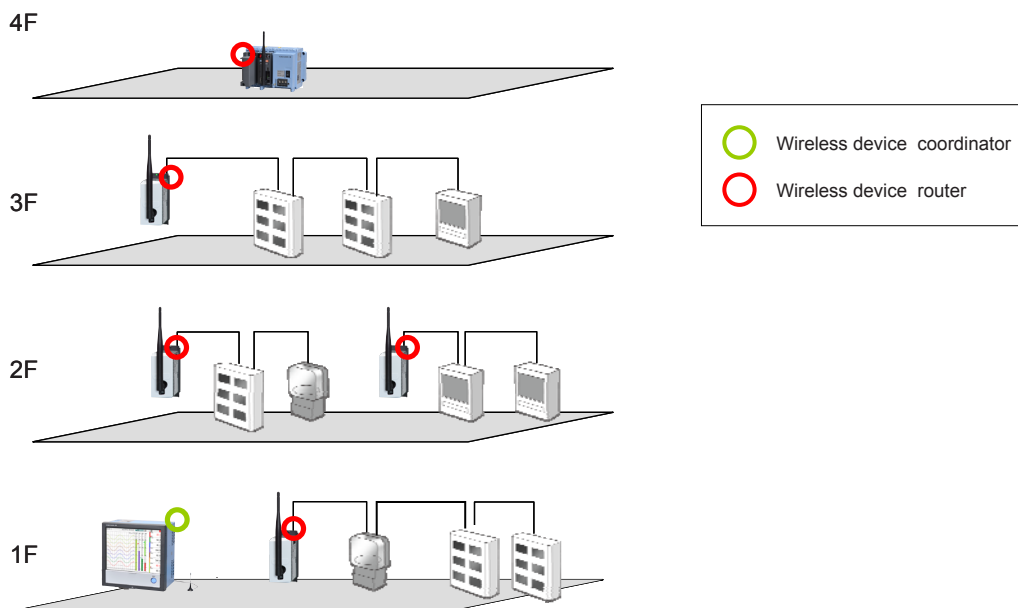

Fig 5.3 Wireless configuration

App 5.4 Reviewing the Wireless Device Parameter Values

To configure the multi-hop network using wireless devices, we choose the wireless device parameter values shown in Table 5.2.

Note that the values shown in section 5.4.1 and later are examples.

Table 5.2 Wireless device configuration parameters

Parameter	Parent	Router	Reference
Network join mode	R	R	App 5.4.1
PAN ID (group number)	R	R	App 5.4.2
Radio channel number	R	R	App 5.4.3
Network name	C	C	App 5.4.4
Radio utilization rate restriction	C	C	App 5.4.5
Monitoring Unit Time of Radio Transmission	C	C	App 5.4.5
Transmitter output	C	C	App 5.4.6
Retry times before route switching	C	C	App 5.4.7
Encryption key	C	C	App 5.4.8 (1)
MAC address authentication	D	—	App 5.4.8
Allow radio device list	D	—	App 5.4.8 (2)
Refuse radio device list	D	—	App 5.4.8 (3)
IPv6 prefix	D	—	App 5.4.9
Short address	—	R	App 5.4.10
Interface type	R*1	R*1	
Equipment Connection	—	R	
Serial settings	R	*2	
Protocol settings	R	*2	
Detail protocol settings	C	C	
Packet filtering	R	R	App 5.4.11
Station number analysis	R	—	App 5.4.10
Specification method of Station numbers	R	—	App 5.4.10
Station number list	*3	—	App 5.4.10 (1)
Fixed route setup	—	D	App 5.4.12
Network scale setup	R*4	R*4	App 5.4.13
Password for connecting to the wireless device	D	D	App 5.4.14

R: Configuration required

C: Default values can be used, but changing them is recommended.

—: Configuration not possible

D: Default values of the maintenance console can be used.

*1: You cannot change this parameter while connected to the device.

*2: Set this parameter when Equipment Connection is set to Yes.

*3: Set this parameter when Specification method of Station numbers is set to List.

*4: Change this parameter according to the network scale.

*5: We recommend you change the network name, PAN-ID, and encryption key from their default values set in the MH920 Console International.

App 5.4.1 Network Join Mode

You can set the network join mode on wireless devices.
 There are two types of network join modes: Fast join mode and V3-compatible mode.
 The above two modes can be specified for wireless devices with firmware version vf4.x.
 Fast join mode allows devices to join a network quickly.
 The minimum network join time of a wireless device is about 5 seconds.
 V3-compatible mode allows connection to a network consisting of wireless devices with
 firmware version v3.x.
 The minimum network join time of a wireless device is about 30 seconds.
 Set the same network join mode for all wireless devices in the same network.

Table 5.3 Network join mode

Target	Configuration	Parameter specification and range	Notes
Parent	Mandatory	Fast join mode, V3-compatible mode	To add wireless devices to a network configured for firmware version v3.x, select V3-compatible mode .
Router	Mandatory	Fast join mode, V3-compatible mode	To add wireless devices to a network configured for firmware version v3.x, select V3-compatible mode .

For this configuration model, select **Fast join mode**.
 If you want to add wireless devices to a network configured for firmware version v3.x, select **V3-compatible mode**.

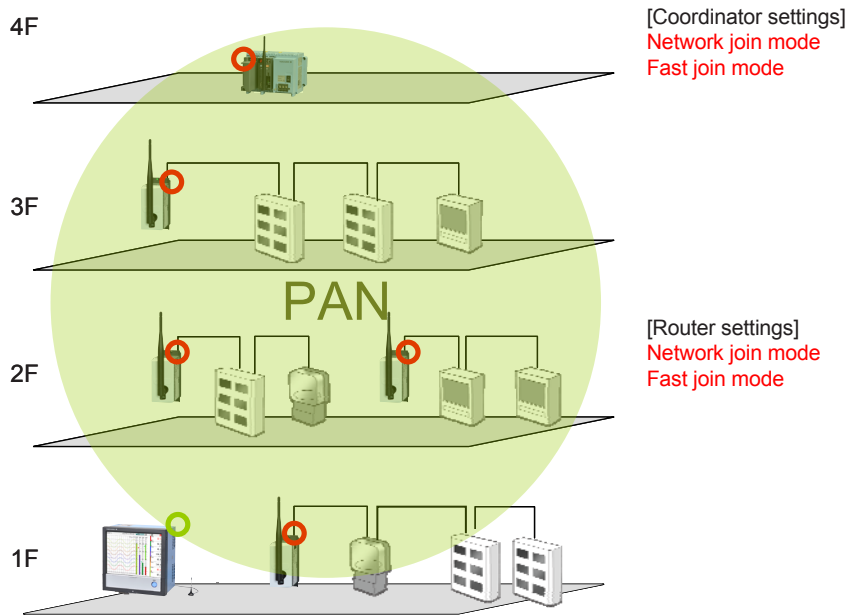

Fig. 5.4 Network join mode for the configuration example

App 5.4.2 PAN ID (group number)

Wireless devices configure a wireless multi-hop network (wireless PAN) under the coordinator.

The wireless coordinator configures a PAN using its assigned channel number (frequency band). A PAN ID is assigned as an identifier to this PAN. Make sure that this PAN ID is a unique ID for each coordinator.

A preferred PAN ID can be set in each of the wireless repeaters and routers. If a preferred PAN-ID is specified, connection to that PAN-ID is prioritized, regardless of the RSSI (radio strength). If the specified PAN ID does not exist within range of the repeater or router or if network join authentication fails using the PAN ID, an attempt is made to establish a connection to the PAN with the best RSSI among the available PAN IDs (coordinators) in the network search that takes place during network connection.

If a preferred ID is not specified, the PAN with the best RSSI among the available PAN IDs (coordinators) in the network search that takes place during network connection is selected as the connection destination and the same PAN-ID as the said coordinator is automatically assigned.

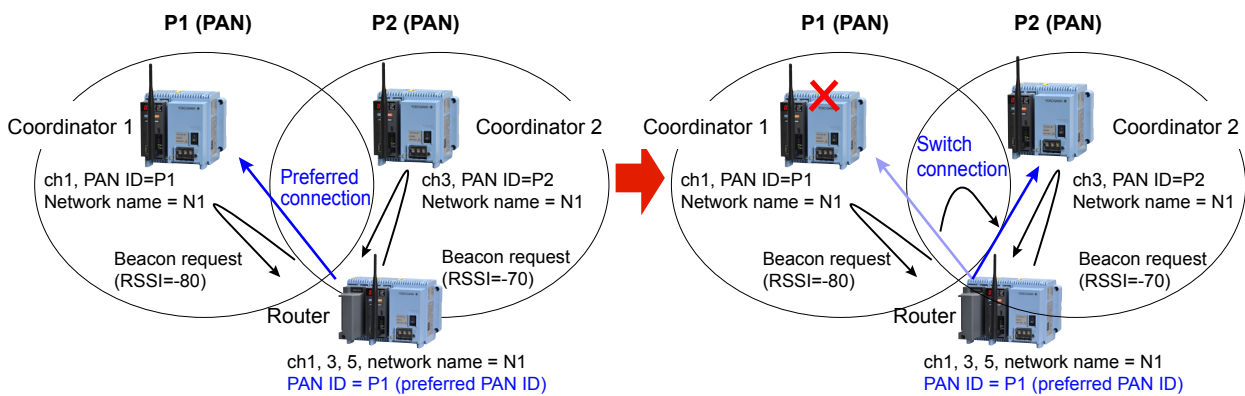

Fig. 5.5 Connection to a preferred PAN

Select the PAN ID to assign to the wireless devices from the range of values shown in table 5.4.

Table 5.4 PAN ID

Target	Configuration	Parameter specification and range	Notes
Parent	Mandatory	4 digit hexadecimal 0x0001 to 0xFFFF	Set a value that does not overlap with those of other coordinators.
Router	Optional	4 digit hexadecimal 0x0001 to 0xFFFF	Set this parameter to specify the preferred coordinator to connect to.

In this configuration example, because there is only a single coordinator in the vicinity, the PAN ID is set to the value shown in Fig. 5.6, without worrying about overlap. The same PAN ID is assigned to routers to specify the preferred PAN to connect to.

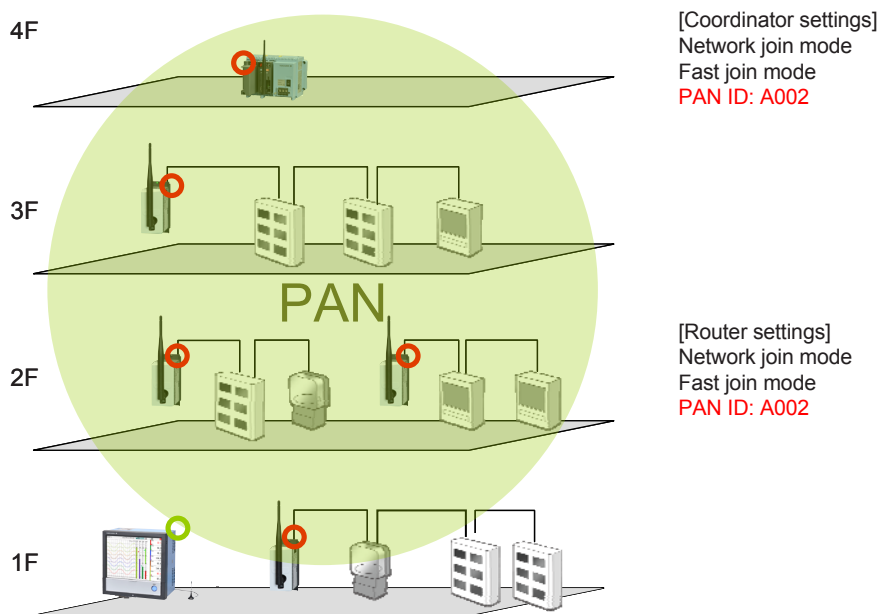

Fig. 5.6 PAN setting for the configuration example

App 5.4.3 Radio channel number

For the wireless coordinator, select the channel number to use to configure a wireless network (PAN) from the channels (1 to 43 or 1 to 14) given in table 5.5. If there is channel overlap, radio interference will occur and proper communication may be hindered, so select a different channel number from that used by other wireless device in the radio range.

Table 5.5 Channel numbers /CM2 option

Radio channel number	Center frequency	Radio channel number	Center frequency	Radio channel number	Center frequency	Radio channel number	Center frequency	Radio channel number	Center frequency
1	902.4	11	908.4	21	914.4	31	920.4	41	926.4
2	903.0	12	909.0	22	915.0	32	921.0	42	927.0
3	903.6	13	909.6	23	915.6	33	921.6	43	927.6
4	904.2	14	910.2	24	916.2	34	922.2		
5	904.8	15	910.8	25	916.8	35	922.8		
6	905.4	16	911.4	26	917.4	36	923.4		
7	906.0	17	912.0	27	918.0	37	924.0		
8	906.6	18	912.6	28	918.6	38	924.6		
9	907.2	19	913.2	29	919.2	39	925.2		
10	907.8	20	913.8	30	919.8	40	925.8		

/CM3 option

Radio channel number	Center frequency	Radio channel number	Center frequency	Radio channel number	Center frequency
1	920.7	6	921.7	11	922.7
2	920.9	7	921.9	12	922.9
3	921.1	8	922.1	13	923.1
4	921.3	9	922.3	14	923.3
5	921.5	10	922.5		

The maintenance console has a channel noise scan tool that measures the RSSI value of each channel. Use this tool to find a channel number not used in the vicinity and assign it to the coordinator.

In addition, the RSSI value and packet error rate (PER) of a specific channel between two wireless devices can be measured (communication test measurement tool).

Check the RSSI value and PER for the channel you want to use, and use this information as reference to determine the installation location of wireless devices and whether installation of repeater nodes is necessary.

For details on how to use the tools, see chapter 4, "Using the Maintenance Console."

On wireless routers, specify channel numbers of coordinators that routers will try to connect to. You can specify up to 10 channel numbers in a router, but when multiple channel numbers are specified, channel scanning will take longer during the network search, which means it will take longer for the router to join the network.

In this configuration example, because there is only a single coordinator in the vicinity, the channel number is set to the value shown in Fig. 5.7, without worrying about overlap. We also set the routers only to the same channel number as the coordinator to limit the channel scan range.

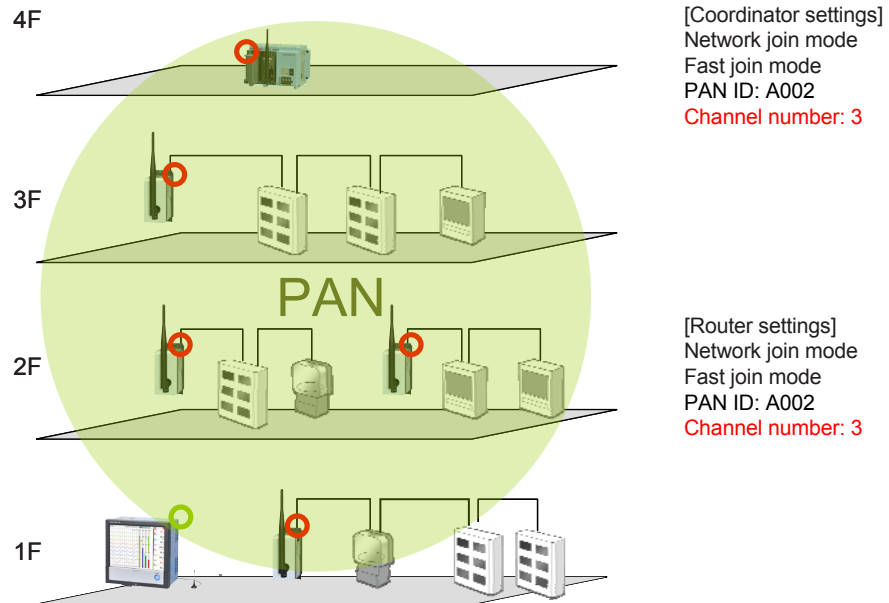

Fig. 5.7 Channel number setting in the configuration example

App 5.4.4 Network Name

When installing several wireless coordinators in adjacent areas, it is possible to assign an ID to the network configured by the wireless coordinator to prevent the routers from connecting to another coordinator. This ID is called the network name. A network name consists of up to 16 alphanumeric characters and symbols (space, hyphen, underscore, period, and ampersand).

The network name must be registered in the coordinator and every router. Routers cannot connect to a coordinator with a different network name. By using network names, you can manage PANs configured for each coordinator as separate networks.

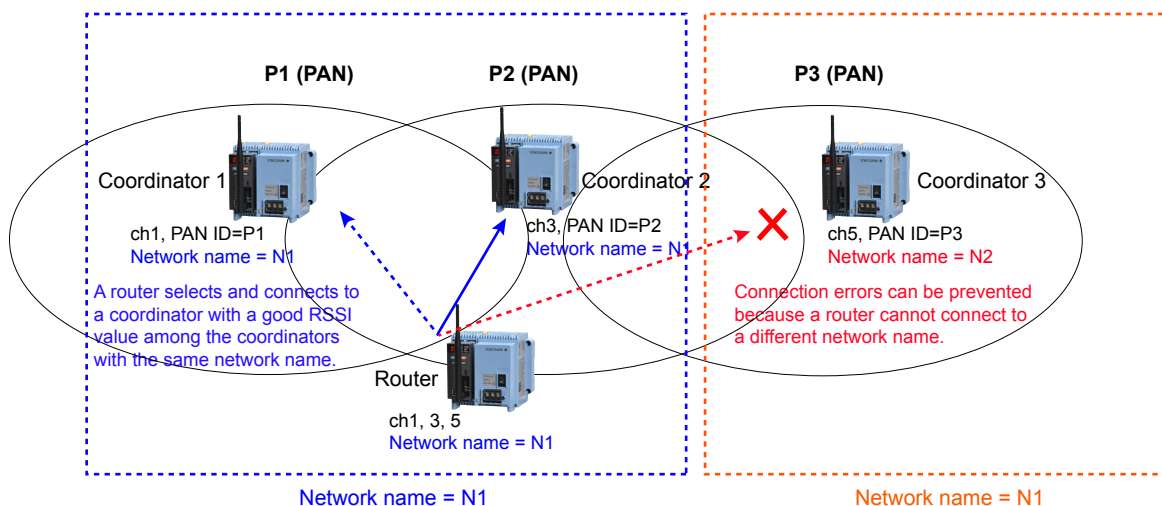

Fig. 5.8 PAN identification using network names

Select the network name to assign to the wireless devices from the range of values shown in table 5.6.

Table 5.6 Network names

Target	Configuration	Parameter specification and range	Notes
Parent	Mandatory	Up to 16 alphanumeric characters and symbols (*)	Set a value that does not overlap with those of other coordinators.
Router	Mandatory	Up to 16 alphanumeric characters and symbols (*)	Use the same value as the coordinator.

* The following five symbols can be used: space, hyphen, underscore, period, and ampersand.

In this configuration example, because there is only a single coordinator in the vicinity, the coordinator and routers are set to a common network name shown in Fig. 5.9.

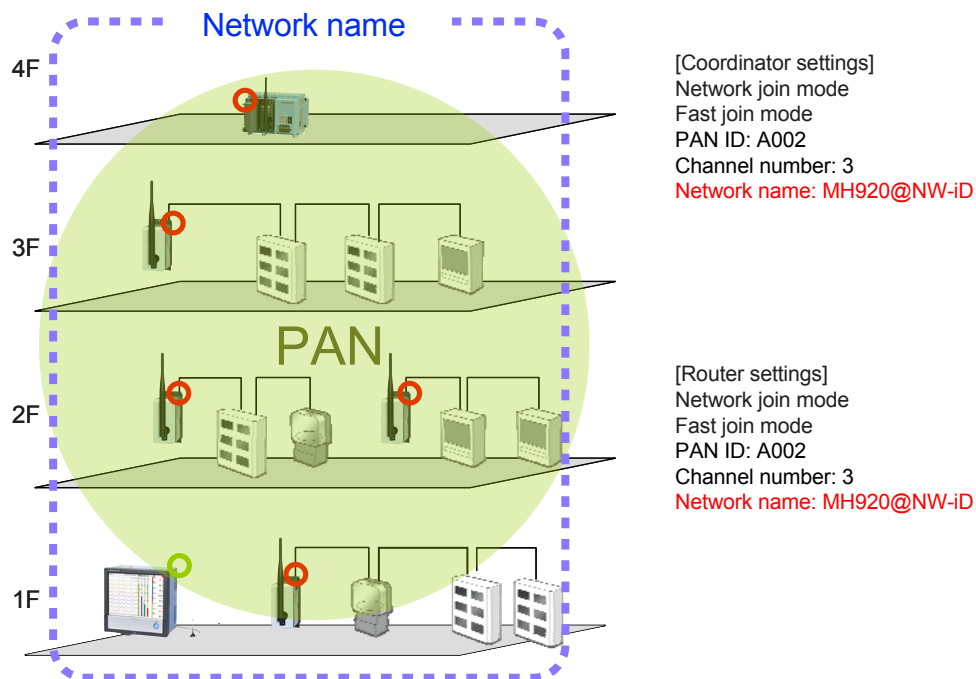

Fig. 5.9 Network name setting for the configuration example

App 5.4.5 Monitoring Unit Time of Radio Transmission, Radio utilization rate restriction
If used outside Japan, there is no limit to the transmission time. To turn off the limit function, set it as below.

Radio utilization rate restriction: 0.00%

The wireless device complies with ARIB STD-T108, a standard defined by Association of Radio Industries and Businesses (ARIB). Wireless communication that use the 920 MHz frequency band must observe the transmission time limit (Radio utilization rate restriction: 10% duty limit) defined by ARIB STD-T108. This is a characteristic communication restriction placed on communication processing as shown in Fig. 5.7. It only applies to wireless communication at 920 MHz.

Table 5.7 Radio transmission time limit in the 920 MHz frequency band in Japan

Antenna power	Applicable channel number	Unit channel bandwidth	Simultaneously used channels	Carrier sense time	Transmission time limit	Pause time	Total transmission time per hour
20 mW maximum	33-61	200 kHz	2ch	128 μs minimum	More than 3 ms, less than 200 ms	2 ms	360 s minimum
					3 ms maximum	None	

As such, wireless devices have a radio transmission time monitoring function for measuring the radio usage rate. However, because the transmission time within a given 1-hour time frame must be kept no longer than 360 seconds, the transmittable time varies depending on each “monitoring unit time of radio transmission.”

The examples shown in Fig. 5.10 are for when the radio transmission monitoring unit time is set to 60 minutes and 30 minutes, respectively. If the radio transmission monitoring unit time is set to 60 seconds, to keep the radio transmission time within 360 seconds in a given hour, the possible radio transmission time is 3 minutes because radio signals can be transmitted in the first and last 3 minutes of two consecutive radio transmission monitoring unit times. Likewise, if the radio transmission monitoring unit time is set to 30 minutes, the possible radio transmission time in 60 minutes is 4 minutes.

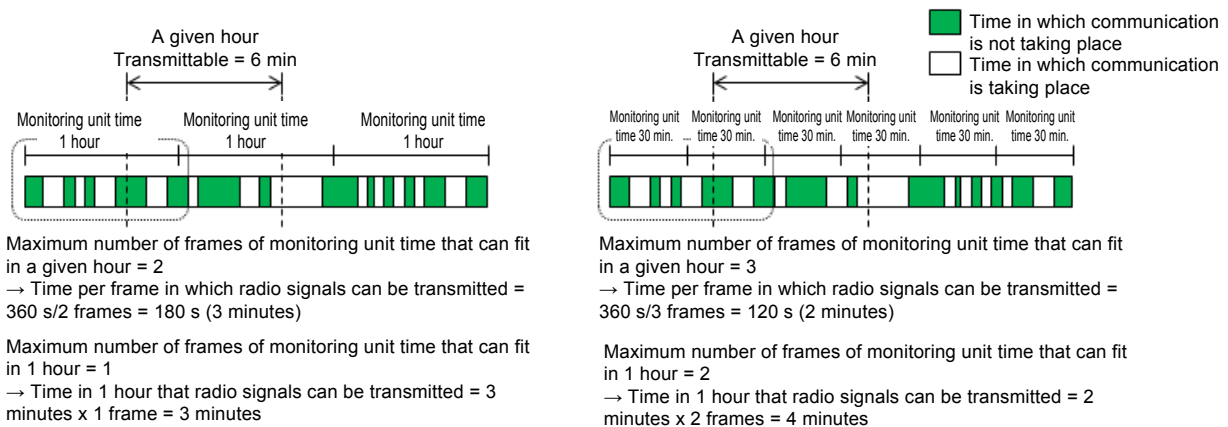

Fig. 5.10 Possible radio transmission time per radio transmission monitoring unit time

As shown in the figure, in reality, the possible radio transmission time of a wireless device is shorter than 360 seconds per hour.

If a repeater wireless device violates the 10% duty limit, routers connected under the repeater will also no longer be able to communicate. However, if such routers have detour routes through a different repeater when communication failure is detected, communication continues through the detour route. Wireless devices that reach the 10% duty transmission time limit will not be able to transmit radio signals for a given time period.

The default radio transmission monitoring unit time for the wireless coordinator and routers is 30 minutes (1,800 seconds) in the devices and 10 minutes (600 seconds) in the maintenance console.

Select the radio transmission monitoring unit time to assign to the wireless devices from the range of values shown in table 5.8.

Table 5.8 Radio transmission monitoring unit time

Target	Configuration	Parameter specification and range	Notes
Parent	Mandatory	10 to 3600 (seconds)	Device's default value: 1,800 (seconds) Maintenance console's default value: 600 (seconds) (recommended)
Router	Mandatory	10 to 3600 (seconds)	Device's default value: 1,800 (seconds) Maintenance console's default value: 600 (seconds) (recommended)

In this configuration example, we will set the radio transmission monitoring unit time to 600 seconds.

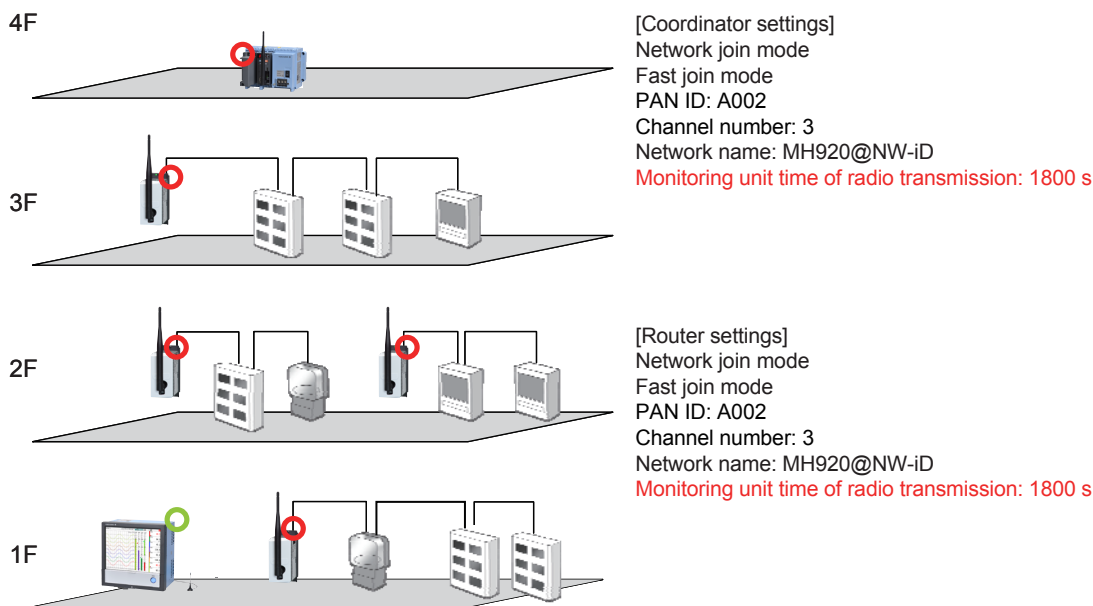

Table 5.11 Radio transmission monitoring unit time setting in the configuration example

[Reference] Handling of the 10% duty limit

Problem	Cause	Corrective action
10% duty violation occurs frequently.	<ul style="list-style-type: none"> The communication level exceeds the allowed data limit in the given wireless device topology. The radio environment is degraded and cannot use the full performance of the wireless device. 	<ul style="list-style-type: none"> Increase the data acquisition interval on the host device to reduce the frequency of communication per radio transmission monitoring unit time. To improve the wireless environment, remove obstructions, vibration sources, and the like, or move the wireless device to a better location. Perform a noise check, and change to a channel without noise influence or interference.

[Reference] Simple calculation method of the data acquisition interval

A simple calculation method of the data acquisition interval using wireless devices is shown below. Note that the value derived with this method is an approximation (with 10% duty limit considered), but this value may vary greatly depending on the radio environment.

The calculation does not take into consideration the retransmission of data acquisition requests due to timeout and the like.

Table 5.9 shows the reference command response time for reading the data of a single command by a router from the coordinator.

Table 5.9 Reference command response time

For GM10

Number of readout channels	Reference command response time (ms)
1	210
10	220
20	230
40	250
60	270
80	290
100	310
120	330
125	335

For UT52A/UT32A

Number of readout channels	Reference command response time (ms)
1	394
25	490
100	790

For UPM100

Number of readout channels	Reference command response time (ms)
1	80
10	99
50	183

Note:

- The above shows the reference command response times when the data type is INT16. If the data type is INT32 or FLOAT, double the values shown above.
- If communication is performed via repeaters, add a 80 ms delay for each hop.
- If UPM is a router, add a margin of 750 ms.

A calculation example of the data acquisition interval is shown below.

Examples 1 to 3 are when GM 10 is a router. Example 4 is when UPM 100 is a router.

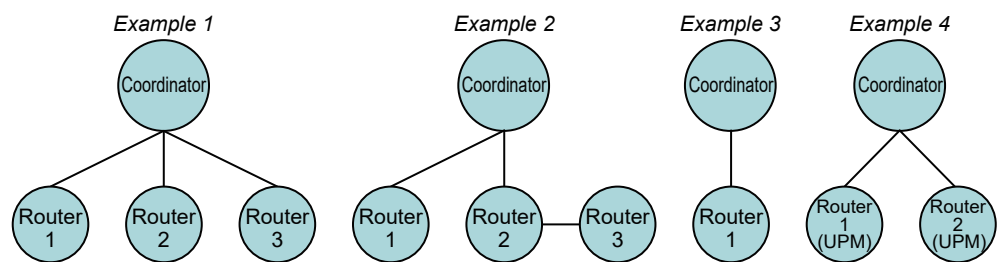

Fig. 5.12 A calculation example of the data acquisition interval

Example 1

If data is acquired from three routers (router 1, 2, and 3) and the number of channels of each router is 10, 20, and 40, respectively, the data acquisition interval is given by

$$\text{Data acquisition interval} = 220 + 230 + 250 = 700 \text{ (ms)}$$

Therefore, data acquisition is possible at a read cycle of 1 s or more.

Example 2

If data is acquired from three routers (router 1, 2, and 3), the number of channels of each router is 10, 20, and 40, respectively, and router 2 is used as a repeater for router 3, the data acquisition interval is given by adding an 80 ms delay per hop as follows:

$$\text{Data acquisition interval} = 220 + 230 + 250 + 80 = 780 \text{ (ms)}$$

Therefore, data acquisition is possible at a read cycle of 1 s or more.

Example 3

If data is acquired from router 1 and the number of channels is 200, because a command for 125 channels and another for 75 channels are sent to a single router, the data acquisition interval is given by

Data acquisition interval = $335+290 = 625$ (ms)

Therefore, data acquisition is possible at a read cycle of 1 s or more.

Example 4

If FLOAT data is acquired from 2 routers (routers 1 and 2) by using 3 commands (2 commands for router 1 where the first reads 1 register and the other reads 10 registers, plus 1 command for router 2 that reads 10 registers), and maintaining a margin of 750 ms, the data acquisition interval is $160+198+198+750=1306$ (ms).

Therefore, data acquisition occurs at a communication interval of 2 sec or more.

If data is acquired by using the GM10 with the /WH option (integration bar graph function) as the coordinator and the UPM100 as the router, determine the communication interval by referring to the table below.

Number of connected UPMs per GM unit	Recommended Modbus interval
1	2 seconds or more
2	2 seconds or more
3 to 5	5 seconds or more
6 to 10	10 seconds or more
11 to 20	20 seconds or more
21 to 30	30 seconds or more
31 or more	1 minute

* The recommended values for the communication interval when reading out active energy (register 40001), active power (register 40007)/voltage1-3/current 1-3/power factor (register 400021), and frequency (register 40075) from each UPM100 using 3 commands.

App 5.4.6 Transmitter Output

You can change the radio traveling distance by changing the radio transmitter output.

The US wireless device provides three transmitter output levels, 20 mW, 1 mW, and 0.16 mW, that you can choose from. The Korea wireless device provides four transmitter output levels, 12.5 mW, 5 mW, 1 mW and 0.16 mW, that you can choose from.

Table 5.10 Transmitter output

Target	Configuration	Parameter specification and range	Notes
Parent	Mandatory	20mW/1mW/0.16mW	
Router	Mandatory	20mW/1mW/0.16mW	

In this configuration example, we set the transmitter output to 20 mW.

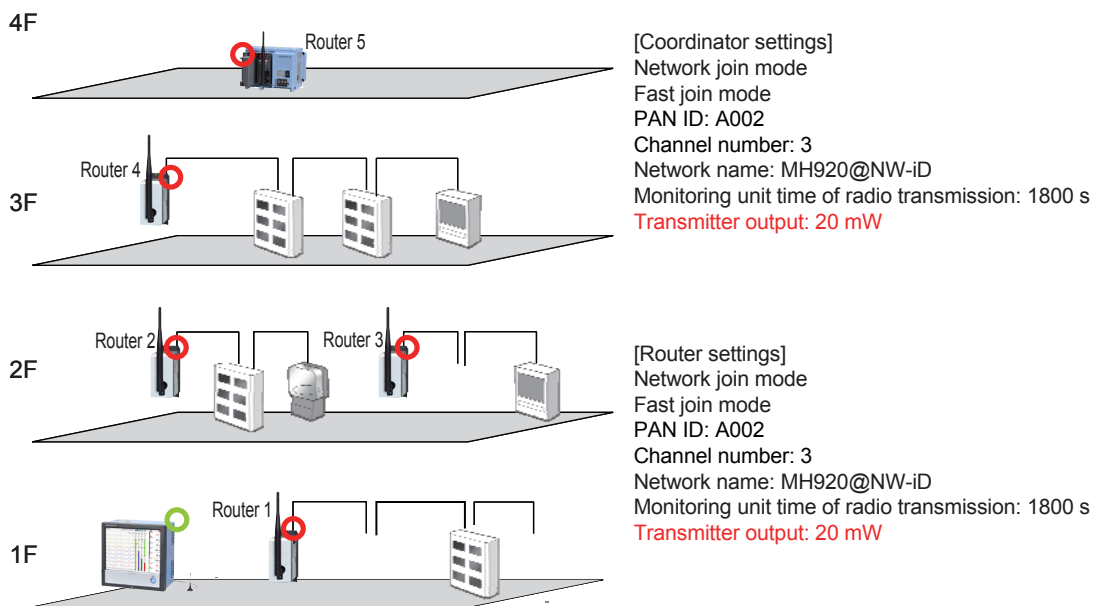

Fig. 5.13 Transmitter output setting in the configuration example

App 5.4.7 Retry Times before Route Switching

The wireless device allows you to select whether to change the route to another one when communication fails several times using the same route when a coordinator tries to communicate with repeaters and routers through a given communication route (hereafter referred to as the downward route). This retry count is called "retry times before route switching."

The wireless device allows you to select the retry times before route switching from three levels (1, 2, and 3). If you set retry times before route switching to 1, the time it takes to make a switch when a communication error occurs can be reduced, and a communication route with good connection conditions is selected. However, route switching will occur even if a communication error occurs due to a temporary radio fluctuation causing a route that is normally in condition to be changed. Taking this into consideration, the default value of 3 provides a good balance between the frequency of route switching and communication reliability.

Table 5.11 Retry times before route switching

Target	Configuration	Parameter specification and range	Notes
Parent	Mandatory	1/2/3	
Router	Mandatory	1/2/3	

In this configuration example, retry times before route switching will be set to 3 on the coordinator, repeaters, and routers.

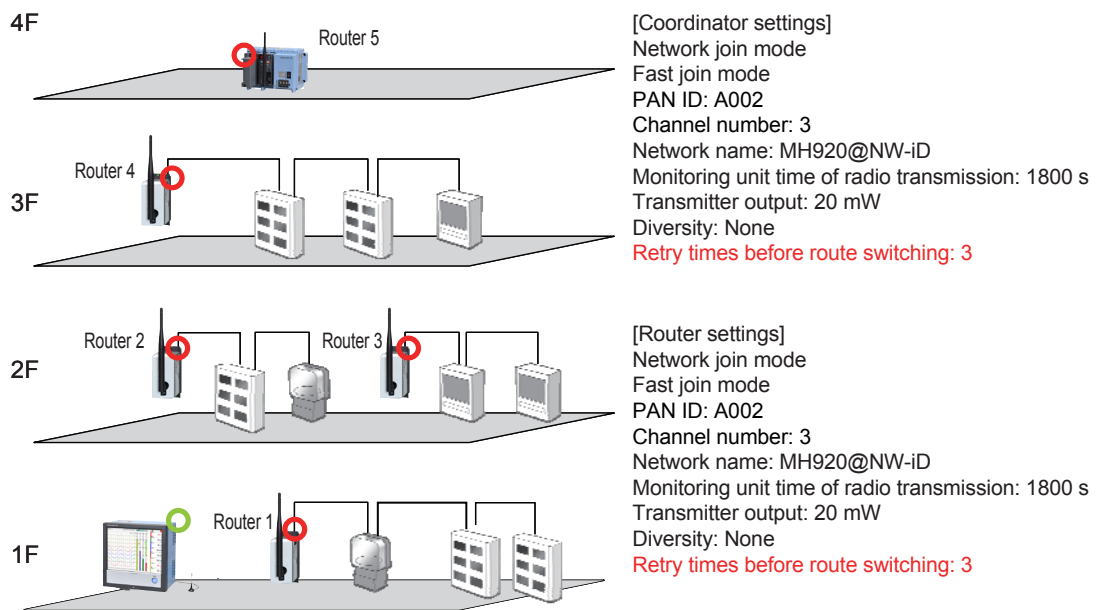

Fig. 5.14 Number of communication failures before switching the downward route

App 5.4.8 Security Design

For a wireless device to join a wireless multi-hop network, network join authentication must be performed from the routers to the coordinator. The wireless device provides the following two methods for authentication.

- (1) Network join authentication using encryption keys
- (2) Network join authentication using MAC addresses

In addition, the following method can be used to refuse specific routers from joining the network.

- (3) Network join refusal using MAC addresses

On wireless device, the registration of network join authentication using encryption keys is a must. Network join authentication using MAC addresses is optional. You can increase the security level using both methods together.

(1) Network join authentication using encryption keys

Similar to Wi-Fi and other wireless networks, wireless multi-hop networks use the AES encryption algorithm to perform encrypted wireless communication. When joining a network, a wireless device must receive from the coordinator a genuine network encryption key needed to perform encryption and decryption. To receive this key, you need to register a encryption key in the wireless device in advance.

Fig. 5.15 is a flowchart showing the key exchange that occurs during network join authentication.

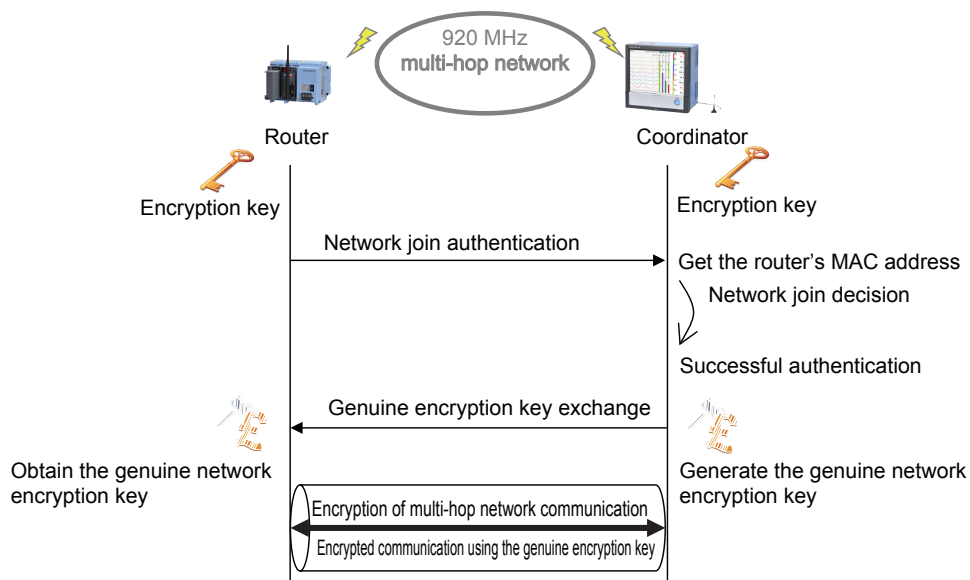

Fig. 5.15 Key exchange during network join authentication

To use a wireless device, set the encryption key using a 32-digit hexadecimal value. When only network join authentication using encryption keys is used, the encryption key is used for data communication over the network in addition to during the network join authentication of routers. As such, set the encryption key on routers the same as that on the coordinator.

Assign an encryption key to wireless devices according to the specifications in Table 5.12.

Table 5.12 Encryption key

Target	Configuration	Parameter specification and range	Notes
Parent	Mandatory	32 digit hexadecimal	
Router	Mandatory	32 digit hexadecimal	Use the same value as that assigned to the coordinator.

(2) Network join authentication using MAC addresses

To perform network join authentication using MAC addresses, you need to register in the coordinator the MAC addresses of wireless devices that will be allowed to join the network in advance.

Using network join authentication using MAC addresses allows wireless devices of malicious third parties to be rejected from joining the network.

If network join authentication using MAC addresses is used, it will be possible to assign different encryption keys to each router. The maximum number of MAC addresses that can be registered is 200.

MAC addresses are indicated on the nameplate of each wireless device. The addresses are specified by delimiting each address with a colon.

Set the MAC address authentication in the coordinator by following the specifications in Table 5.13.

Appendix 5 System Operation Considerations

Table 5.13 MAC address authentication

Target	Configuration	Parameter specification and range	Notes
Parent	Mandatory	On/Off	

In this configuration example, only the network join authentication using encryption keys will be used. A common encryption key will be set in the coordinator and routers.

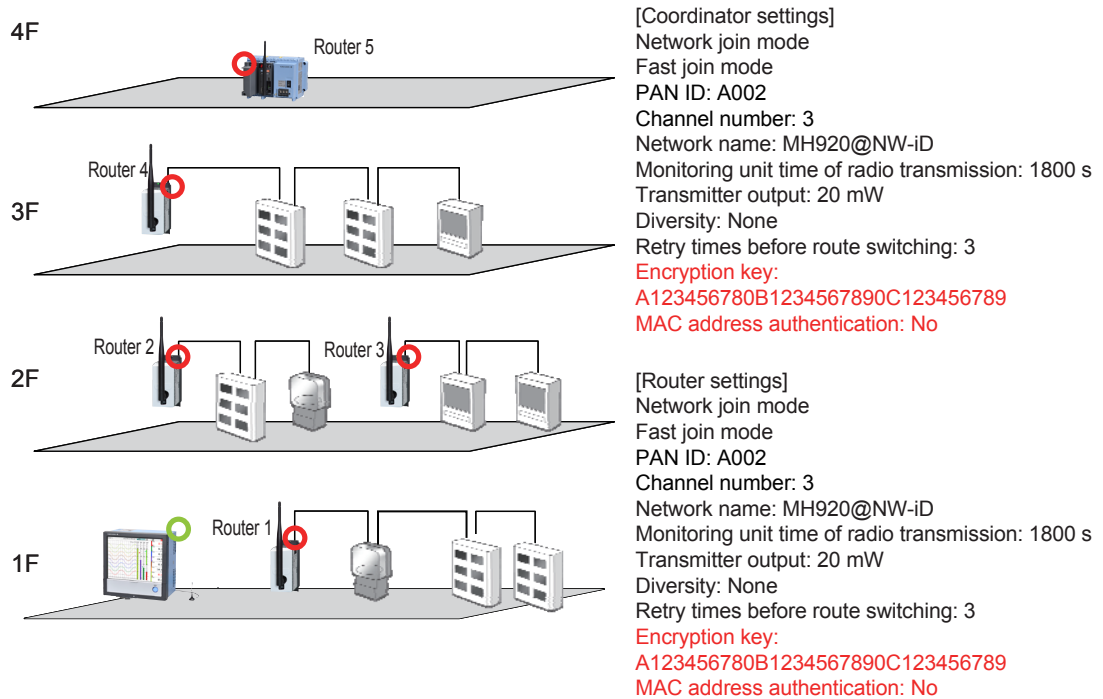

Fig. 5.16 Security settings in the configuration example

(3) Network join refusal using MAC addresses

In the event of spoofing using false MAC addresses, abuse of stolen wireless devices, or other foreseeable malicious attacks from third parties, wireless devices whose MAC addresses are registered in the refuse list will be rejected from joining the network. However, if you want to remove a wireless device that is already connected to the network, that device must be disconnected first, such as by restarting the wireless coordinator that is in charge of the network.

App 5.4.9 IPv6 Prefix

When a wireless device passes the network join authentication and is officially permitted to join the multi-hop network, the device obtains an IPv6 address before joining the network. Fixed prefix information (the upper 64 bits) that is used to generate this IPv6 address is set in the wireless coordinator. IPv6 addresses that are used by wireless devices are automatically assigned using this fixed prefix information set in the coordinator and the short addresses assigned to each coordinator and router. IPv6 addresses are assigned according to the following steps.

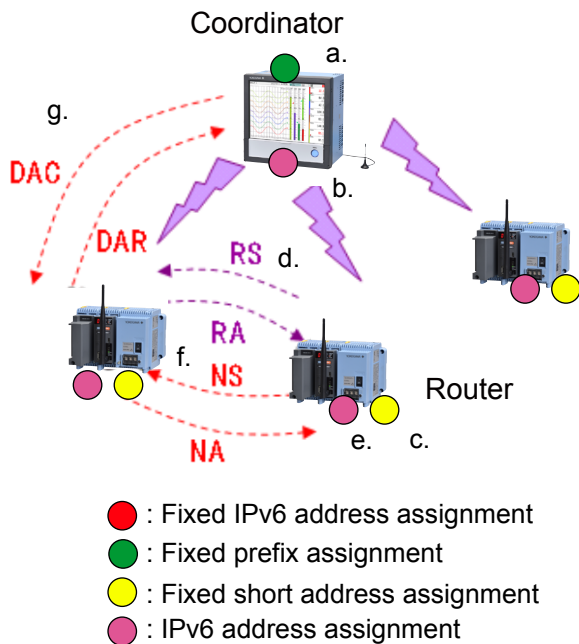

- a. Using the maintenance console, set the fixed prefix information in the coordinator.
- b. The coordinator uses the specified fixed prefix to automatically assign its own IPv6 address. (The coordinator's short address is fixed to 0.)
- c. Using the maintenance console, assign a fixed short address to the router.
- d. The router exchanges RS/RA with the adjacent wireless device to obtain prefix information.
- e. The router uses the prefix information and the assigned short address to automatically assign its own IPv6 address.
- f. The router sends the assigned IPv6 address to the coordinator through NS.
- f. The coordinator exchanges DAR/DAC, determines whether to allow the notified IPv6 address, and notifies the router of the result through NA. From this point, the coordinator handles the notified IPv6 address as an address under its control.

Fig. 5.17 IPv6 address assignment

For the fixed prefix information set in the coordinator, specify the IPv6 global unicast address (an address whose first 16 bits are defined in the range of 2000 to 3FFF as shown in Fig. 5.18). You cannot omit consecutive zeros using two consecutive colons, which is a typical method of specifying IPv6 addresses.

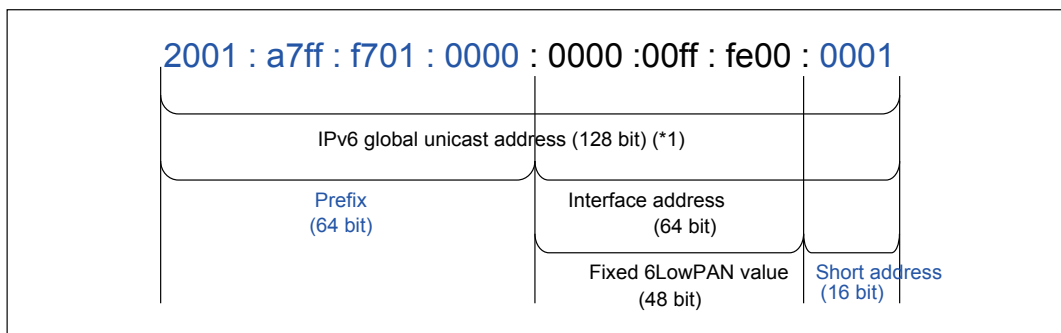

Fig. 5.18 IPv6 address structure

Appendix 5 System Operation Considerations

If wireless devices are used in a transparent model, prefix information can be set to any value because IPv6 communication takes place in a closed wireless network. However, we recommend that different prefix information be set for each coordinator in terms of network management.

Select the prefix information from the values in Table 5.14.

Table 5.14 Prefix information

Target	Configuration	Parameter specification and range	Notes
Parent	Mandatory	Upper 64 bits of the IPv6 global unicast address	Omission using two colons cannot be used.

In this configuration example, we set the fixed prefix information to the values shown in Fig. 5.19.

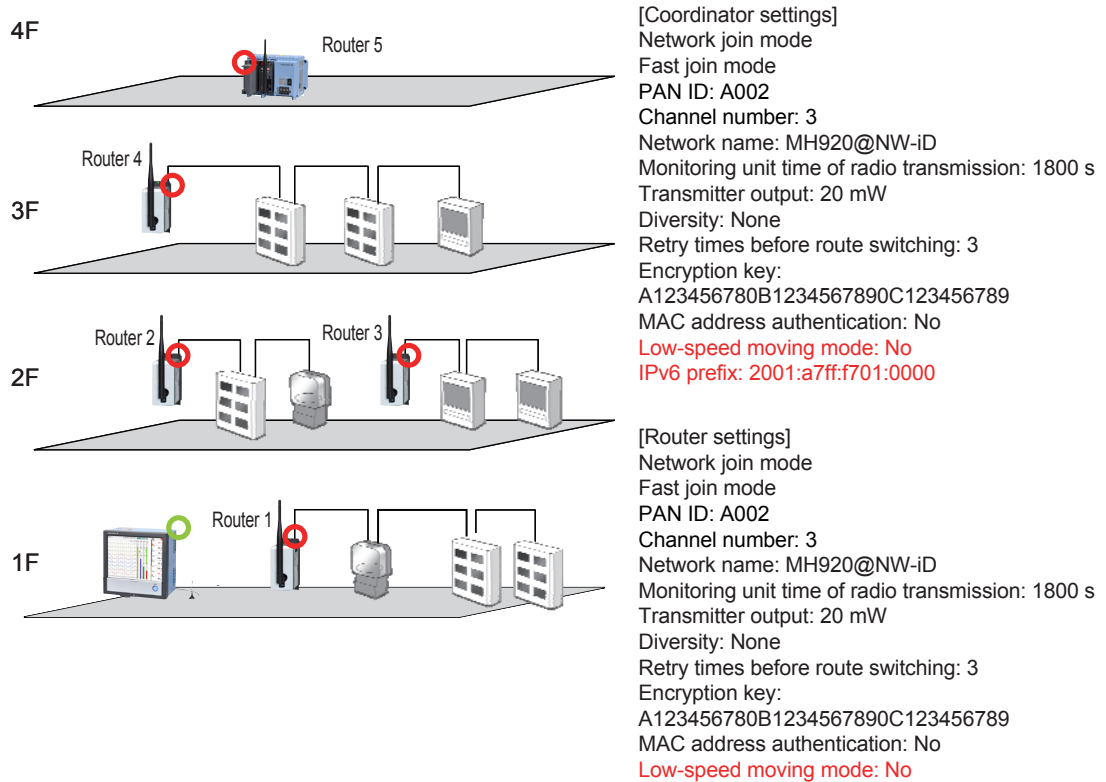

Fig 5.19 IPv6 prefix assignment in the configuration example

App 5.4.10 Station Numbers and Short Addresses

There are three modes to collect information from sensors connected to wireless devices. Two of the modes involve mapping the short addresses assigned to wireless routers with to station numbers assigned to sensors on the wireless coordinator. The third mode collects information without using station number analysis.

- (1) List mode
- (2) Range mode
- (3) No station number analysis mode

The following flowchart shows the mapping of station numbers to wireless devices' short addresses.

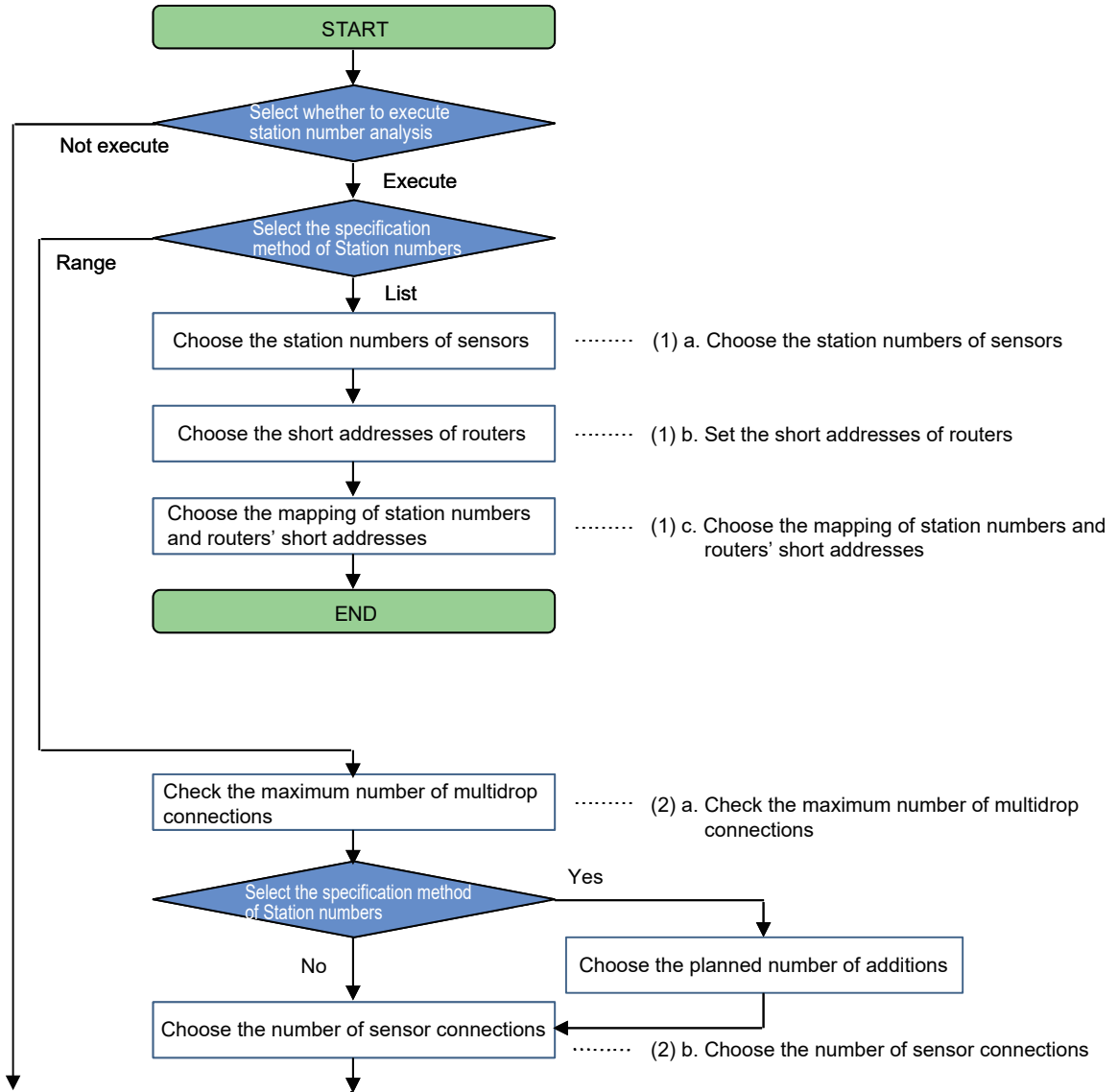

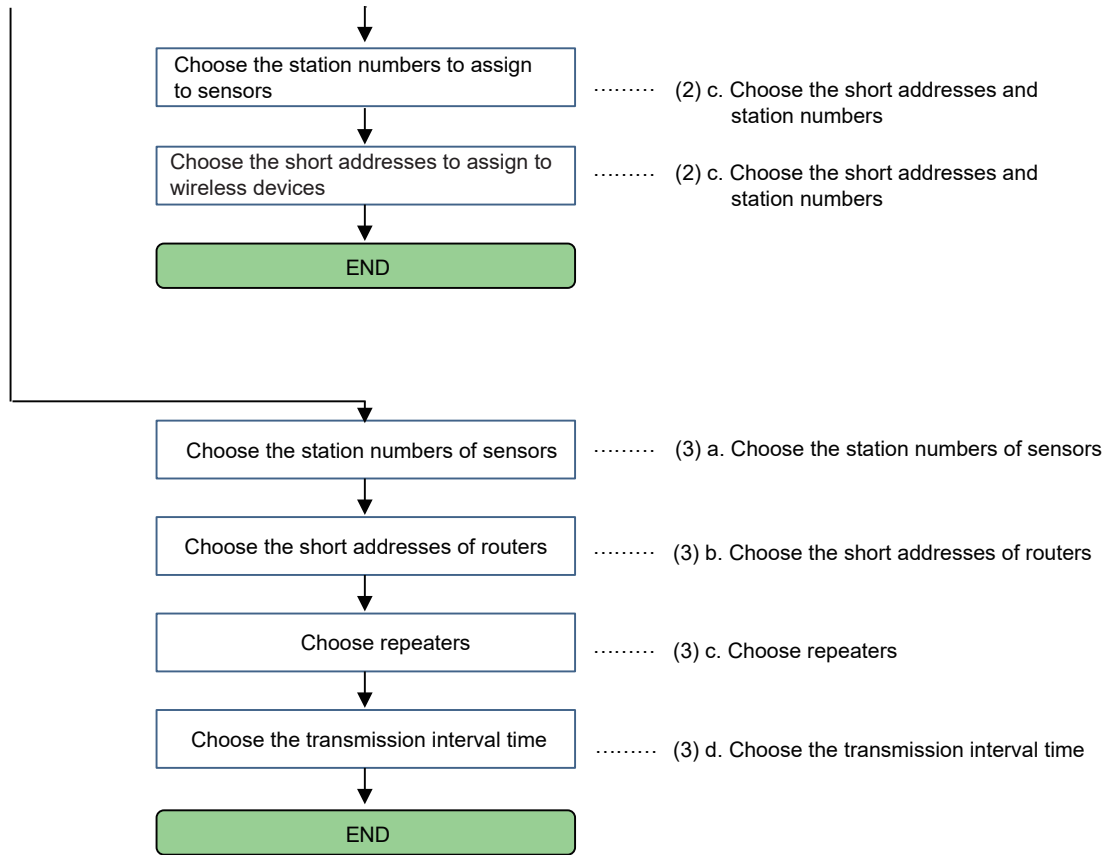

Fig. 5.20 Flowchart for choosing station numbers and routers' short addresses

(1) List mode

In list mode, the pairs of sensors' station numbers and wireless devices' short addresses are registered in the station number list of the coordinator.

The values in list mode are chosen according to steps a to c below.

a. Choose the station numbers of sensors

Choose station numbers of your choice to assign to sensors connected to routers. When connecting several sensors, assign unique station numbers to each.

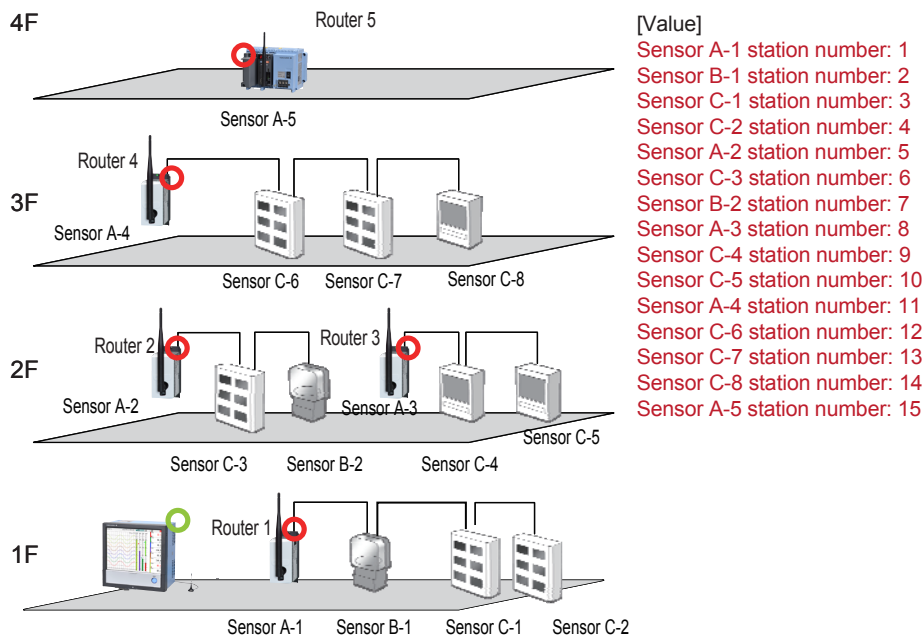

Fig. 5.21 Choosing station numbers in the configuration example

b. Choose the short addresses of routers

Assign short addresses to wireless coordinators and routers. The short addresses to assign to wireless coordinators are fixed to 0000.

The short addresses to assign to wireless routers are chosen from 4 digit values ranging from 0001 to FFFD in hexadecimal notation. The addresses must be unique to each router and sensor in the wireless network, regardless of whether there are sensors belonging to routers.

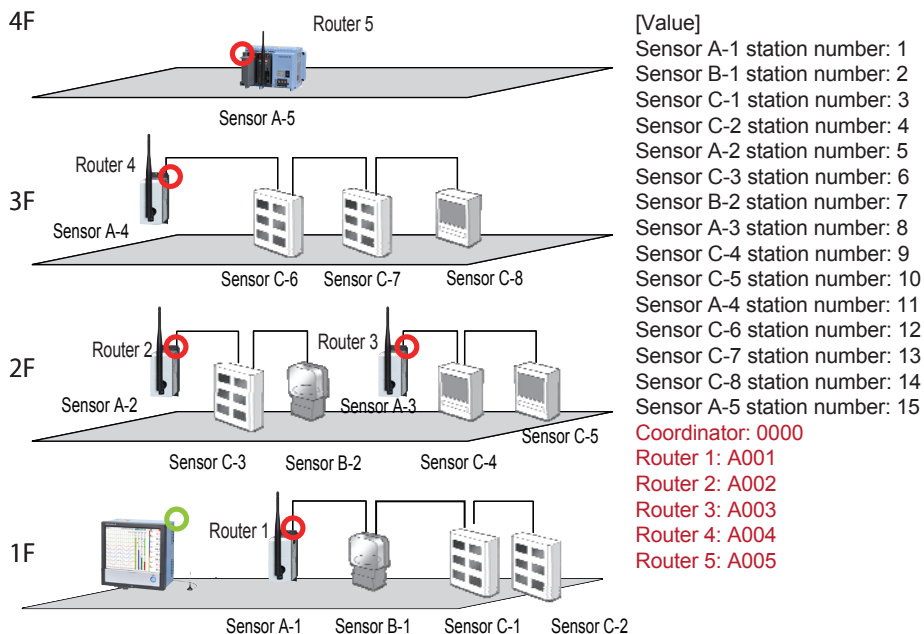

Fig. 5.22 Choosing the short addresses of routers in the configuration example

c. Choosing the mapping of station numbers and routers' short addresses

Choose pairs of routers' short addresses and station numbers of devices connected to the routers to register in the coordinator's station number list.

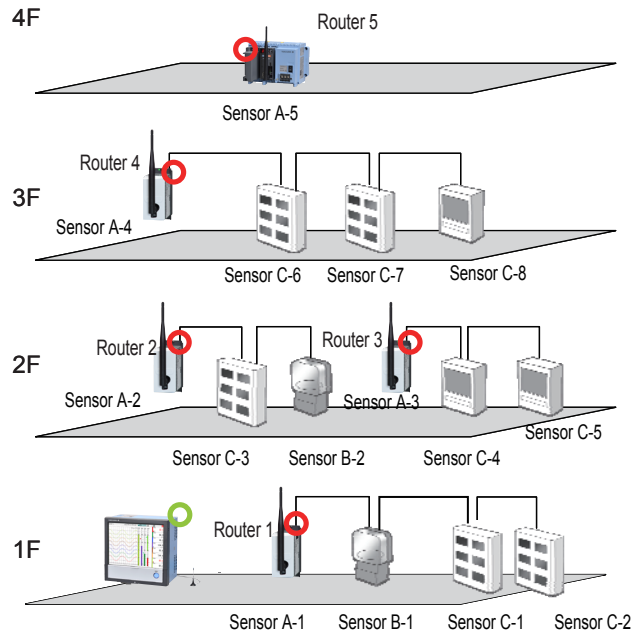

Fig. 5.23 Model configuration for choosing station numbers and routers' short addresses

(2) Range mode

In range mode, station numbers of sensors and short addresses of routers are chosen from a given range of values based on the maximum number of sensors that are connected to a single wireless router.

The values in range mode are chosen according to steps a to c below.

a. Check the maximum number of multidrop connections

First, the number of sensors to connect to the wireless coordinator is chosen based on the maximum number of sensors that are connected in a multidrop configuration in the same network. The applicable sensors here are those other than those connected in a multidrop configuration to data acquisition devices and wireless coordinators.

The number of sensors to connect can be chosen from any of the available options (1/1 to 4/1 to 8/1 to 16/1 to 31) as long as the number is greater than the maximum number of sensors connected in a multidrop configuration.

Select the maximum number of multidrops from the values in Table 5.16.

Table 5.16 Maximum number of multidrops

Target	Configuration	Parameter specification and range	Notes
Parent	Mandatory	Maximum number of multidrops 1, Maximum number of multidrops 1 to 4, Maximum number of multidrops 1 to 8, Maximum number of multidrops 1 to 16, Maximum number of multidrops 1 to 31	

App

Appendix

In the model configuration under consideration, the maximum number of multidrop connections is 3, which is the number of connections to router 1 and router 4.

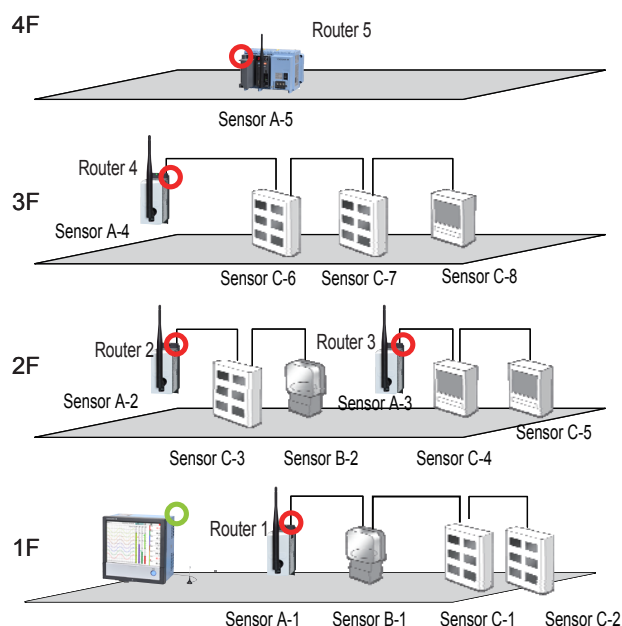

Table 5.25 Model configuration for checking the maximum number of multidrops

b. Choose the number of sensor connections

The range of station numbers that can be assigned to sensors connected to wireless routers are determined from the number of sensors to connect to the wireless coordinator.

Tables 5.17 to 5.19 show examples of range of station numbers that can be assigned according to the number of sensor connections.

In the model configuration under consideration, we confirmed that the maximum number of multidrops is 3 in step a. As such, here we use a range for 4 units or more. If there are plans to increase the number of sensors connected in a multidrop configuration in the future, choose a number with enough margin for expansion.

In the model configuration under consideration, we set the number of sensor connections to 4, assuming that there will be no additions in the future.

Table 5.17 Assignable range of station numbers

Coordinator short address	Assignable range of station numbers				
	Number of sensor connections				
	1 (unit)	4 (units)	8 (units)	16 (units)	31 (units)
0001	1	1 or 4	1 or 8	1 or 16	1 or 31
0002	2	5 to 8	9 to 16	17 to 32	32 to 62
0003	3	9 to 12	17 to 24	33 to 48	63 to 93
0004	4	13 to 16	25 to 32	49 to 64	94 to 124
0005	5	17 to 20	33 to 40	65 to 80	125 to 155
0006	6	21 to 24	41 to 48	81 to 96	156 to 186
0007	7	25 to 28	49 to 56	97 to 112	187 to 217
0008	8	29 to 32	57 to 64	113 to 128	218 to 248
0009	9	33 to 36	65 to 72	129 to 144	249 to 279
000A	10	37 to 40	73 to 80	145 to 160	280 to 310

c. Choosing the short addresses and station numbers

Assign short addresses to wireless coordinators and routers. The short addresses to assign to wireless coordinators are fixed to 0 (0x0000).

The short addresses are assigned to wireless routers after choosing the short addresses to assign to the routers and the station numbers to assign to connected sensors based on the assignable range of station numbers selected in step b, "Choose the number of sensor connections." For each of the coordinators (repeaters) that sensors will not be connected to, however, can be assigned a unique address in the range of 4096 (0x1000) to 65533 (0xFFFFC) because station numbers do not need to be considered.

The steps to assign short addresses based on station numbers are explained using the model configuration shown in Fig. 5.26 as an example.

First, check the station numbers that will be assigned to sensors connected to devices other than routers. In the configuration shown in Fig. 5.26, sensors connected to devices other than routers are those that are connected to the data acquisition device in a multidrop configuration along with the coordinator.

As such, we assign short addresses 2 (0x0002) to 6 (0x0006) to coordinators 1 to 5, respectively. Then, we assign the station numbers that can be assigned for each short address to the sensors connected to each router, as shown in Fig. 5.26.

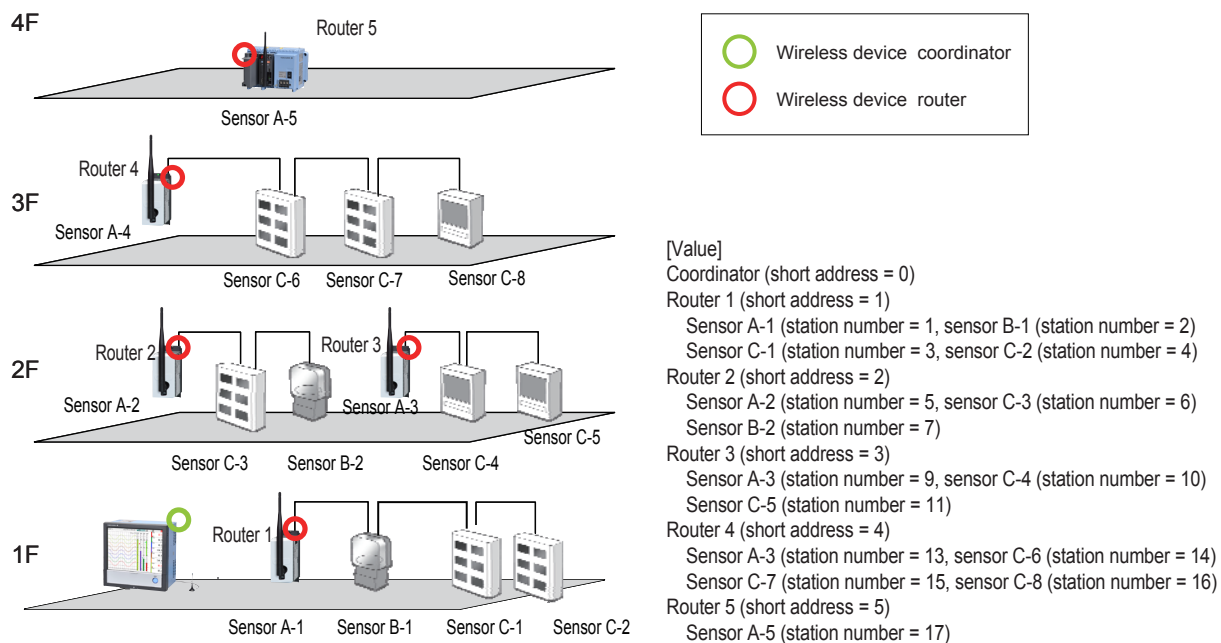

Fig. 5.26 Model configuration for choosing short addresses and station numbers

Table 5.18 Assignable range of station numbers (extract)

Coordinator short address	Assignable range of station numbers
	Number of sensor connections
	4 (units)
0001	1 to 4
0002	5 to 8
0003	9 to 12
0004	13 to 16
0005	17 to 20
0006	21 to 24
0007	25 to 28
0008	29 to 32
0009	33 to 36
000A	37 to 40

(3) No station number analysis mode

If the wireless coordinator is set to no station number analysis, data from the host device will be sent to all routers without analyzing the station numbers. Even in systems that use the RS-485 protocol with a format that does not allow station number analysis, serial communication can easily be converted into wireless communication in a transparent model configuration.

In this mode, if Station number analysis is set to No, the coordinator sends commands to all routers in the network, excluding dedicated repeaters (which have terminal connections disabled) and waits for the responses from relevant routers. With this method, the coordinator does not need to manage the mapping of short address station numbers of routers.

However, because commands are sent to all routers, it takes longer for the host device to receive a response when compared to a system that uses station number analysis. As a guideline, the number of units, the data size, and the frequency of communication should be no greater than those shown in the following configuration example.

Number of routers: 25

Transmission data size: 256 bytes

Command transmission interval from the host device (e.g., data acquisition device): 10 s or more

(With the above configuration example, communication is possible within the radio signal transmission time limit.

Station number

Station number position after the start character code

= Range you want to offset (2 bytes)

The values in no station number analysis mode are chosen according to steps a to c below.

a. Choose the station numbers of sensors

Choose station numbers of your choice to assign to sensors connected to routers. When connecting several sensors, assign unique station numbers to each.

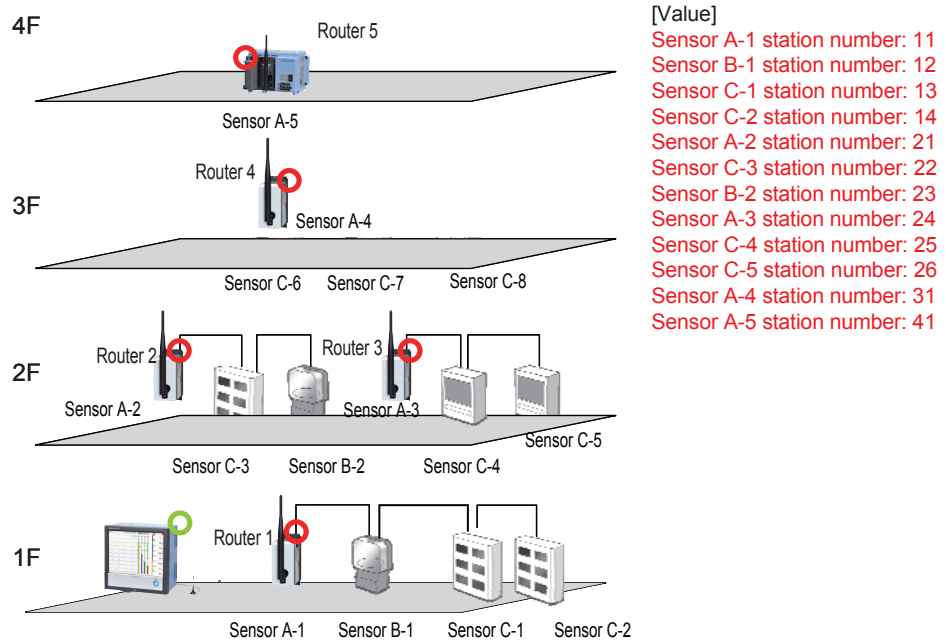

Fig. 5.28 Choosing station numbers in the configuration example

b. Choose the short addresses of routers

Assign short addresses to wireless coordinators and routers. The short addresses to assign to wireless coordinators are fixed to 0000.

The short addresses to assign to wireless routers are chosen from 4 digit values ranging from 0001 to FFFD in hexadecimal notation. The addresses must be unique to each router in the wireless network, regardless of whether there are sensors belonging to routers.

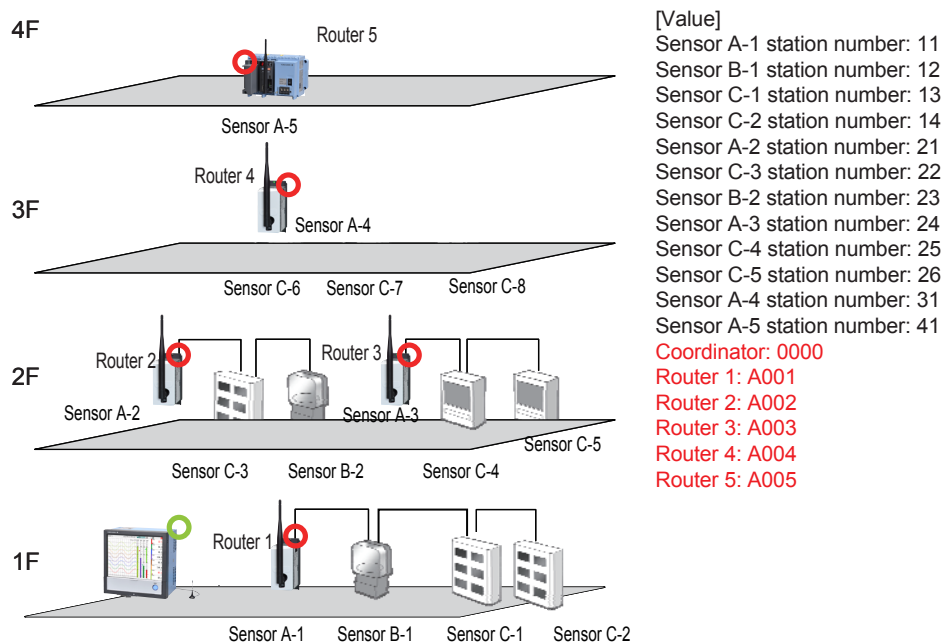

Fig. 5.29 Choosing the short addresses of routers in the configuration example

c. Choose repeaters

For Routers used as repeaters (routers without sensors, e.g., coordinator 4 in Fig. 5.30), disabling the Equipment Connection setting causes the coordinator to no longer send commands to those routers. This reduces network traffic and response time.

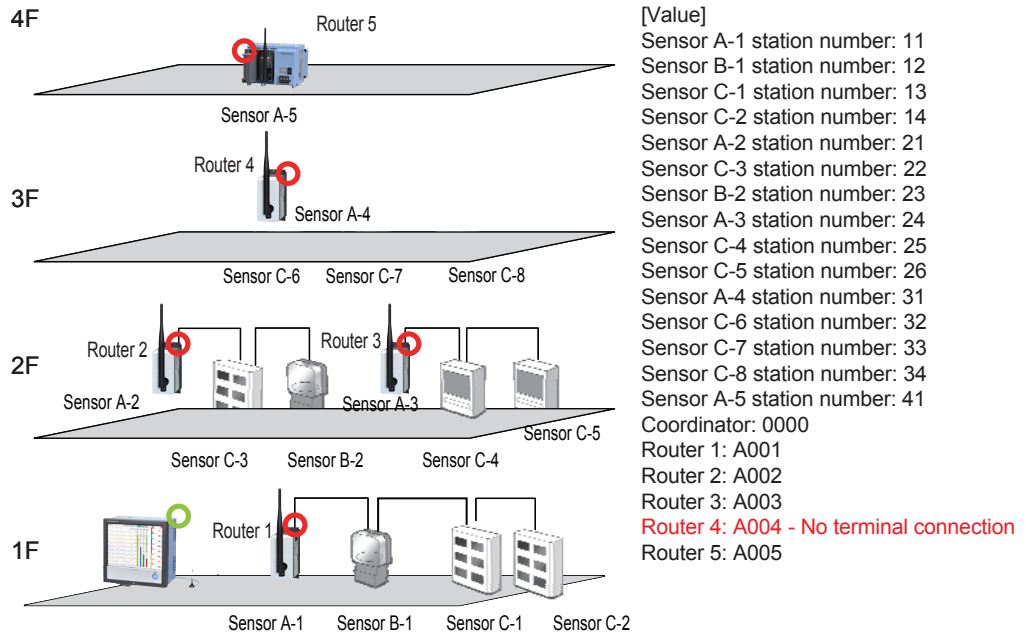

Fig. 5.30 Choosing repeaters in the configuration example

d. Choose the data transmission interval when transmitting to all the child devices

When no station number analysis mode is used, data transmission interval when transmitting to all the child devices can be changed on wireless devices. Note that there will be some deviation between the specified data transmission interval when transmitting to all the child devices and the actual transmission interval over wireless. Also, depending on the data size, data may be transmitted at intervals longer than the data transmission interval when transmitting to all the child devices over wireless segments.

Data transmission interval when transmitting to all the child devices can be set in the range shown in Table 5.20 in units of 100 ms.

Table 5.20 Data transmission interval when transmitting to all the child devices

Target	Configuration	Parameter specification and range	Notes
Parent	Mandatory	100 ms to 5000 ms	The default value is 300 ms.

App 5.4.11 Reviewing Packet Filtering Setup

Packet filtering is used to discard duplicate data packets that are received by the host device, such as those received as a result of retransmission from sensors. There are two types of packet filtering depending on the method used by the host device to acquire data, namely polling and notification. Polling refers to a method in which a host device sends a command to a specific sensor connected to a router, and the sensor returns a unique response to the host device. If polling is specified, it is possible to discard delay and duplicated packets sent from wireless coordinators to routers and from routers to coordinators in the wireless network. In contrast, notification type refers to a method in which data is transmitted at will from the host device or sensors. With the notification type, it is possible to discard duplicated packets sent from wireless coordinators to routers or from routers to coordinators in the wireless network.

Table 5.21 Packet filtering settings

Target		Parameter	Parameter specification and range	Notes
Parent	Router			
R	R	Packet filtering (*1)	No, Yes (notification type), Yes (polling type)	Set the packet filtering function to None, Yes (notification type), or Yes (polling type). If set to Yes (polling type), delayed packets and the like are discarded according to filter timeouts that occur during polling (coordinator to router to coordinator). If set to Yes (notification type), delayed packets and the like in the data transmission in one direction (coordinator to router or router to coordinator) are discarded.
R	—	Filter timeout on polling (Coordinator)	10 to 600 (in units of 100 ms)	When packet filtering is set to Yes (polling type), set the timeout value to a value obtained by subtracting the fixed overhead (1 second) from the filter timeout on polling of the host device (e.g., data acquisition device). Default value: 40 (in units of 100 ms)
—	R	Filter timeout on polling (Router) (*2)	0,10 to 600 (in units of 100 ms)	When packet filtering is set to Yes (polling type), set a value no less than the polling response time of the connected sensors. Default value: 10 (in units of 100 ms) ("0" is allowed only when no station number analysis mode is selected.)

R: Configuration required

—: Configuration not possible

*1: Set the packet filtering to the same value (No, Yes (notification type), or Yes (polling type)) for all wireless devices in the same network.

*2: If you want to set Packet filtering to Yes (polling type) in no station number analysis mode, set Filter timeout on polling of routers to 0.

App 5.4.12 Reviewing Fixed Route Setup

As explained in section 5.4.2, “PAN ID (group number),” a wireless device tries to connect to the device with the best RSSI value among the received radio signals if the PAN-ID is the same when joining the network.

The fixed route function can be used to connect wireless devices to specific connection destinations, regardless of the RSSI values. If temporary detour is enabled along with this function, data is transmitted through a detour route if the radio signal conditions with the fixed connection destination is poor.

For the fixed connection destination, specify a wireless device that is one hop ahead in the upward (coordinator) direction. The route toward the downward (router) direction is automatically calculated in the same manner as during automatic route configuration.

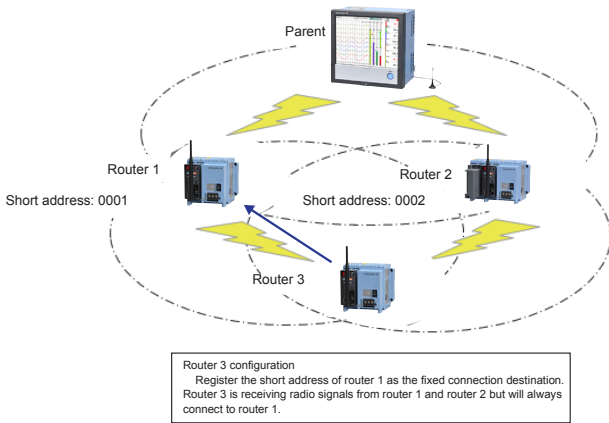

Fig. 5.31 Fixing the connection destination using fixed route

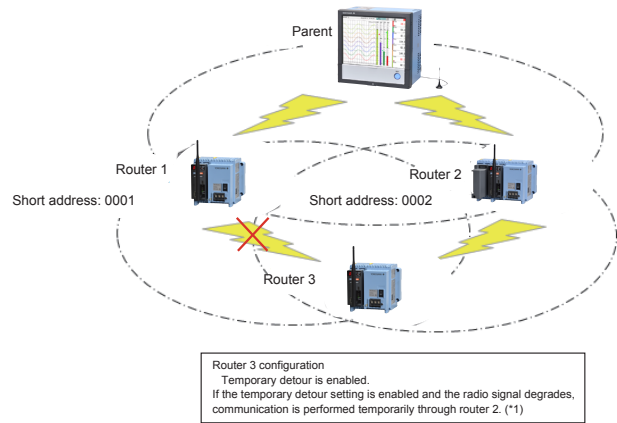

Fig. 5.32 Changing the transmission destination using the temporary detour setting

Table 5.22 Fixed route setup

Target		Parameter	Parameter specification and range	Notes
Parent	Router			
—	R	Fixed route	Yes, No	Enables or disables fixed route.
—	R	Destination short address	0000 to FFFD	Short address of the fixed connection destination
—	D	Temporary detour	Yes, No	When the fixed route function is enabled, you can enable or disable detour transmission. (*2)

R: Configuration required, D: Default values can be used.

*1: If data transmission to the fixed connection destination (router 1) of router 3 fails, detour transmission is made through a different route if available (router 2 in this example). If this detour occurs three times, the route is changed to router 2 even if fixed route is enabled. Then, if the route to router 1 is reestablished, the route returns to the registered route (several tens of seconds to several minutes).

*2: When joining a network, if the radio signal of the fixed connection destination cannot be received, joining the network is not possible even if the temporary detour setting is enabled.

App 5.4.13 Network Scale Setup and Network Quality Setup

Optimize the control signal transmission frequency for maintaining the wireless network according to the number of wireless devices connected to the same network.

Be sure to set the same network scale for wireless devices with the same PAN ID (group number). The default value is for 1 to 30 units. Change this value to an appropriate value when configuring the system. If this value is in conflict with the network scale, errors such as data omission and disconnection and problems such as needing a long time to detect disconnections may occur.

In network quality setup, if frequency of route switching and delay is set to the highest setting, packet reachability increases as compared to the standard setting. However, because the frequency of retransmission is increased to improve reachability, there is a tendency for the data arrival time (delay) to become longer. To strike a balance between the data arrival time and delay, use the standard setting. If reachability is more important, specify Frequency of route switching and delay (highest).

Table 5.23 Network scale setup parameters

Target		Parameter	Parameter specification and range	Notes
Parent	Router			
R	R	Use child device for low-speed moving mode	—	Clear the check box.
R	R	Device type in a network	Child (fixed), Child (fixed) + wireless sensor,	Select Child (fixed) or Child (fixed) + Child (fixed) + wireless sensor. The default value is Child (fixed).
R	R	Number of devices in a network	1 to 30 devices 31 to 60 devices 61 to 100 devices	Select 1 to 30 devices, 31 to 60 devices, or 61 to 100 devices. The default value is 1 to 30 devices.
R	R	Number of child devices and wireless sensors in a network	Child device only (up to 25 child devices) Standard (15 child devices and 10 sensors), Maximum number of wireless sensors (5 Child devices and 20 sensors)	Select Child device only (up to 25 devices), Standard (15 child devices and 10 sensors), or Maximum number of wireless sensors (5 Child devices and 20 sensors). The default value is Standard.
R	R	Set network quality	Standard (recommended), Frequency of route switching and delay (higher), Frequency of route switching and delay (highest)	Select Standard (recommended), Frequency of route switching and delay (higher), or Frequency of route switching and delay (highest).

R: Configuration required

App 5.4.14 Password for Connecting to the Wireless Device

You can change the login password for connecting to wireless devices from the maintenance console.

It is assumed that using the default password is not desirable in terms of security. Therefore, we recommend you change the wireless device password using this function. Table 5.24 shows the password specifications. If you change the password, also change the environment setup of the maintenance console.

Table 5.24 Login password

Target	Configuration	Parameter specification and range	Notes
Parent	Mandatory	5 to 8 alphanumeric characters	The password is case-sensitive.
Router	Mandatory	5 to 8 alphanumeric characters	The password is case-sensitive.