**User's
Manual**

SMARTDAC+[™]

**Data Acquisition System GM
User's Manual**

Introduction

Thank you for purchasing the SMARTDAC+ GM Data Acquisition System (hereafter referred to as the GM).

This manual explains how to use the GM. In this manual, the GM10 standard type and large memory type are distinguished using the following notations.

- **Standard type: GM10-1**
- **Large memory type: GM10-2**

For details on the settings and operation of the PID control module and program control (/PG option), see the Loop Control Function, Program Control Function (/PG Option) User's Manual (IM 04L51B01-31EN), provided as an electronic manual.

For details on installation, wiring, configuration, and PROFINET communication of the network module (GX90NW-02-PN), see the PROFINET Communication User's Manual (IM 04L51B01-22EN) provided as electronic manuals.

For details on other options, see the relevant user's manuals.

To ensure correct use, please read this manual thoroughly before beginning operation.

The following manuals are provided for the GM.

• Paper Manuals

Manual Title	Manual No.	Description
Data Acquisition System GM First Step Guide	IM 04L55B01-02EN	Explains the basic operations of the GM.
Precaution on the use of SMARTDAC+	IM 04L51B01-91EN	Provides precautions common to the SMARTDAC+ series.
Regarding the Downloading and Installing for the Software, Manuals and Labels About the Usage of Open Source Software	IM 04L61B01-11EN	Explains where software applications and electronic manuals common to the SMARTDAC+ series can be downloaded from and how to install the software applications.

• Downloadable Electronic Manuals

You can download the latest manuals from the following website.

www.smartdacplus.com/manual/en/

Manual Title	Manual No.	Description
Data Acquisition System GM First Step Guide	IM 04L55B01-02EN	This is the electronic version of the paper manual.
Data Acquisition System GM User's Manual	IM 04L55B01-01EN	Describes how to use the GM. The communication control commands and some of the options are excluded.
Models GX10/GX20/GP10/GP20/GM10 Communication Command User's Manual	IM 04L51B01-17EN	Describes how to use command control communication functions.
SMARTDAC+ STANDARD Universal Viewer User's Manual	IM 04L61B01-01EN	Describes how to use Universal Viewer, which is a software that displays GM measurement data files.
SMARTDAC+ STANDARD Hardware Configurator User's Manual	IM 04L61B01-02EN	Describes how to use the PC software for creating setting parameters for various GM functions.
SMARTDAC+ STANDARD IP Address Configurator User's Manual	IM 04L61B01-03EN	Describes how to use the software for setting the GM IP address.
Models GX10/GX20/GP10/GP20/GM10 Multi-batch Function (/BT) User's Manual	IM 04L51B01-03EN	Describes how to use the multi batch function (/BT option).
Data Acquisition System GM Advanced Security Function (/AS) User's Manual	IM 04L55B01-05EN	Describes how to use the advanced security function (/AS option).
Models GX10/GX20/GP10/GP20/GM10 Log Scale (/LG) User's Manual	IM 04L51B01-06EN	Describes how to use the log scale (/LG option).
Models GX10/GX20/GP10/GP20/GM10 EtherNet/IP(/E1) Communication Interface User's Manual	IM 04L51B01-18EN	Describes how to use the communication functions through the EtherNet/IP (/E1 option).
Models GX10/GX20/GP10/GP20/GM10 WT Communication (/E2) User's Manual	IM 04L51B01-19EN	Describes how to use WT communication (/E2 option).
Models GX10/GX20/GP10/GP20/GM10 OPC-UA Server (/E3) User's Manual	IM 04L51B01-20EN	Describes how to use the OPC-UA server function (/E3 option).
Models GX10/GX20/GP10/GP20/GM10 SLMP Communication (/E4) User's Manual	IM 04L51B01-21EN	Describes how to use SLMP communication function (/E4 option).
Models GX10/GX20/GP10/GP20/GM10/GX90NW PROFINET Communication User's Manual	IM 04L51B01-22EN	Describes how to use PROFINET communication function.
Models GX10/GX20/GP10/GP20/GM10 Loop Control Function, Program Control Function (/PG Option) User's Manual	IM 04L51B01-31EN	Describes how to use the PID control function and program control (/PG option) function.
Data Acquisition System GM Integration Bar Graph Function (/WH) User's Manual	IM 04L55B01-07EN	Describes how to use the integration bar graph display function (/WH option).

Revisions

December 2014	1st Edition	April 2021	11th Edition
August 2015	2nd Edition	May 2022	12th Edition
December 2015	3rd Edition	September 2022	13th Edition
March 2016	4th Edition	March 2023	14th Edition
June 2017	5th Edition	September 2023	15th Edition
June 2018	6th Edition	October 2023	16th Edition
July 2018	7th Edition		
September 2018	8th Edition		
March 2019	9th Edition		
December 2019	10th Edition		

Notes

- The contents of this manual are subject to change without prior notice as a result of continuing improvements to the instrument's performance and functions.
- Every effort has been made in the preparation of this manual to ensure the accuracy of its contents. However, should you have any questions or find any errors, please contact your nearest YOKOGAWA dealer.
- Copying or reproducing all or any part of the contents of this manual without YOKOGAWA's permission is strictly prohibited.

QR code

The product may have a QR Code pasted for efficient plant maintenance work and asset information management.

It enables confirming the specifications of purchased products and user's manuals. For more details, please refer to the following URL.

<https://www.yokogawa.com/qr-code>

QR Code is a registered trademark of DENSO WAVE INCORPORATED.

Trademarks

- SMARTDAC+ is a registered trademark or trademark of Yokogawa Electric Corporation.
- Microsoft, MS, Microsoft Edge and Windows are registered trademarks or trademarks of Microsoft Corporation in the United States and other countries.
- Pentium is a registered trademark of Intel Corporation.
- Adobe and Acrobat are registered trademarks or trademarks of Adobe Systems Incorporated.
- Kerberos is a trademark of Massachusetts Institute of Technology (MIT).
- Google Chrome is a trademark or registered trademark of Google LLC.
- Company and product names that appear in this manual are registered trademarks or trademarks of their respective holders.
- The company and product names used in this manual are not accompanied by the registered trademark or trademark symbols (® and ™).

About the Usage of Open Source Software

This product uses open source software.

For details on using open source software, see Regarding the Downloading and Installing for the Software, Manuals and Labels (IM 04L61B01-11EN).

Compliance with Radio Laws of Various Countries (Bluetooth (/ C8 option) only)

• Radio Law of Japan

This product contains radio equipment that has obtained a certification of construction type as a radio station of a power saving data communication system based on the Radio Law.

Radio equipment name: 001NYCA1293

• FCC Approval

FCC CAUTION

Changes or modifications not expressly approved by the party responsible for compliance could void the user's authority to operate the equipment.

Note: This equipment has been tested and found to comply with the limits for a Class A digital device, pursuant to part 15 of the FCC Rules. These limits are designed to provide reasonable protection against harmful interference when the equipment is operated in a commercial environment. This equipment generates, uses, and can radiate radio frequency energy and, if not installed and used in accordance with the instruction manual, may cause harmful interference to radio communications. Operation of this equipment in a residential area is likely to cause harmful interference in which case the user will be required to correct the interference at his own expense.

This transmitter must not be co-located or operated in conjunction with any other antenna or transmitter.

This equipment complies with FCC radiation exposure limits set forth for an uncontrolled environment and meets the FCC radio frequency (RF) Exposure Guidelines. This equipment has very low levels of RF energy that it deemed to comply without maximum permissive exposure evaluation (MPE).

• IC Approval

This Class A digital apparatus complies with Canadian ICES003.

Cet appareil numérique de la classe A est conforme à la norme NMB-003 du Canada

This device complies with Industry Canada licence-exempt RSS standard(s). Operation is subject to the following two conditions: (1) this device may not cause interference, and (2) this device must accept any interference, including interference that may cause undesired operation of the device.

Le présent appareil est conforme aux CNR d'Industrie Canada applicables aux appareils radio exempts de licence.

L'exploitation est autorisée aux deux conditions suivantes : (1) l'appareil ne doit pas produire de brouillage, et (2) l'utilisateur de l'appareil doit accepter tout brouillage radioélectrique subi, même si le brouillage est susceptible d'en compromettre le fonctionnement.

This equipment complies with IC radiation exposure limits set forth for an uncontrolled environment and meets RSS-102 of the IC radio frequency (RF) Exposure rules. This equipment has very low levels of RF energy that it deemed to comply without maximum permissive exposure evaluation (MPE). [*But it is desirable that it should be installed and operated keeping the radiator at least 20cm or more away from person's body.]

Cet équipement est conforme aux limites d'exposition aux rayonnements énoncées pour un environnement non contrôlé et respecte les règles d'exposition aux fréquences radioélectriques (RF) CNR-102 de l'IC. Cet équipement émet une énergie RF très faible qui est considérée conforme sans évaluation de l'exposition maximale autorisée. [*Cependant, il est souhaitable qu'il devrait être installé et utilisé en gardant une distance de 20 cm ou plus entre le dispositif rayonnant et le corps.]

• **China Certification (Radio Waves Act)**

1.

- 使用频率: 2.4 - 2.4835 GHz
- 等效全向辐射功率(EIRP): ≤ 100 mW 或 ≤ 20 dBm
- 最大功率谱密度: ≤ 20 dBm / MHz(EIRP)
- 载频容限: 20 ppm
- 带外发射功率(在2.4-2.4835GHz频段以外)
 ≤ -80 dBm / Hz (EIRP)
- 杂散发射(辐射)功率(对应载波 ± 2.5 倍信道带宽以外):
 ≤ -36 dBm / 100 kHz (30 - 1000 MHz)
 ≤ -33 dBm / 100 kHz (2.4 - 2.4835 GHz)
 ≤ -40 dBm / 1 MHz (3.4 - 3.53 GHz)
 ≤ -40 dBm / 1 MHz (5.725 - 5.85 GHz)
 ≤ -30 dBm / 1 MHz (其它1 - 12.75 GHz)

2. 不得擅自更改发射频率、加大发射功率(包括额外加装射频功率放大器), 不得擅自外接天线或改用其它发射天线;
3. 使用时不得对各种合法的无线电通信业务产生有害干扰; 一旦发现有干扰现象时, 应立即停止使用, 并采取措施消除干扰后方可继续使用;
4. 使用微功率无线电设备, 必须忍受各种无线电业务的干扰或工业、科学及医疗应用设备的辐射干扰;
5. 不得在飞机和机场附近使用。
6. 本设备包含型号核准代码(分别)为: CMIIT ID:2014DJ4615的无线电发射模块。

• **Korea Certification (Radio Waves Act)**

- 해당 무선설비는 전파혼신 가능성이 있으므로 인명안전과 관련된 서비스는 할 수 없습니다
- A 급 기기 (업무용 방송통신기자재)
이 기기는 업무용(A 급) 전자파적합기기로서 판매자 또는 사용자는 이 점을 주의하시기 바라며, 가정외의 지역에서 사용하는 것을 목적으로 합니다.

Version and Functions Described in This Manual

The contents of this manual correspond to release number 5 (see the STYLE S number on the nameplate) and style number 1 (see the STYLE H number on the nameplate) and later.

GM10 Versions and Functions

► For the procedure to check the version, see “System Information Monitor” on page 3-38.

Edition	Product	Addition and Change
1	Version 2.02	—
2	Version 2.03	<p>Addition of the advanced security function (/AS option).</p> <ul style="list-style-type: none"> • See the Data Acquisition System GM Advanced Security (/AS) User's Manual. <p>A new function for sending e-mail for each alarm level (page 2-159), subdivision of initialized items (page 2-206), subdivision of settings that are loaded (page 2-192), show/hide setting of the Web content selection tree (page 2-170), historical trend display (page 3-18), login support for DARWIN compatible communication (communication command user's manual)</p>
3	Version 3.01	<p>Addition of pulse input module support (page 2-51), increase in the number of math channels (GM10-2: 200 channels) (page 2-70), increase in the number of timers and match time timers (12) (page 2-132), addition of Modbus registers (multi batch support) (page 4-10), addition of aerospace heat treatment (/AH option) (page 2-228)</p> <p>Addition of the multi-batch function (/BT option).</p> <ul style="list-style-type: none"> • See the Multi-Batch Function (/BT) User's Manual. <p>Addition of the OPC-UA server function (/E3 option)</p> <ul style="list-style-type: none"> • See the OPC-UA Server (/E3) User's Manual. <p>Addition of SLMP communication (/E4 option)</p> <ul style="list-style-type: none"> • See the SLMP Communication (/E4) User's Manual.
4	Version 3.02	<p>Quick setting function was added (page 1-72)</p> <p>Description of the port limitation setting of DARWIN compatible communication has been added (page 2-221).</p> <p>Read feature of Modbus register (batch related) has been added (see GM operation setting: page 4-58).</p>
5	Version 4.01	<p>Measurement mode has been added (page 2-210). Support for high-speed AI, 4-wire RTD/resistance modules has been added (page 2-24).</p> <p>Logic math function (/MT option) has been added (page 2-91).</p> <p>Variable constants have been added (page 2-90). Support for analog output modules has been added (page 2-57).</p> <p>Individual settings have been added to initialization (page 2-209). DR commands have been added to DARWIN compatible communication (page 2-222).</p> <p>Support for PID control modules and program control (/PG option):</p> <ul style="list-style-type: none"> • See the Loop Control Function, Program Control Function (/PG Option) User's Manual (IM 04L51B01-31EN).
6	Version 4.02	Calibration correction of the communication channel has been added (page 2-152), (page 2-228).
7	Version 4.03	Support for high withstand voltage AI module has been added.
8	Version 4.04	Automatic restart when a device error has been added (page 5-48).
9	Version 4.06	Removed the use of Java in the Web application. Added Google Chrome to supported browsers.
10	Version 4.07	Data integrity support for Advanced security function and addition of EtherNet/IP communication function.
11	Version 4.09	Changed the time related settings for user restrictions.
12	Version 5.01	Equipment/quality prediction function has been added.
13	Version 5.02	Support for PROFINET communication.
14	Same as 13th edition	Support for KC mark of GX90NW.
15	Same as 13th edition	Support for EN standards.
16	Version 5.03	Support for cross realm authentication function and addition of Modbus register (latest health score result status).

How to Use This Manual

Structure of the Manual

Read the **First Step Guide (IM04L55B01-02EN)** first to familiarize yourself with the basic operation of the GM, and then read this manual. For a description of the communication command functions and the accompanying software programs, read the respective manuals.

This user's manual consists of the following sections.

Chapter	Title and Description
1	GM Feature Overview Introduces the GM features.
2	Configuring the GM Explains how to configure the GM.
3	Operating the GM and Using Network Functions Explains how to operate the GM.
4	Using Modbus Functions (Communicating with Modbus devices) Explains how to use the Modbus functions.
5	Maintenance and Troubleshooting Explains how to inspect and calibrate the GM and describes error messages and troubleshooting.
—	Appendix Explains measurement data file size, the types of data that the GM can generate and how to use them, the text file data format, and so on.
—	General Specifications Provides the specifications of the GM.

Note

- This user's manual covers information regarding GMs whose display language is English (language suffix code "E").
- ► For the procedure to set the display language, see page 2-180 in section 2.26.1, "Setting the Display Language, Temperature Unit, Decimal Point Type, and Date Format".

Conventions Used in This Manual

Unit	
K	Denotes 1024. Example: 768K (file size)
k	Denotes 1000.

Notes



CAUTION

WARNING

CAUTION

Note

Improper handling or use can lead to injury to the user or damage to the instrument. This symbol appears on the instrument to indicate that the user must refer to the user's manual for special instructions. The same symbol appears in the corresponding place in the user's manual to identify those instructions. In the manual, the symbol is used in conjunction with the word "WARNING" or "CAUTION."

Calls attention to actions or conditions that could cause serious or fatal injury to the user, and precautions that can be taken to prevent such occurrences.

Calls attention to actions or conditions that could cause light injury to the user or cause damage to the instrument or user's data, and precautions that can be taken to prevent such occurrences.

Calls attention to information that is important for the proper operation of the instrument.

Reference Item



Reference to related operation or explanation is indicated after this mark.

Example: ► section 4.1

Conventions Used in the Procedural Explanations

Bold characters Denotes key or character strings that appear on the screen.

Example: **Volt**



Indicates the character types that can be used.

1 number, a lowercase alphabet, # symbol

Procedure

Carry out the procedure according to the step numbers. All procedures are written with inexperienced users in mind; depending on the operation, not all steps need to be taken.

Explanation

Explanation gives information such as limitations related the procedure.

Path

Indicates the setup screen and explains the settings.

Description

Contents

Introduction	i
Version and Functions Described in This Manual	v
How to Use This Manual	vi

Chapter 1 GM Feature Overview

1.1	What Is SMARTDAC+ GM?	1-1
1.1.1	Overview	1-1
1.1.2	Features	1-1
1.2	Functions That Ensure Reliable Measurements	1-2
1.2.1	Rich I/O Interface	1-2
1.2.2	Actual Values Underlying Accurate Measurements	1-3
1.2.3	Fail-safe Saving of Recording Data	1-4
1.2.4	Easy Access from Web Browser	1-4
1.2.5	Offline Configuration and Monitoring	1-5
1.2.6	System Configuration Using Data Logging Software GA10 (Sold separately)	1-6
1.3	A Full System Configuration Example	1-7
1.4	GM Application Examples	1-8
1.5	Scalable Data Acquisition System	1-12
1.5.1	Component Devices	1-12
1.5.2	Flexible Support for Channel Additions and Reductions	1-14
1.5.3	Unit Types and Configurations	1-15
1.5.4	Flexible Installation Methods	1-16
1.6	Functions	1-17
1.6.1	Basic Functions	1-17
1.6.2	Recording	1-23
1.6.3	Output	1-27
1.6.4	Storage	1-28
1.6.5	Display (Web browser)	1-29
1.6.6	Various Functions	1-31
1.6.7	Event Action Function	1-34
1.6.8	Control Event Action Function	1-36
1.6.9	Batch Function	1-38
1.6.10	Math Function (/MT option)	1-39
1.6.11	Logic Math Function	1-41
1.6.12	Report Function (/MT option)	1-41
1.6.13	Report Template Function	1-42
1.6.14	Security Function	1-43
1.6.15	Fail, Status Output	1-45
1.6.16	Timer and Internal Switch Functions	1-46
1.6.17	Log Scale Function (/LG option)	1-47
1.6.18	Communication and Network Functions	1-48
1.6.19	SNTP Function	1-49
1.6.20	Mail Transfer Function (SMTP)	1-50
1.6.21	HTTP Function	1-51
1.6.22	Communication Channel Function (/MC option)	1-51
1.6.23	Modbus Function	1-52
1.6.24	SSL Communication Function	1-54
1.6.25	DARWIN Compatible Communication	1-56
1.6.26	EtherNet/IP Function (/E1 option)	1-58
1.6.27	WT Communication Function (/E2 option)	1-59
1.6.28	Bluetooth Function (/C8 option)	1-60
1.6.29	Measurement/Setting Server Function	1-60
1.6.30	Advanced security function (/AS option)	1-60
1.6.31	Multi-batch Function (/BT option)	1-61
1.6.32	Aerospace Heat Treatment (/AH option)	1-61
1.6.33	OPC-UA Server Function (/E3 option)	1-62
1.6.34	SLMP Communication (/E4 option)	1-62
1.6.35	PID Control Function (PID), Program Operation Function (/PG Option)	1-63
1.6.36	Equipment/Quality Prediction Function (Release number 5 and later)	1-63
1.6.37	PROFINET Communication (Release number 5 (Version 5.02) and later)	1-64
1.7	Names of the GM10 Parts and Functions	1-65

1.7.1	7 segment LED	1-65
1.7.2	Status Display	1-66
1.7.3	START, STOP, USER1, and USER2 Keys	1-68
1.7.4	Operation Mode	1-70
1.7.5	USB Port	1-70
1.7.6	RS-422/485 Serial Port (/C3 option)	1-70
1.7.7	Ethernet Port	1-70
1.7.8	SD Card Slot	1-71
1.8	Quick Setting Function (Release number 3 (Version 3.02) and later).....	1-72

Chapter 2 Configuring the GM

2.1	Preparing to Use the Web Application	2-1
2.1.1	Connecting to a Network.....	2-1
2.1.2	Setting the IP Address (IP Address Configurator)	2-2
2.1.3	Web Application Overview	2-3
2.1.4	Starting and Closing the Web Application	2-4
2.1.5	Setup Guide	2-9
2.1.6	Change settings	2-10
2.2	Setting the Date and Time.....	2-23
2.3	Configuring AI Channels (Analog (including DI) input) channels and AI (mA) channels... 2-24	
2.3.1	Setting the Range	2-24
2.3.2	Setting Alarms	2-32
2.3.3	Setting the Display	2-36
2.3.4	Setting Calibration Correction (Linearizer approximation, linearizer bias, Correction factor (release number 3 and later)).....	2-43
2.4	Configuring DI Channels (Digital input channels)	2-46
2.4.1	Setting the Range	2-46
2.4.2	Setting Alarms	2-47
2.4.3	Setting the Display	2-49
2.5	Configuring Pulse Input Channels (Release number 3 and later).....	2-51
2.5.1	Setting the Range	2-51
2.5.2	Setting Alarms	2-52
2.5.3	Setting the Display	2-54
2.6	Configuring AO Channels (Analog input channels).....	2-57
2.6.1	Setting the Range	2-57
2.6.2	Setting the display	2-61
2.7	Configuring DO Channels (Digital output channels)	2-63
2.7.1	Setting the Range	2-63
2.7.2	Setting the Display	2-67
2.8	Configuring the Control Function and Program Function (/PG option) (Release number 4 and later).....	2-69
2.9	Configuring Math Channels (/MT option)	2-70
2.9.1	Setting Basic Computation Operations (Error indications, operation at start, overflow handling, PSUM overflow* handling).....	2-70
2.9.2	Setting Expressions	2-71
2.9.3	Writing Expressions	2-77
2.9.4	Setting Alarms	2-86
2.9.5	Setting the Display	2-87
2.9.6	Setting Constants to Use in Computation	2-90
2.9.7	Setting Variable Constants to Use in Computation	2-90
2.10	Configuring Logic Math (/MT option).....	2-91
2.10.1	Logic Math Number, Output Destination, Calculation expressions	2-91
2.11	Setting Display Conditions	2-94
2.11.1	Setting the Trend Interval	2-94
2.11.2	Setting Display Groups	2-95
2.11.3	Setting Messages	2-96
2.11.4	Setting Trend Display Conditions	2-96
2.11.5	Turning the Operation from the Monitor Displays On and Off.....	2-97
2.12	Setting Measurement Conditions (Scan interval, A/D integrate, etc.)	2-98
2.12.1	Setting the Scan Interval	2-98
2.12.2	Setting the Over-range Detection Method.....	2-99
2.12.3	Setting the Operation Mode of a Module	2-99
2.12.4	Setting the A/D Integral Time (Other than high-speed AI or PID control modules)	2-101

1

2

3

4

5

App

Index

2.12.5	Setting the Noise Rejection (High-speed AI, PID control module) (Release number 4 and later)	2-102
2.12.6	Setting the Burnout Criteria	2-103
2.12.7	Setting the Chattering Filter for Pulse Input	2-103
2.13	Setting Recording Conditions (Recording mode, recording interval, saving interval)	2-104
2.13.1	Setting the Type of Data to Record (Event or display data) and Recording Conditions	2-104
2.13.2	Configuring Recording Channels	2-111
2.14	Configuring the Dual Interval Settings (Release number 4 and later)	2-112
2.14.1	Setting the Scan Interval	2-112
2.14.2	Setting the Scan Interval of Each Module	2-113
2.14.3	Setting the Recording Conditions	2-113
2.14.4	Configuring Recording Channels	2-115
2.15	Setting the Conditions for Saving Data Files	2-116
2.15.1	Setting the Save Directory, File Header, and File Name	2-116
2.15.2	Setting the Save Method to Media (Auto save or manual save) and Media FIFO	2-118
2.15.3	Setting the File Format of Display Data and Event Data	2-121
2.16	Configuring the Batch Function	2-122
2.16.1	Configuring the Batch Function (Lot-No. digit and Auto increment)	2-122
2.16.2	Setting Batch Text (When the batch function is set to On)	2-122
2.17	Configuring the Report Function (/MT option)	2-124
2.17.1	Setting the Report Type, Creation Time, Data Type, Etc.	2-124
2.17.2	Setting the Channels to Output Reports	2-127
2.18	Using the Report Template Function (/MT option)	2-129
2.18.1	Excel Report Files	2-129
2.18.2	PDF Report Files	2-130
2.18.3	Printing on a Printer over the LAN	2-130
2.18.4	Creating Template-Based Report Files	2-131
2.18.5	Loading and Saving Report Template Files	2-131
2.19	Setting the Timers	2-132
2.19.1	Setting the Timers	2-132
2.19.2	Setting the Match Time Timer	2-133
2.20	Configuring the Event Action Function	2-135
2.20.1	Setting Event Action Numbers and Actions	2-135
2.20.2	Event Action Examples	2-143
2.21	Configuring Communication Channels (/MC option)	2-146
2.21.1	Enabling Communication Channels and Setting the Span, Decimal Point, and Unit	2-146
2.21.2	Setting Alarms	2-148
2.21.3	Setting the Display	2-149
2.21.4	Setting Calibration Correction (Linearizer approximation, linearizer bias, Correction factor (release number 4 (version 4.02) and later))	2-152
2.22	Configuring the Ethernet Communication Function	2-154
2.22.1	Setting Basic Communication Conditions	2-154
2.22.2	Configuring the FTP Client Function	2-156
2.22.3	Configuring the SMTP Client Function	2-158
2.22.4	Setting E-mail Transmission Conditions (When the SMTP client function is on)	2-159
2.22.5	Setting the SNMP Client Function	2-162
2.22.6	Configuring the Modbus Client Function (/MC option)	2-164
2.22.7	Configuring the Server Function	2-167
2.22.8	Limiting the Connection to the Modbus Server (GM)	2-168
2.22.9	Setting the Server Functions to Use (FTP, HTTP, SNMP, MODBUS, GENE, DARWIN compatible communication)	2-169
2.22.10	Setting the Web Content Selection Tree	2-171
2.23	Configuring the Serial Communication Function (/C3 option)	2-173
2.23.1	Setting Basic Communication Conditions	2-173
2.23.2	Enabling or Disabling the Modbus Master Function (/MC option) and Setting Communication Conditions	2-175
2.23.3	Setting Modbus Master Transmission Commands	2-176
2.24	Configuring the USB Communication Function	2-177
2.24.1	Turning the USB Communication Function On and Off	2-177
2.24.2	Connecting USB Communication	2-177
2.25	Using the Bluetooth Communication Function (/C8 option)	2-178
2.25.1	Turning the Bluetooth Communication Function On and Off	2-178
2.25.2	Bluetooth Connection	2-179

2.26	Configuring System Settings (Time zone, language, status relay, etc.).....	2-181
2.26.1	Setting the Display Language, Temperature Unit, Decimal Point Type, and Date Format.....	2-181
2.26.2	Setting the Interval for Calculating the Rate-of-Change for Rate-of-Change Alarms.....	2-182
2.26.3	Setting the Alarm Display Hold/Nonhold and Individual Alarm ACK Operation.....	2-183
2.26.4	Setting the Time Zone, Gradual Time Adjustment, and Daylight Saving Time.....	2-183
2.26.5	Setting Internal Switches.....	2-186
2.26.6	Setting the Printer Output Conditions.....	2-187
2.26.7	Setting Instrument Tags.....	2-188
2.26.8	Setting Comments to Setting Parameter Files.....	2-188
2.27	Configuring the Security Functions.....	2-189
2.27.1	Configuring the Security Functions.....	2-189
2.27.2	Setting Registered User Conditions (When touch operation or communication is set to login).. 2-190	2-190
2.27.3	Setting User Restrictions (when communication is set to login).....	2-191
2.27.4	Enabling Key Lock, Releasing the Key Lock.....	2-192
2.28	Saving and Loading Settings.....	2-193
2.28.1	Saving, Loading, and Deleting GM Setting Parameters.....	2-193
2.28.2	Downloading Files.....	2-195
2.28.3	Saving and Loading Report Templates (/MT option).....	2-196
2.28.4	Saving and Loading Setting Parameters, Report Templates, Trusted Certificates, Program Patterns (/PG option) (Release number 4 and later), Profile Trend (/MC option)(Release number 5 and later), Predictive Detection Model (Release number 5 and later).....	2-197
2.28.5	Saving, Loading, and Deleting Trusted Certificates.....	2-199
2.28.6	Saving, Loading, and Deleting Program Patterns (/PG option) (Release number 4 and later).. 2-201	2-201
2.28.7	Saving and loading profile trends (Release number 5 and later).....	2-204
2.28.8	Saving and loading early warning detection models (Release number 5 and later).....	2-205
2.28.9	Saving All the Data* in the Internal Memory.....	2-206
2.29	Initializing and Calibrating the System (Initialization, reconfiguration), Setting the Measurement Mode.....	2-207
2.29.1	Initializing the Settings and the Internal Memory.....	2-207
2.29.2	Initializing Display Groups or Recording Channels Separately.....	2-210
2.29.3	Setting the Measurement Mode.....	2-211
2.29.4	Reconfiguring the GM.....	2-212
2.29.5	Notes on System Configuration.....	2-213
2.30	Configuring Key Creation, Certificate Management, and Encryption/Certificate (SSL communication, PDF electronic signature).....	2-215
2.30.1	Enabling the Encryption Function.....	2-215
2.30.2	Creating a Key.....	2-216
2.30.3	Configuring Certificate Management (Creating self-signed certificates, creating certificate signature requests (CSRs), installing certificates, and installing intermediate certificates) and Deleting Certificates.....	2-217
2.30.4	Configuring the Encryption of the Server Function and Client Function, and Applying PDF Electronic Signatures.....	2-220
2.30.5	Loading, Deleting, and Saving a Trusted Certificate.....	2-220
2.30.6	Verification Confirmation of Unverified Certificates.....	2-220
2.31	Using the DARWIN Compatible Communication Function.....	2-221
2.31.1	Overview.....	2-221
2.31.2	Supported Commands.....	2-223
2.31.3	Configuring the DARWIN Compatible Communication Function.....	2-228
2.31.4	Configuring the GM IP Address, Subnet Mask, and the Like (for Ethernet).....	2-228
2.31.5	Setting the GM's Basic Serial Communication Conditions (for RS-422/485).....	2-228
2.32	Using the Aerospace Heat Treatment (/AH option) (Release number 3 and later).....	2-229
2.32.1	Setting the Calibration Reminder.....	2-229
2.32.2	Notification Screen Display.....	2-230
2.32.3	Displaying Reminders.....	2-231
2.33	Configuring the Equipment/Quality Prediction (Release number 5 and later).....	2-232
2.33.1	Predictive detection model and profile trend loading.....	2-233
2.33.2	Set the start and end conditions of the predictive detection section.....	2-234
2.33.3	Setting the health monitor function.....	2-235
2.33.4	Setting the profile function.....	2-236
2.34	Configuring the Network Module (Release number 5 (Version 5.02) and later).....	2-239

Chapter 3 Operating the GM and Using Network Functions

3.1	Controlling the GM	3-1
3.1.1	Starting and Stopping Recording	3-2
3.1.2	Monitoring the GM Data and Controlling the GM from the Monitor Screen	3-8
3.1.3	Changing the Display Settings on the Browser.....	3-41
3.1.4	Changing the Password	3-42
3.2	Transmitting E-mail Messages.....	3-43
3.2.1	Configuring the SMTP Client Function.....	3-43
3.2.2	Setting the Mail Content.....	3-43
3.2.3	Performing an Mail Transmission Test	3-44
3.2.4	Starting and Stopping E-mail Transmission	3-44
3.2.5	E-mail Format.....	3-45
3.3	Accessing the Measurement Data File on the GM from a PC (FTP server function).....	3-52
3.3.1	Configuring FTP Server Settings	3-52
3.3.2	Accessing the GM from a PC.....	3-52
3.4	Transferring Data Files from the GM (FTP client function).....	3-54
3.4.1	Configuring the FTP Client Function	3-54
3.4.2	Testing the FTP Transfer.....	3-56
3.5	Synchronizing the Time (SNTP client function).....	3-57
3.5.1	Configuring the SNTP Client Function	3-57
3.5.2	Adjusting the Clock Manually.....	3-57
3.6	Transmitting Time Information from the GM to SNTP Client Devices (SNTP server function).....	3-58
3.6.1	Configuring the SNTP Server Function.....	3-58

Chapter 4 Using Modbus Functions (Communicating with Modbus devices)

4.1	Using Modbus/TCP to Enable Other Devices to Read Data from and Write Data to the GM (Modbus server function)	4-1
4.1.1	Setting Basic Network Communication Conditions.....	4-1
4.1.2	Configuring the Modbus Server Function.....	4-1
4.1.3	Reading from and Writing to the GM from Other Devices.....	4-2
4.2	Using Modbus/TCP to Enable the GM to Read Data from and Write Data to Other Devices (Modbus client function)	4-3
4.2.1	Setting Basic Network Communication Conditions.....	4-3
4.2.2	Configuring the Modbus Client Function	4-3
4.2.3	Configuring the Destination Server	4-4
4.2.4	Setting Commands.....	4-4
4.2.5	Checking the Modbus Operation Status	4-7
4.3	Using Modbus to Enable Other Devices to Read Data from and Write Data to the GM (Modbus slave function).....	4-8
4.3.1	Setting Serial Communication Conditions.....	4-8
4.3.2	Reading from and Writing to the GM from Other Devices.....	4-8
4.4	Using Modbus to Enable the GM to Read Data from and Write Data to Other Devices (Modbus master function)	4-9
4.4.1	Setting Serial Communication Conditions.....	4-9
4.4.2	Configuring the Modbus Master Function	4-9
4.4.3	Setting Commands.....	4-9
4.5	Modbus Function and Register Assignments.....	4-10
4.5.1	Modbus Client/Master Function	4-10
4.5.2	Modbus Server/Slave Function	4-12
4.5.3	Register Assignments (Shared with the Modbus server/slave function)	4-12
4.5.4	Input Registers (Shared with the Modbus server/slave function).....	4-15
4.5.5	Hold Registers (Shared with the Modbus server/slave function)	4-38
4.5.6	Coil	4-65
4.5.7	Input Relay	4-66
4.5.8	Property area	4-68

Chapter 5 Maintenance and Troubleshooting

5.1	Maintenance.....	5-1
5.1.1	Periodic Inspection.....	5-1
5.1.2	Calibrating Modules	5-1
5.1.3	Performing A/D Calibration and Adjusting the Input Accuracy of an AI Module	5-5

5.1.4	Calibrating the D/A of AO Modules and Adjusting the Output Accuracy.....	5-11
5.1.5	Calibrating the I/O of PID Modules and Adjusting the I/O Accuracy.....	5-13
5.1.6	Using a Password	5-15
5.1.7	Recommended Replacement Periods for Worn Parts	5-15
5.1.8	Updating the Firmware.....	5-17
5.2	Troubleshooting.....	5-20
5.2.1	Messages.....	5-20
5.2.2	Troubleshooting.....	5-43
5.2.3	Auto Restart When a Device Error Occurs (Release number 4 (version 4.04) and later) ..	5-48

Appendix

Appendix 1	File Size of Event Data and Display Data	App-1
Appendix 2	Types of Data Files That the GM Can Create and How They Can Be Used	App-4
Appendix 3	Text File Data Format.....	App-5
Appendix 4	Creating Report Templates	App-17
Appendix 5	Power Recovery Operation	App-24
Appendix 6	Computation Examples Using Pulse Input.....	App-26
Appendix 7	Terminology.....	App-28

Index

General Specifications

- Data Acquisition System GM
- GX90XA/GX90XD/GX90YD/GX90WD/GX90XP/GX90YA I/O Modules
- GX90UT PID Control Module
- GX60 I/O Base Unit (Expandable I/O), GX90EX Expansion Module
- GX90NW Network Module



Blank

1.1 What Is SMARTDAC+ GM?

1.1.1 Overview

The SMARTDAC+ GM Data Acquisition System is a data logger that excels in versatility and expandability. The main unit contains memory for data acquisition and also supports SD cards for external storage.

The system consists of a Data Acquisition Module (GM10), Power Supply Module (GM90PS), and Module Base (GM90MB), which houses various modules.

GM can operate with SMARTDAC+ series modules.



1.1.2 Features

Flexibly supports channel additions and reductions

- Measurement on up to 420 channels
- Easy installation and reduction of modules with slide locks

Easy Access from Web Browser

- Hardware configuration
- Real time monitoring

Mobile connection ready

- Bluetooth communication (/C8 option)
- Monitoring and configuration from a tablet

High performance, high reliability

- Highly accurate measurement
- Reliable data redundancy with internal memory and external storage medium
- Auto backfill feature (Data Logging Software GA10)

Environmental and noise tolerance

- Wide operating temperature range: -20 to 60°C
- A complete lineup of noise tolerant electromagnetic relay scanner type analog input modules







1.2 Functions That Ensure Reliable Measurements

The GM has four basic functions: measurement, recording, display, and storage. In addition, data can be used in various ways such as system configuration through the standard software (Hardware Configurator) and data file display (Universal Viewer). This section provides an overview of each function.

1.2.1 Rich I/O Interface

• Input

The GM can measure the following types of inputs. The supported input types vary depending on the module.

Input Type	
	DC voltage (DCV)
	Thermocouple (TC)
	Resistance temperature detector (RTD)
	On/Off (voltage-free contact, level), pulse
	DC current (mA) (direct input)
	DC current (through an external shunt resistor connection)
	Pulse

• Measurement

The GM samples the input signals at a specified scan interval and performs A/D conversion. These values become the measured values of each channel.

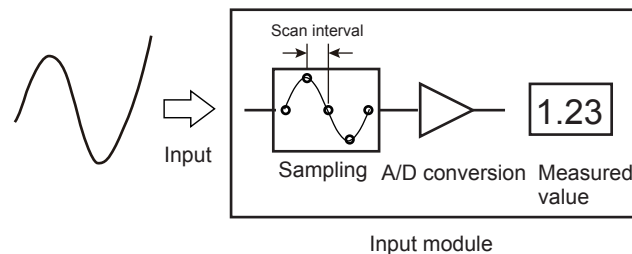

• Output (Relay output)

The GM can generate alarms assigned to measurement channels, turn the output on and off according to manual operation, and output relay signals through the event action function (digital output module, digital input/output module, PID control module).

- ▶ For details on the settings, see page 2-24 in section 2.3, “Configuring AI Channels (Analog (including DI) input) channels and AI (mA) channels” and page 2-63 in section 2.7, “Configuring DO Channels (Digital output channels)”.

1.2.2 Actual Values Underlying Accurate Measurements

The measuring accuracies noted in the general specifications have a margin of error that takes into account the product's components and the equipment used for adjustment and testing.

However, the actual values calculated from the accuracy testing data upon shipment of the instrument from the factory are as follows.

Input Type	Measuring Accuracy*1 (typical value*2)	
DCV	20 mV	$\pm(0.01\%$ of reading +5 μ V)
	60 mV	$\pm(0.01\%$ of reading +5 μ V)
	6 V(1-5 V)	$\pm(0.01\%$ of reading +2mV)
TC *3	R, S	$\pm 1.1^{\circ}$ C
	B	$\pm 1.5^{\circ}$ C
	K (-200.0 to 1370.0°C)	$\pm(0.01\%$ of reading +0.2°C) for 0.0 to 1370.0°C; $\pm(0.15\%$ of reading +0.2°C) for -200.0 to 0.0°C
	K (-200.0 to 500.0°C)	$\pm 0.2^{\circ}$ C for 0.0 to 500.0°C; $\pm (0.15\%$ of reading +0.2°C) for -200.0 to 0.0°C
	J	$\pm 0.2^{\circ}$ C for 0.0 to 1100.0 °C; $\pm(0.10\%$ of reading +0.2 °C) for -200.0 to 0.0°C
	T	$\pm 0.2^{\circ}$ C for 0.0 to 400.0°C; $\pm (0.10\%$ of rdg +0.2 °C) for -200.0 to 0.0 °C
	N	$\pm(0.01\%$ of reading +0.2°C) for 0.0 to 1300.0°C; $\pm(0.22\%$ of reading +0.2°C) for -200.0 to 0.0°C
RTD	Pt100 (-200.0 to 850.0°C)	$\pm(0.02\%$ of reading +0.2°C)
	Pt100 (high resolution) (-150.00 to 150.00°C)	$\pm(0.02\%$ of reading +0.16°C)

* Applies to GX90XA-10-U2, A/D integration time 16.67 ms or more, General operating conditions: 23 \pm 2 °C, 55 \pm 10% RH, supply voltage 90–132, 180–264 V AC, power frequency within 50/60 Hz \pm 1%, warm-up of 30 minutes or more, no vibrations or other hindrances to performance.

*2 For the measuring accuracy (guaranteed), see the module's general specifications (GS 04L53B01-01EN).

*3 These values do not include the reference junction compensation accuracy.

• For details on modules with higher guaranteed accuracy specifications, contact your nearest YOKOGAWA dealer.

1.2.3 Fail-safe Saving of Recording Data

- **Data Storage**

The GM supports long-term recording and multi-channel recording. Measurement data is constantly saved in internal memory and can be transferred periodically to an external storage medium (SD card). Moreover, the FTP client function can be used to provide data redundancy using a file server. Measurement data is saved without fail even in a sudden power interruption. Data can be saved automatically or manually to an external storage medium.

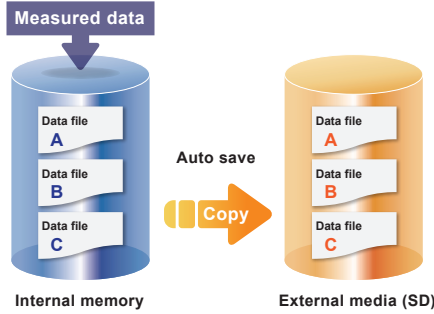

- **Data Types**

Based on the sampled measurement values, the GM can record two types of measurement data: event data and display data (the data type depends on the GM settings). Measurement data is saved to internal memory as data files.

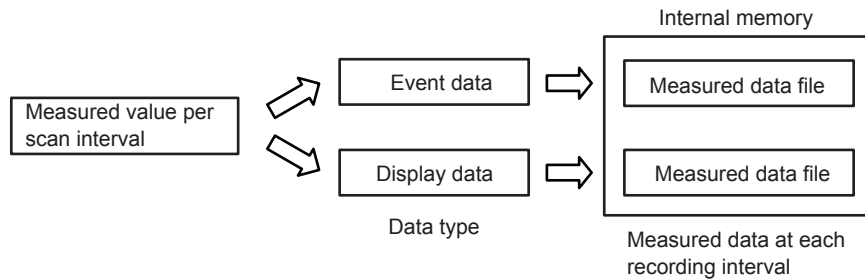

When the measurement mode is Dual interval, measured data of the channels assigned to measurement groups are recorded in the internal memory by each measurement group.

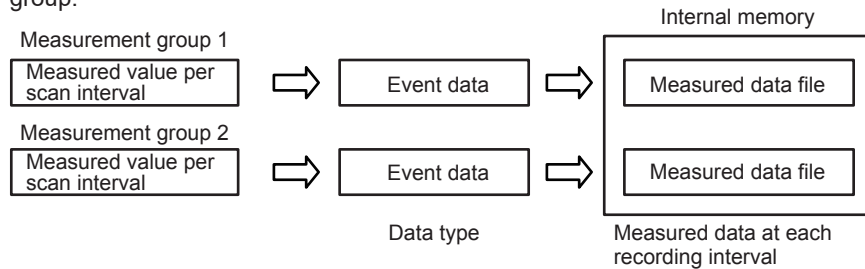

► For details on recording conditions, see page 2-104 in section 2.13, "Setting Recording Conditions (Recording mode, recording interval, saving interval)".

1.2.4 Easy Access from Web Browser

Data being measured can be monitored in real time on a Web browser. You do not need to use a dedicated software application. Using a network environment, you can monitor data over a wide area.

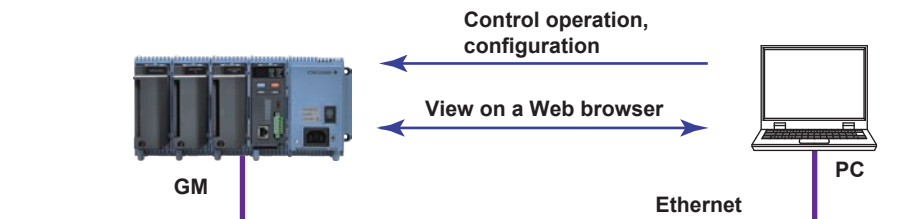

Web screen example

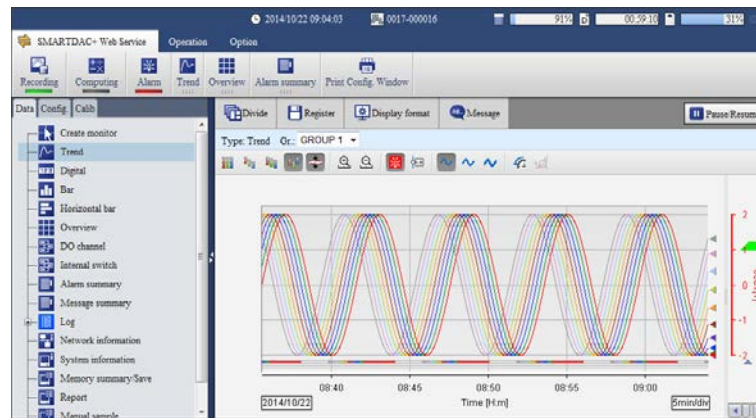

- **Configuration and Operation**

You can configure the GM from a Web browser. You can also start and stop recording, write messages, and so on.

1.2.5 Offline Configuration and Monitoring

- **Hardware Configurator**

This software is used to transfer setup data to the GM and also save setting parameters. USB and Bluetooth connection is possible in addition to Ethernet connection.

Hardware Configurator

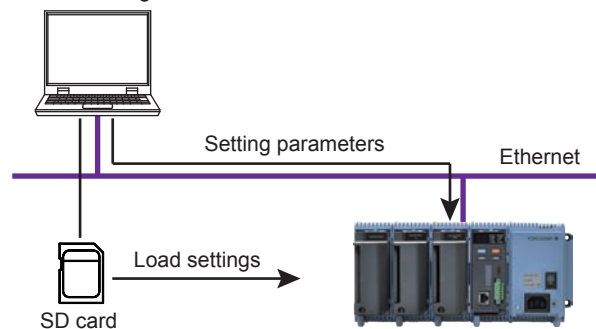

- **Universal Viewer**

This software is used to display measurement data files on a PC and print them. You can also calculate statistics on a specified set of data and convert data to ASCII and Excel formats.

- **IP Address Configurator**

This software is used to set the GM10's IP address, subnet mask, default gateway, and the like.

1.2.6 System Configuration Using Data Logging Software GA10 (Sold separately)

A dedicated software application for configuring a full-fledged system is available. This application is capable of acquiring data from multiple devices including SMARTDAC+ GM.

- Max. 100 devices
- 1 ms high-speed acquisition
- Max. 10000 channels (tags)

Data Logging Software GA10



1.3 A Full System Configuration Example

You can configure a GM system as shown below.

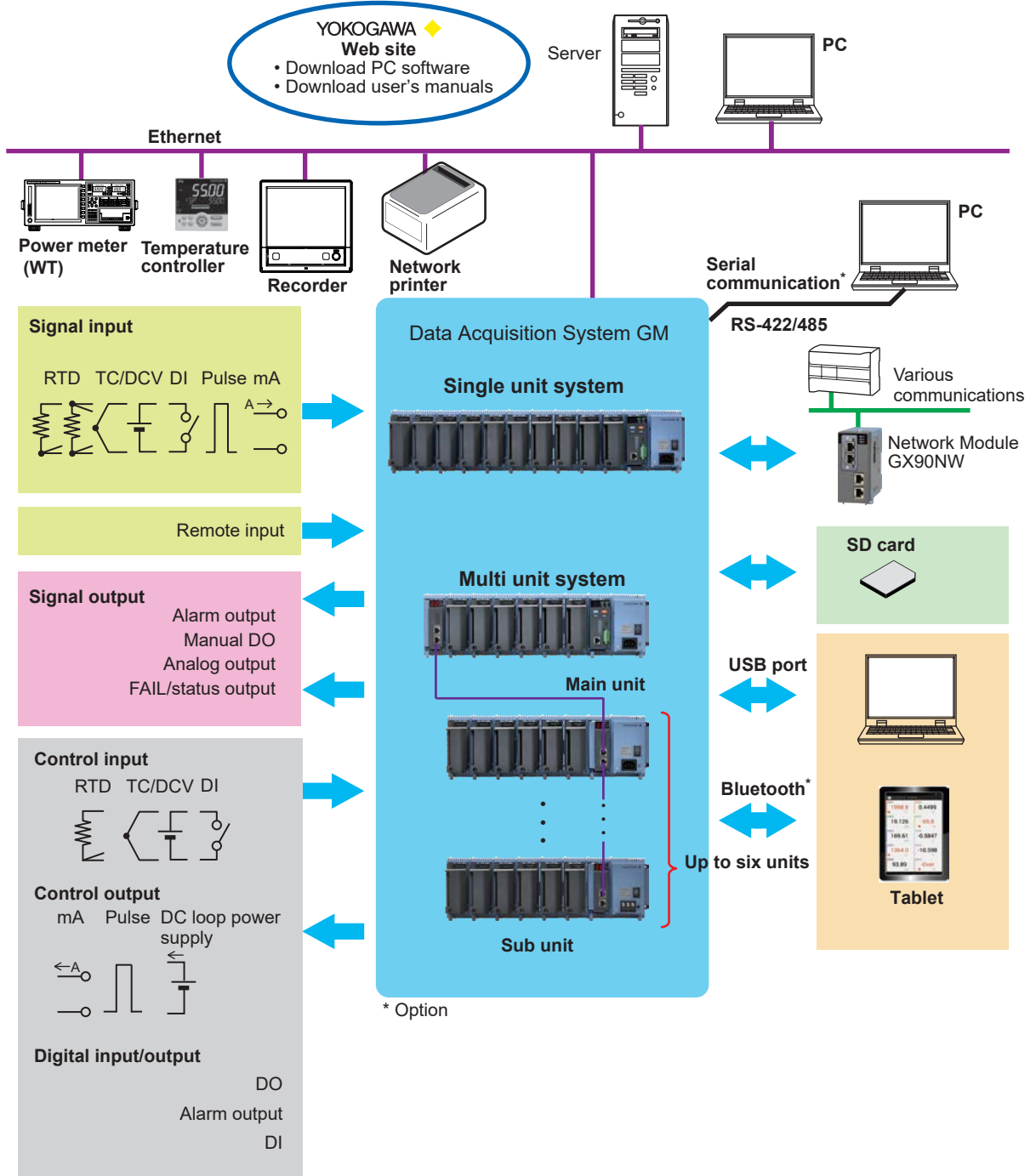

Do not link modules in a way that violates the specifications. Doing so can cause the GM system to crash.
 ► See page 2-212 in section 2.29.5, “Notes on System Configuration”.

1.4 GM Application Examples

This section introduces main application examples in different industries.

Electrical and Electronic

- **Performance evaluation testing of microwave ovens and IH cooking heaters**

- The GM is used to acquire temperature data at multiple points to evaluate temperature distribution and ambient temperature.
- Measurement less susceptible to noise is possible by using electromagnetic relay type modules.

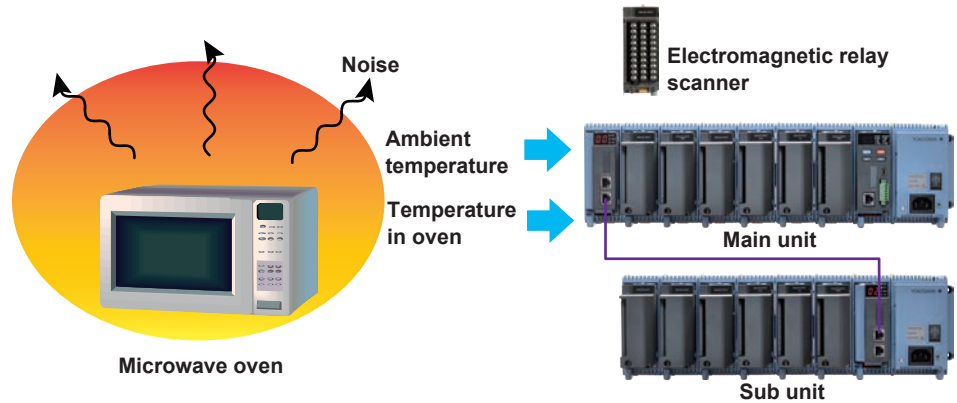

- **Performance evaluation testing of washing machines**

- The GM is used to acquire rotation, vibration, temperature, power consumption, and other types of data of washing machines.
- For power consumption, voltage, current, and the like, the measurement data from WT power meters can be acquired in digital form, which preserves high-precision power measurements. (This requires the WT communication (/E2) option.)

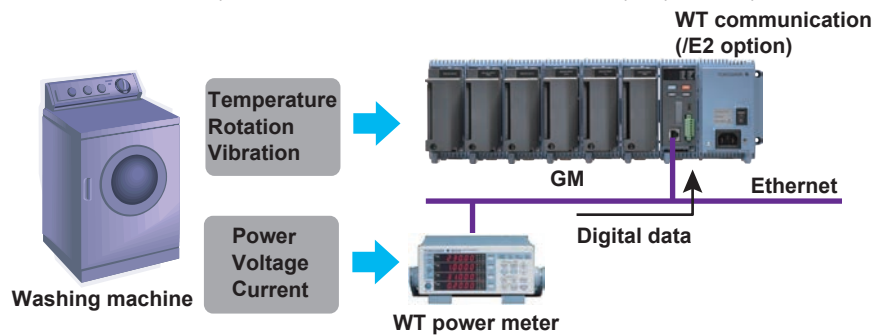

Vehicles

• **Car air conditioner evaluation**

- The GM is used to acquire in-car temperatures, duct temperatures and humidities, supplied voltages, outside air temperatures, engine on/off state, and other types of data.
- The wide operating temperature range of -20 to 60°C enables testing in environmental test labs, hot and cold regions, and so on.
- Monitoring on a tablet is possible with the Bluetooth (/C8) option.

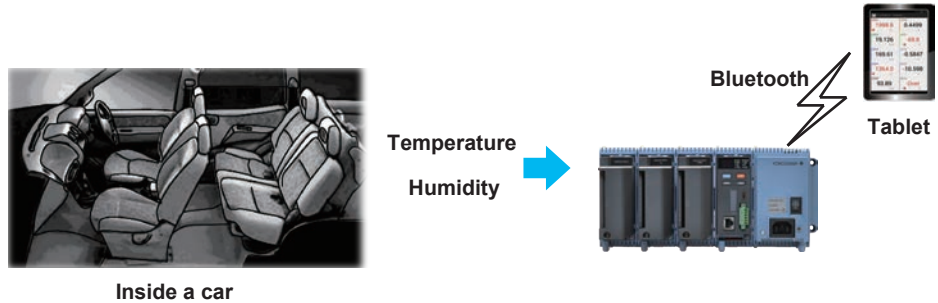

• **Engine durability testing**

- The GM acquires various types of data, such as air temperature, water temperature, rotation, air volume, exhaust gas, in tests performed on engine test benches. Long-term data acquisition is possible such as in durability tests performed by supplying rotation and load control signals and varying the measurement conditions.
- Data acquisition is possible at different time intervals for each bench (multi-logging, (/BT option)) by using the Data Logging Software GA10.

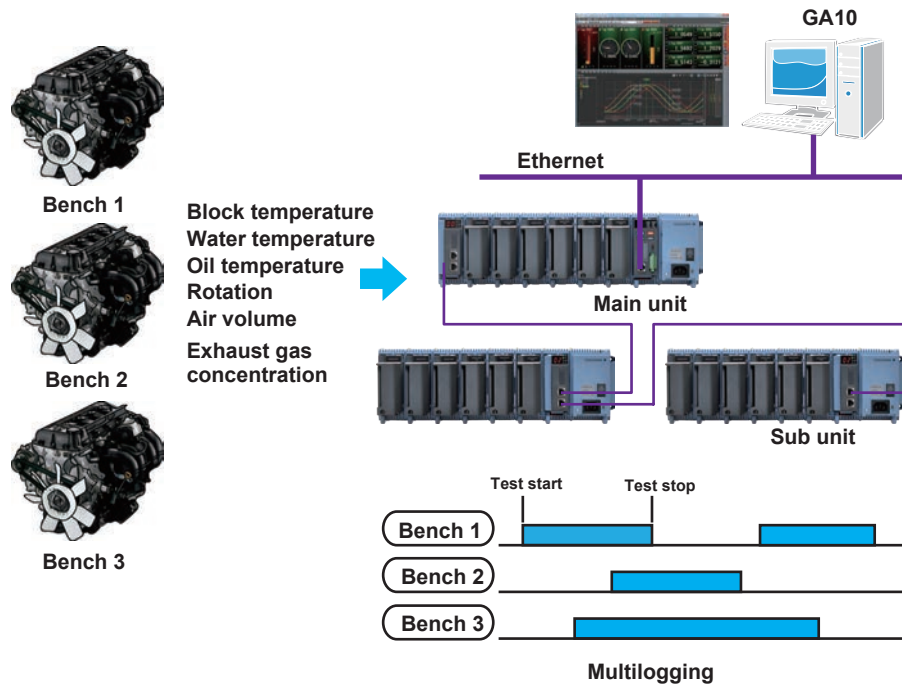

Environmental Monitoring

- **Factory utility monitoring**

- The GM is used to acquire and monitor various types of data, such as power, temperature, flow rate, PH, and residual chlorine concentration, from different utility equipment in factories.
- Equipment maintenance is possible based on the acquired data.

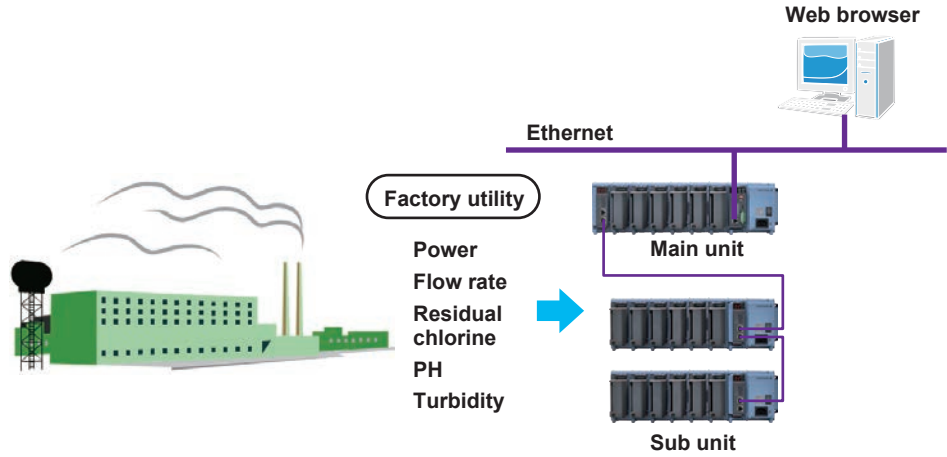

- **Air conditioning monitoring in pharmaceutical labs and warehouses**

- The GM is used to acquire and monitor the temperature, humidity, and the like in storage rooms for pharmaceuticals and foods and warehouses.
- Quality management is possible by acquiring trends and evaluating the effects to the quality of stored products.
- Monitoring on a tablet is possible with the Bluetooth (/C8) option.
- The advanced security function (/AS option) can be added to comply with 21 CFR Part11.

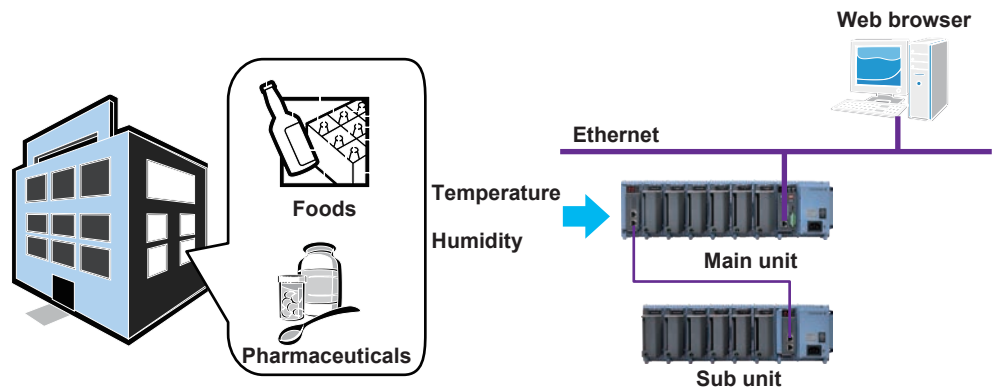

Plants

- **Film coating process monitoring**

- The GM is used to acquire and monitor the volume and components of photosensitizing agents, sheet feeding speeds, temperatures, humidities, the volume of bubbles, and the like.
- Performance and quality management of film is possible.
- Acquiring and monitoring of process data is easy with Data Logging Software GA10.

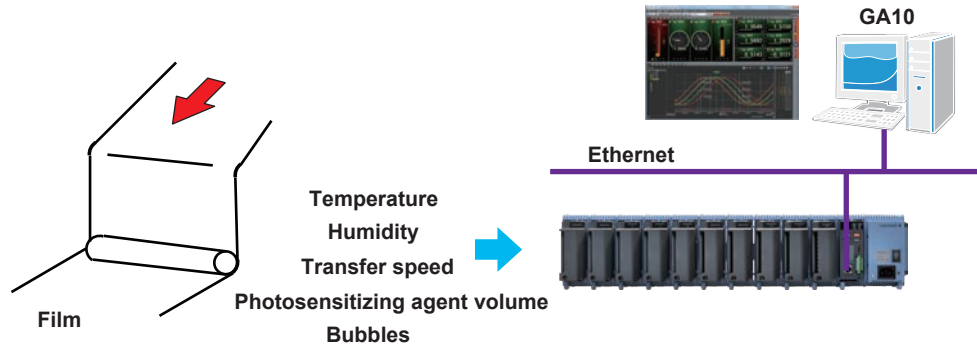

- **Temperature distribution monitoring of melting furnaces**

- The GM is used to acquire temperature data of melting furnaces, which can be monitored from a Web browser.
- Multi-point measurement of up to 100 channels is possible. (GM10-1)

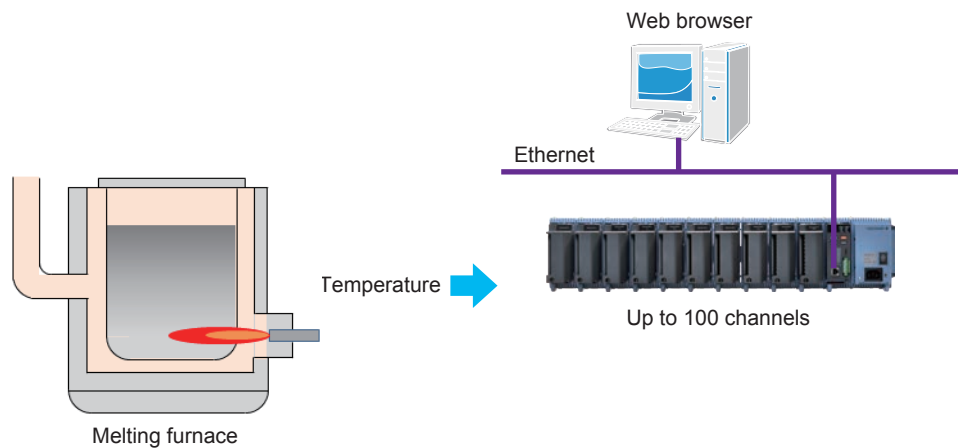



1.5 Scalable Data Acquisition System

1.5.1 Component Devices

A single GM unit consists a combination of the following modules and a module base. A data acquisition module is linked to the left of the power supply module, and input/output modules are linked on the left side of the data acquisition module.

A multi unit system is configured by linking expansion modules and connecting units over a LAN network.

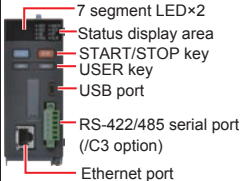
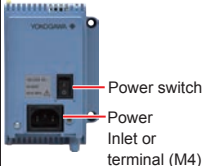
A module base is used to link a data acquisition module, input/output modules, and expansion module.

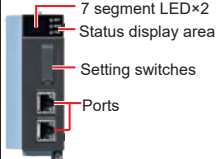
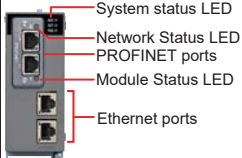
Name	Model	Component Names	Description
Data Acquisition Module	GM10	 <ul style="list-style-type: none"> 7 segment LED×2 Status display area START/STOP key USER key USB port RS-422/485 serial port (/C3 option) Ethernet port 	A module for acquiring data. It is linked to the left of the power supply module. <ul style="list-style-type: none"> • Only one module can be linked to a system.
Power Supply Module	GM90PS	 <ul style="list-style-type: none"> Power switch Power Inlet or terminal (M4) 	A module for supplying power to the unit.
Input/output Module	GX90□□	—	A module for receiving and transmitting signals.
Module Base	GM90MB		A base is used to link a data acquisition module, input/output modules, and expansion module.
Expansion Module	GX90EX	 <ul style="list-style-type: none"> 7 segment LED×2 Status display area Setting switches Ports 	A module for connecting units over a LAN network. An expansion module is used in each unit to configure a multi unit system. <ul style="list-style-type: none"> • The firmware version of the GX90EX that can be used with the SMARTDAC+ GM must be R1.02.01 or later.
Network Module	GX90NW	 <ul style="list-style-type: none"> System status LED Network Status LED PROFINET ports Module Status LED Ethernet ports 	For communication using industrial networks communication protocols. You can connect one network module to one main unit.

Input/output Module

Name	Model	Name	Model
Analog Input	GX90XA	Analog Output	GX90YA
Digital Input	GX90XD	PID Control	GX90UT
Pulse input	GX90XP		
Digital Output	GX90YD		
Digital Input/output	GX90WD		



- Input/output modules may need to have their firmware updated. For details, see page 2-212 in section , “Conditions on the Combination of GM10 Versions and Input/output Modules”.

Analog Input Module Scan Intervals and Measurement Types

Type	Channels	Scan interval (fastest)	Scanner	TC	RTD	DCV	DI	mA	Resistor	Use
Universal (-U2)	10	100 ms	SSR	✓	✓	✓	✓			Universal
Low withstand voltage relay (-L1)	10	500 ms	SSR	✓		✓	✓			Low price
Electromagnetic relay (-T1)	10	1 s	Relay	✓		✓	✓			Noise tolerance
DC current input (-C1)	10	100 ms	SSR					✓		mA only
High withstand voltage (-V1)	10	100 ms	SSR	✓		✓	✓			High withstand voltage
High-speed universal (-H0)	4	1ms		✓	✓	✓	✓			High-speed universal
4-wire RTD/resistor (-R1)	6	100ms	SSR		✓				✓	4-wire RTD

1.5.2 Flexible Support for Channel Additions and Reductions

YOKOGAWA's original block structure (patented)

- Modules can be added one module at a time.
 - Unique structure in which modules are linked to a module base
 - Secure linking using a module base (slide lock mechanism; can be fastened with screws)
 - Module insertion and removal from the front, easy maintenance
- The GM can be set up in a single unit system or multi unit system.

■ Max. 100 Channel Measurement Standard (Single unit)

This system consists only of a main unit for data acquisition.



■ Max. 420 Channel Measurement through Expansion (Multi unit)

This system consists of sub units connected to a main unit for data acquisition.

Up to six sub units can be connected.

The GM10-2 can be used to configure a 420-channel (input channel) system. Expansion modules are used to connect between the main unit and sub units and between sub units. Units are connected using Ethernet cables. The connections can extend up to 100 m total. Less wiring is possible by distribution such as when measurement locations are separated far apart.

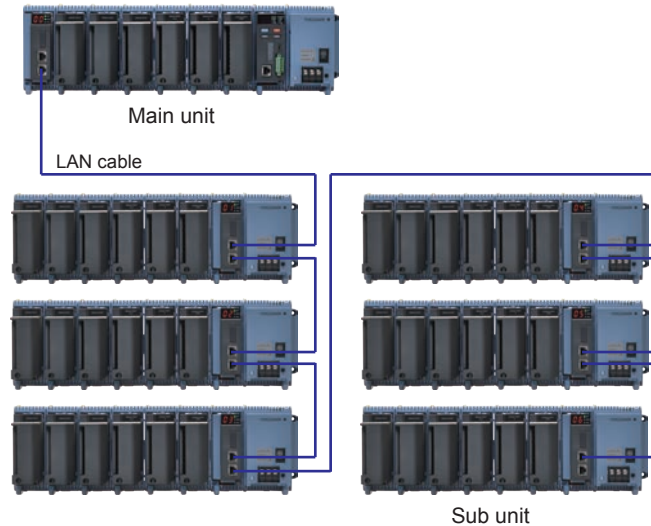

* The main unit and sub units are connected directly using LAN cables. Hubs and repeaters cannot be used.

■ Less Wiring by Distribution

If the measuring site and the data logger installation location are far apart, a sub unit can be installed at the site to monitor the data without having to extend thermocouple and other signal wires over long distances.

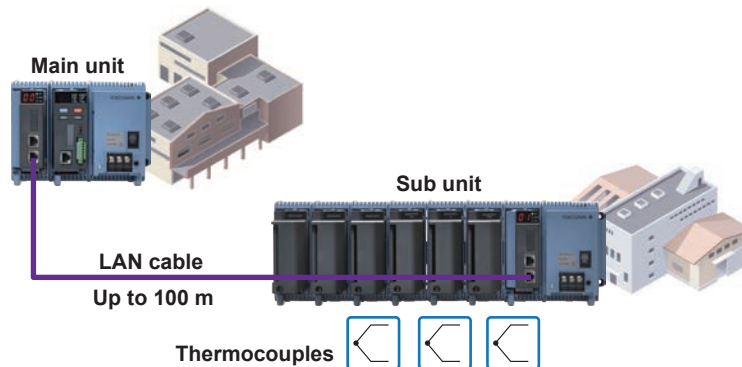

1.5.3 Unit Types and Configurations

There are two GM unit configurations: main unit and sub unit. A system consisting only of a main unit is called a single unit system; a system consisting of a main unit and sub units is called a multi unit system.

■ Main Unit

The main unit includes the data acquisition module.

Up to 10 input/output modules can be linked.

An expansion module (GX90EX) is linked to the left end when connecting to sub units.

In this case, the maximum number of input/output modules that can be linked is six.

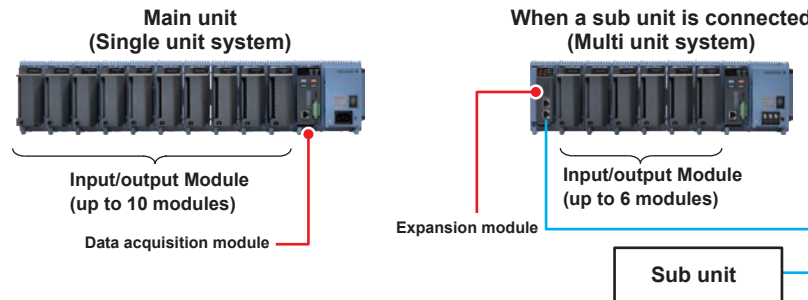

► For details on how to configure expansion modules, see the First Step Guide.

■ Sub Unit

A sub unit is connected to the main unit. An expansion module (GX90EX) is linked to connect to the main unit or other sub units with LAN cables. The maximum connection distance between two units is 100 m. Only cascaded connection is allowed.

An expansion module is linked to the left of the power supply module, and input/output modules are linked on the left side of the data acquisition module. Up to six input/output modules can be linked.

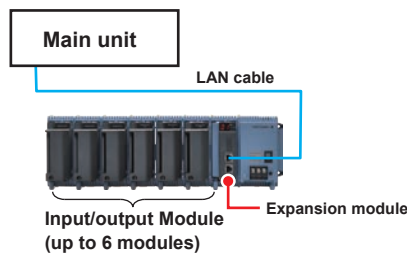

Note

The multi unit system support only cascaded connections. If connected in a ring, none of the sub units will be identified.

■ Notes on Connecting Modules

See the GM10 Data Acquisition System First Step Guide (IM 04L55B01-02EN) and GM Data Acquisition System General Specifications (GS 04L55B01-01EN).



Do not link modules in a way that violates the specifications. Doing so can cause the GM system to crash.

► See page 2-212 in section 2.29.5, “Notes on System Configuration”.

1.5.4 Flexible Installation Methods

The GM can be not only installed on a desktop but also mounted on a DIN rail or a wall.

■ Desktop



■ DIN Rail Mounting

The GM can be mounted easily on a DIN rail using the latches on the rear of the module base.

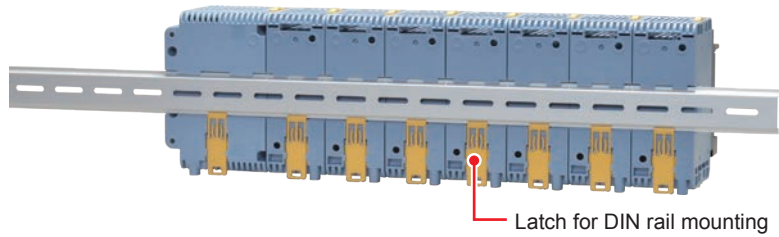

■ Wall Mounting

The GM can be mounted on a wall using the screw holes on the power supply module and module base.

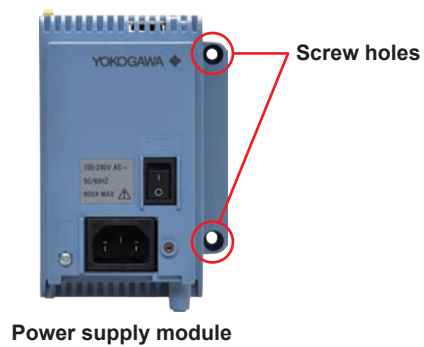
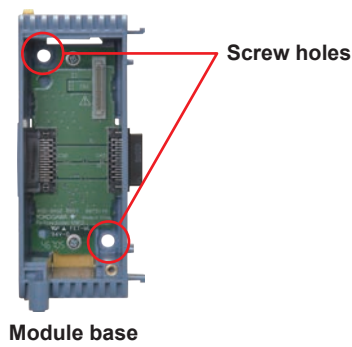
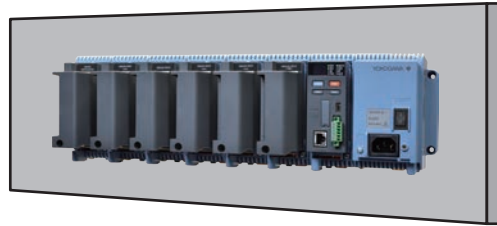

1.6 Functions

1.6.1 Basic Functions

Measurement

- **Input/output Types**

A rich lineup of input/output modules are available.

You can select the best-suited module according to your measurement needs.



Input/output Module

Module	Model	Type (Suffix code)	Number of channels
Analog input	GX90XA	Universal, solid state relay, scanner type (-U2)	10
		Electromagnetic relay, scanner type (-T1)	
		Low withstand voltage relay, scanner type (-L1)	
		DC current (mA), scanner type (-C1)	
		High withstand voltage, scanner type (-V1)	
		High-speed universal, individual A/D type (-H0)	
		4-wire RTD/resistor, scanner type (-R1)	4
Digital Input	GX90XD	—	16
Pulse input	GX90XP	—	10
Digital Output	GX90YD	—	6
Digital Input/output	GX90WD	—	Input: 8, Output: 6
Analog output	GX90YA	—	4
PID control	GX90UT	—	PID: 6, AI: 2, AO: 2, DI: 8, DO: 8

The following table shows the input types supported by each module.

Module	Type (Suffix code)	Input Type							
		(DCV)	(GS)	(TC)	(RTD)	(DI) ²	(mA)	Pulse ³	Resistance
Analog input	-U2	✓	✓	✓	✓	✓	✓ ¹		
	-T1	✓	✓	✓		✓	✓ ¹		
	-L1	✓	✓	✓		✓	✓ ¹		
	-C1						✓		
	-V1	✓	✓	✓		✓	✓ ¹		
	-H0	✓	✓	✓	✓	✓	✓ ¹		
	-R1				✓				✓
Digital input	—					✓		✓	
Digital input/output	—					✓		✓	
Pulse input	—					✓		✓	
Analog output	—						✓		
PID control	—	✓	✓	✓	✓	✓	✓ ¹		

1 When an external shunt resistor is connected

2 Will be voltage or contact for analog input modules

3 Pulse input modules can receive also Level (5 V logic) signals.

Pulse measurement

- Using digital input and digital input/output modules, you can measure pulses of flow rates, rain gauges, and the like (250 Hz max.,* minimum pulse width: 2 ms). To perform pulse measurements, the GM10 needs to have the computation (/MT) option.
 - * When chattering filter is off. 125 Hz when chattering filter is on.
- Pulse input modules can be used to integrate pulse output (20 kHz maximum, minimum pulse width 25 μs) from flowmeters and the like.
 - * To perform pulse integration, the GM10 needs to have the computation (/MT) option.

• **Input Calculation**

The following calculations can be performed on input signals.

Linear scaling

Converts the input value unit to obtain the measured value.

For example, linear scaling is used to convert the output signal from a temperature converter into temperature values.

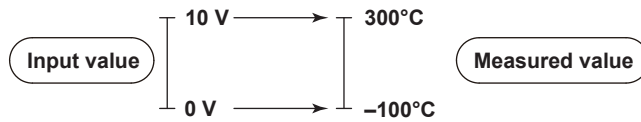

• **Delta**

The measured value of the channel is set to the difference with respect to the measured value of the reference channel.

For example, this is useful when you want to measure the temperature difference in reference to the room temperature.

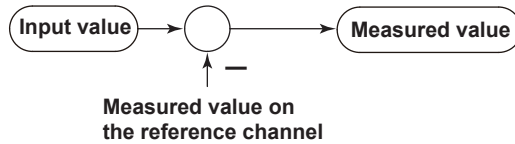

• **Square root computation**

Takes the square root of the input value and converts the unit to obtain the measured value.

In a differential pressure flowmeter, the output signal is proportional to the square of the flow rate. Therefore, to measure on a GM, square rooting is required.

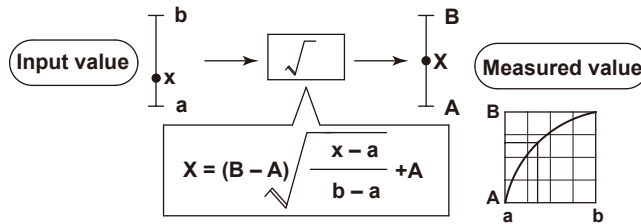

• **Low-cut**

Set the low-cut value for square rooting.

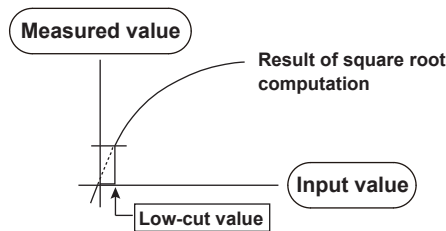

• **Log scale (/LG1)**

The GM supports Log input, pseudo log, and log linear input.

For details on the function, page 1-47 in section 1.6.17, "Log Scale Function (/LG option)".

Other Types of Input Processing

- **Moving average**

Performs moving average over the specified number of sampling points. For example, you can use this to smooth the data when the input signal is fluctuating due to noise or other unwanted influences.

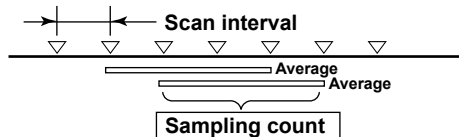

- **Bias**

This is used to add a constant value to input values or scaled values (input computation). Channel on which bias is added

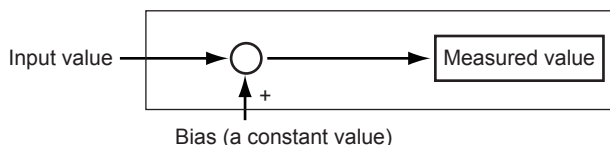

- **Calibration correction**

Input values can be corrected using segment linearization. Up to 12 correction points can be specified.

Linearizer approximation

Corrects input values using characteristics specified with segments to derive output values.

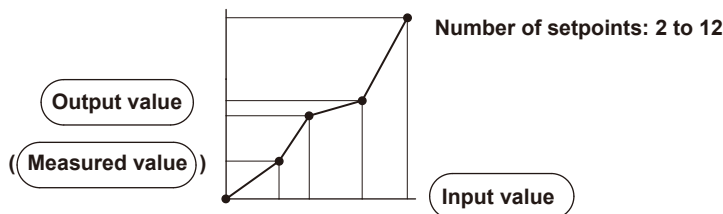

Linearizer bias

Corrects input values using bias values specified with segments to derive output values.

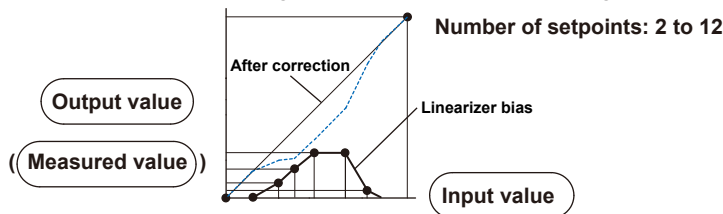

Correction factor

Corrects input values using the instrument correction factor and sensor correction factor specified with segments to derive output values.

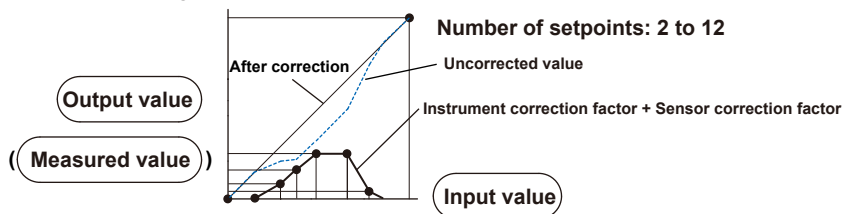

■ Scan Interval

This is the interval at which the input signal is sampled and converted into digital values (A/D conversion). You can select from 1 ms, 2 ms, 5 ms, 10 ms, 20 ms, 50 ms, 100 ms, 200 ms, 500 ms, 1 s, 2 s, and 5 s. The scan intervals that you can set vary depending on the module. If modules with different shortest scan intervals are present in the system, the shortest scan interval that you can set is the shortest scan interval of the slowest module.

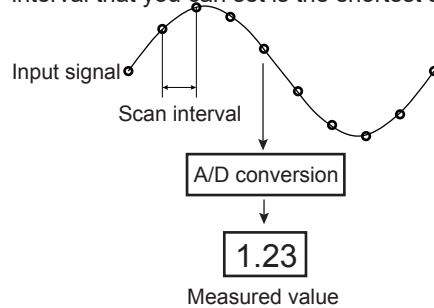

Shortest scan intervals by analog input module suffix codes

Module	Type	Number of Channels	Shortest Scan Interval
GX90XA analog input	Universal (-U2)	10	100 ms
	Low withstand voltage relay (-L1)	10	500 ms
	Electromagnetic relay (-T1)	10	1 s
	DC current input (-C1)	10	100 ms
	High withstand voltage	10	100 ms
	High-speed universal (-H0)	4	1 ms
	4-wire RTD/resistor (-R1)	6	100 ms

■ A/D Integration Time

The GM uses an A/D converter to convert sampled analog signals to digital signals. The power supply frequency noise can be effectively eliminated by setting the integration time of the A/D converter to match the time period corresponding to one cycle of the power supply or an integer multiple of one cycle.

Common (36.67 ms/100 ms) can be specified to effectively eliminate power supply frequency noise for both 50 Hz and 60 Hz.

Note that the selectable A/D integration times vary depending on the scan interval settings.

Integration Time	Explanation			
Auto	The GM automatically detects the power supply frequency and sets the integration time to 16.67 ms for 60 Hz and 20 ms for 50 Hz. However, if the module operation mode is 10ch and the scan interval is 100 ms or 200 ms, the A/D integration time is fixed at 1.67 ms.			
50Hz	Sets the integration time to 20 ms.			
60Hz	Sets the integration time to 16.67 ms.			
Common	Sets the integration time to 16.67 ms, 20 ms, 36.67 ms, or 100 ms. Integration time and scan interval by module			
	Type	Integration Time	Scan Interval	
			10ch mode / 2ch mode 6ch mode	
	Universal	36.67ms	1s	
	DC current input	100ms	2 s or 5 s	
	4-wire RTD/resistance			
	High withstand voltage			
	Electromagnetic relay	16.67ms/20ms	1s	—
		36.67ms	2s	—
		100ms	5s	—
Low withstand voltage relay	36.67ms	2s	—	
	100ms	5s	—	

■ Measurement Mode

By switching the measurement mode according to the measurement target and measurement conditions, you can perform high-speed measurements as well as simultaneous high-speed and low-speed measurements.

High-speed measurement at the shortest measurement interval of 1 ms

Measurement at the shortest interval of 1 ms is possible by using a high-speed analog input module equipped with an original A/D converter developed by YOKOGAWA.

Dual interval measurement

Two different scan intervals can be used together in a single system. Slow changing signals such as temperature and fast changing signals such as pressure and vibration can be measured simultaneously and efficiently. Scan groups are specified on each module.

■ Reference Junction Compensation (RJC)

Performs reference junction compensation on thermocouple input.

You can select whether to perform reference junction compensation internally within GM or externally (with a reference junction compensator).

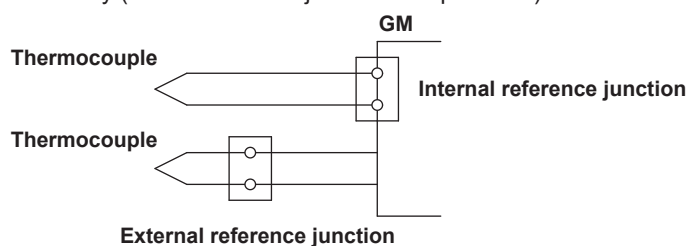

■ Burnout Detection

When the range type is set to thermocouple (TC), resistance temperature detector (RTD) or general signal (GS (1-5V), GS (4-20 mA)), the GM detects sensor burnouts.

If the range type is set to GS (1-5) or GS (4-20 mA), you can set the high and low limits for determining burnouts.

Burnout

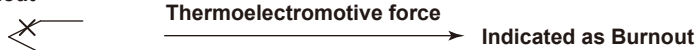

Burnout



Burnout criteria (for GS (1-5V), GS (4-20 mA) ranges)

Item	Selectable Range (Percentage of the specified span width)
Lower Limit of Burnout	-20.0 to -5.0%
Upper limit of burnout	105.0 to 120.0%

■ **Operation Modes of Modules**

● **AI modules**

2ch mode and 10ch or 6ch mode are available.

In 10ch mode, measurement is possible on CH1 to CH10.

In 6ch mode, measurement is possible on CH1 to CH6.

In 2ch mode, measurement is possible only on CH1 and CH2. (CH3 and higher channels are fixed to Skip.)

In 10ch mode, when the scan interval is 100 ms or 200 ms, the A/D integration time is fixed at 1.67 ms. Since the power frequency noise is not eliminated, the measured values may fluctuate, especially in temperature measurements using thermocouples. In 2ch mode, when the scan interval is 100 ms or 200 ms, the A/D integration time is 16.67 ms or 20 ms. This allows power frequency noise to be eliminated.

Note that the selectable A/D integration times vary depending on the 2ch/6ch/10ch mode and scan interval settings.

For the high-speed AI module, power frequency noise is rejected using the noise rejection feature.

● **DI modules**

Normal and remote operation modes are available.

For normal DI input, specify Normal.

Specify Remote to use the DI module as a remote control input.

When there are multiple DI modules, only one of them can be set to Remote.

Remote can only be specified for a DI module or DI/DO module installed in the main unit.

To use remote control through event action, select Remote.

1.6.2 Recording

■ Recording Interval

The recording interval is the interval at which data sampled at the scan interval is recorded as measurement data.

For details on the methods for recording event data and display data, see the next page.

● Event data

Set the interval at which to record measurement data.

You cannot choose a recording interval that is shorter than the scan interval.

● Display data

The recording interval of display data is determined by the trend interval [/div] setting.

The GM records the maximum and minimum values from within the data sampled at the scan interval within the recording interval.

■ Data Types

The GM can record the following types of data.

If you are using the advanced security function (/AS option), see section 1.2.1, "Data Types," in the Advanced Security Function User's Manual (IM 04L55B01-05EN).

Data Type	Explanation
Event data	<ul style="list-style-type: none"> Measurement data that is recorded at the specified recording interval. There are two modes. One mode starts recording when a trigger occurs. The other mode records at all times. A header string (shared with other files) can be written in the file. Contains alarm and message information. Data format: Binary and text
Display data	<ul style="list-style-type: none"> Measurement data that records the maximum and minimum values of the sampled data within the recording interval, which is determined by the specified trend interval. A header string (shared with other files) can be written in the file. Contains alarm and message information. Data format: Binary and text
Manual sampled data	<ul style="list-style-type: none"> Instantaneous value of the measured data when a manual sample operation is executed. A header string (shared with other files) can be written in the file. Data format: Text
Report data (/MT option)	<ul style="list-style-type: none"> Hourly, daily, weekly, monthly, batch, daily custom report data. Report data is created at an interval that is determined by the report type (one hour for hourly reports, one day for daily reports, and so on). A header string (shared with other files) can be written in the file. Data format: Text The data can be converted to Excel and PDF formats.
Setting parameters	<ul style="list-style-type: none"> The setting parameters of the GM. Data format: Text

■ **Methods for Recording Event Data and Display Data**

This section explains the methods for recording event data and display data.

● **Event data**

The GM records the data sampled at the scan interval at the specified recording interval. Detailed data is recorded, but the data size becomes large.

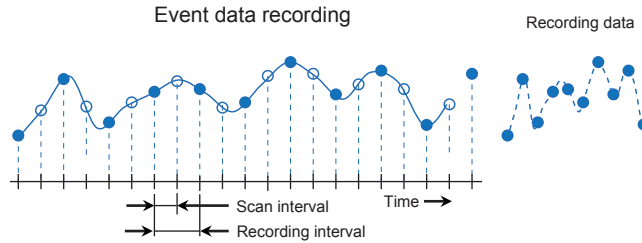

● **Display data**

Display data can be likened to recording to chart paper on conventional pen recorders. Using the data sampled at the scan interval, the GM records the maximum and minimum sampling data values within each recording interval (interval determined by the trend interval [div]).

Detailed data of each sample is not retained, but because the maximum and minimum data values are recorded, display data expresses the fluctuation range in each recording interval. In addition, because the number of data values can be reduced, display data allows long-term data recording to the internal memory.

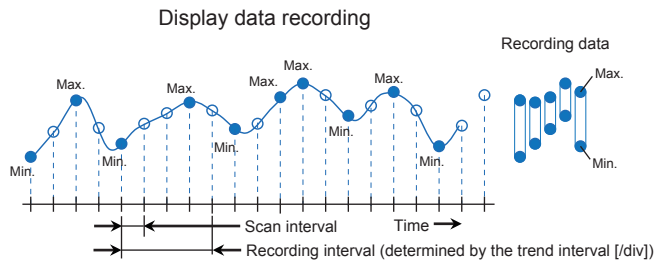

Recording interval of display data

The recording interval of display data is determined by the trend interval [div] setting. The relationship between the trend interval and the recording interval is shown below.

Trend Interval	5s	10s	15s	30S	1min
Recording Interval	100ms	200ms	500ms	1s	2s
Trend Interval	2min	5min	10min	15min	20min
Recording Interval	4s	10s	20s	30s	40s
Trend Interval	30min	1h	2h	4h	10h
Recording Interval	1min	2min	4min	8min	20min

■ Event Data Recording Modes

The following event data recording modes are available.

● Free

Recording starts when you start it and stops when you stop it. Measurement data is divided by the specified duration (data length).

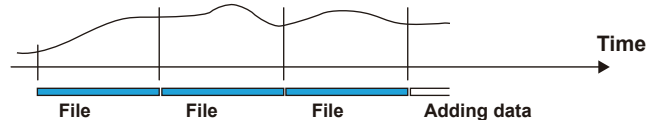

Data length

Set the size of recording data per file. Recording data is divided at the specified file size. The selectable data lengths vary depending on the number of channels to record and the Scan interval setting.

● Single

The GM enters the trigger-wait state when you start recording. After a trigger event occurs, the GM will record data for the specified time (data length) and stop. From this point, the GM will not record even if the trigger condition is met.

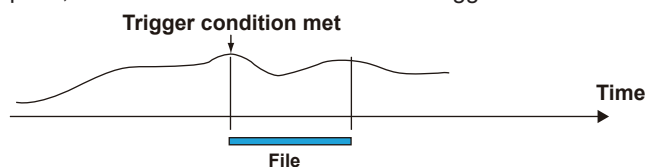

● Repeat

The GM enters the trigger-wait state when you start recording. After a trigger event occurs, the GM will record data for the specified time (data length) and stop. Then, it enters the trigger-wait state again and repeats recording for the specified time (data length) every time the trigger condition is met. To stop recording event data, stop the recording.

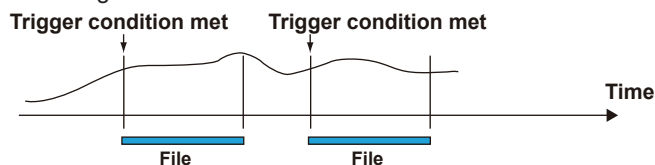

■ Internal memory

The recorded measurement data is divided at a specific time interval (data length for event data and file save interval for display data) and saved to files.

If the internal memory is full or if the number of display data files and event data files exceeds 500 for the GM10-1 or 1000 for the GM10-2, files are overwritten from the oldest file.

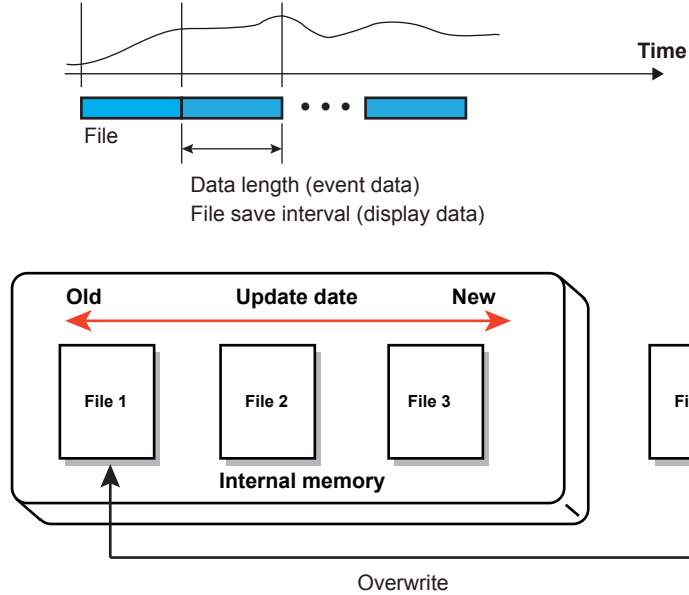

■ Recording Channels

Set the channels for recording the measurement data of event data, display data, and manual sampled data.

Only the channels assigned to recording channels are recorded as measurement data. You can select the channels to record from AI channels, DI channels, pulse input channels, DO channels, math channels (/MT option), and communication channels (/MC option).

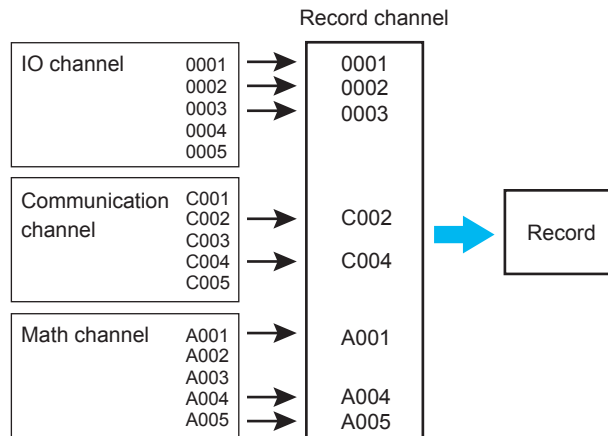

Number of recording channels

Data Type	Maximum Number of Recording Channels	
	GM10-1	GM10-2
Event data	500ch (250ch)*	1000ch (600ch)*
Display data	500ch (250ch)*	1000ch (600ch)*
Manual sample	50ch	100ch

* Numbers in parentheses are for when the measurement mode is set to Dual interval. The maximum number of channels that the GM can record varies depending on the recording interval and recording data type (for the GM10-2).

1.6.3 Output

The GM can output relay signals (digital output module or digital input/output module) when an alarm occurs, when a failure occurs, when they are manually turned on, or according to the event action function.

The output (DO channel) can also be recorded.

Digital output module

Module	Model	Output Type	Number of Channels
Digital output	GX90YD	Relay, SPDT(NO-C-NC)	6
Digital input/output	GX90WD	Relay, SPDT(NO-C-NC)	6

- **Alarm output**

When an alarm assigned to a measurement channel occurs, a relay signal is output from the DO channel that the alarm output is assigned to.

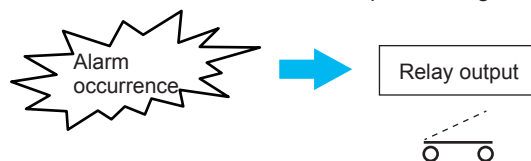

- **Manual output**

DO channels can be turned on and off through manual operation on the digital display screen shown in the Web browser.

To use manual output, the following settings are required.

- Set the DO channel type to Manual.
- In Display settings, set Value Modification from the Monitor to On.



- **Event action**

A relay signal is output when an event occurs.

For the events that can use relay output, see section page 1-34 in section 1.6.7, "Event Action Function".

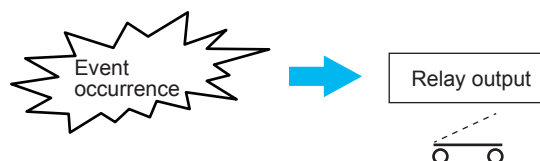

1.6.4 Storage

Measurement data saved in the internal memory can be saved in an external storage medium (SD card) automatically or manually.

■ Auto Save

Measurement data in the internal memory is saved automatically to an external storage medium (SD card).

Keep the SD card inserted in the drive at all times.

● Media FIFO Function

If not enough free space is available when saving a new data file to the SD card, files are deleted in order from the oldest data update date/time to save the new file. This operation is referred to as FIFO (first in first out).

When saving the data files automatically, you can save the data so that the most recent data files are constantly retained in the SD card. This method allows you to use the GM continuously without having to replace the SD card.

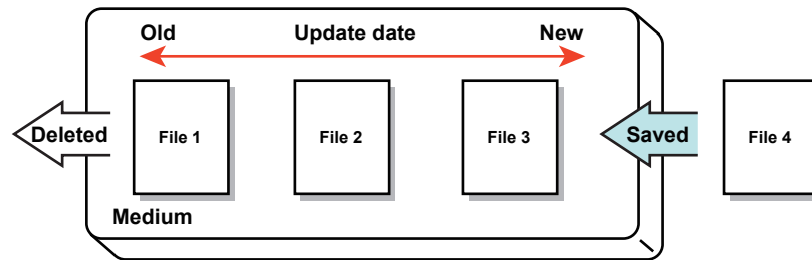

● Media FIFO Save Operation

- Up to the most recent 1000 files are retained. If the number of files in the save destination directory exceeds 1000, the number of files is held at 1000 by deleting old files even if there is enough free space.
- If there are more than 1000 files already in the save destination directory, at least one file is always deleted before saving the new file. The number of files is not kept within 1000 in this case.
- FIFO is used only when the following files are saved automatically. When files are saved using other methods, FIFO is not used.

Data File Types

Display data file
Event data file
Report data file
Manual sampled data file

■ Manual Save (Collectively Storing Unsaved Data)

If you do not use the auto save function, save measurement data manually.

Unsaved data in the internal memory is stored in files to the external storage medium (SD card) when an external storage medium is inserted.

When using manual save, you must be careful to save the data in the internal memory to the external storage medium before the data is overwritten.

■ **Measurement Data File Format**

Measurement data can be saved in binary or text format.

● **Binary format**

If security is a priority, save the measurement data in binary format.

It is extremely difficult to decipher or tamper binary data using a typical text editor or the like.

● **Text format**

If you want to directly open the data with a general-purpose text editor, spreadsheet application, or the like, save the data in text format. You will be able to edit the data without using a dedicated software application.

1.6.5 Display (Web browser)

Real time monitoring of measurement data is possible from a Web browser. You do not need to use a special software application.

You can also configure the GM and perform operations such as recording start/stop and computation start/stop.

■ **Monitoring**

You can monitor data being measured on the trend, digital, bar graph, overview, and other screens. In addition, past data can be displayed (historical trend).

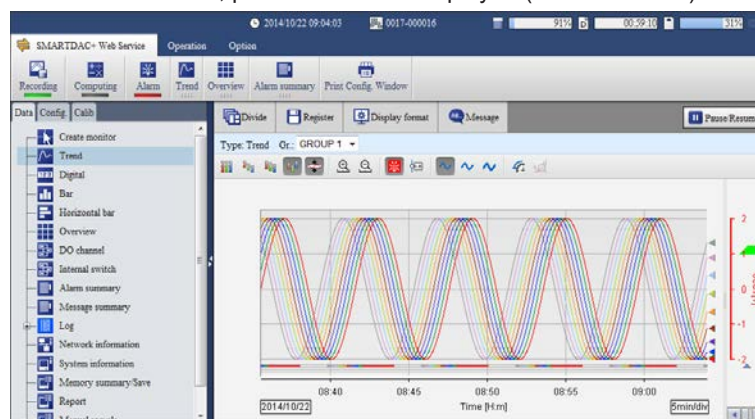

■ **Operation**

You can perform operations such as recording start/stop, computation start/stop, message writing, and manual sampling.

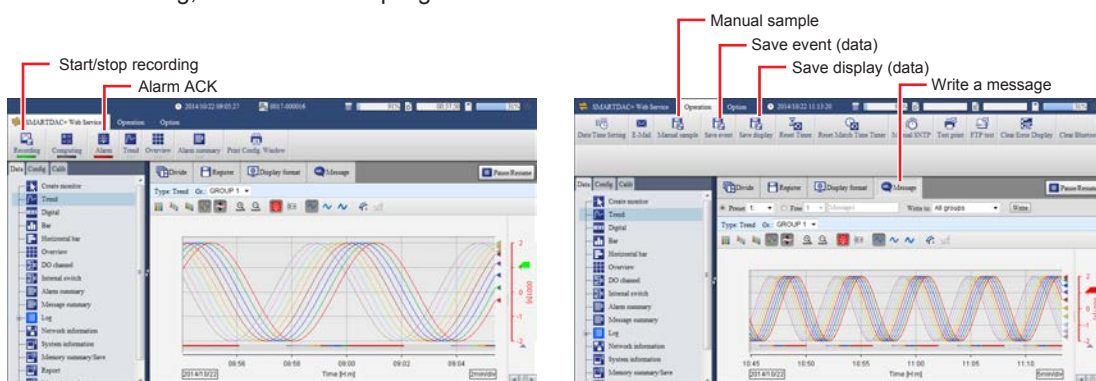

• **Message writing**

Messages can be written in event data and display data.

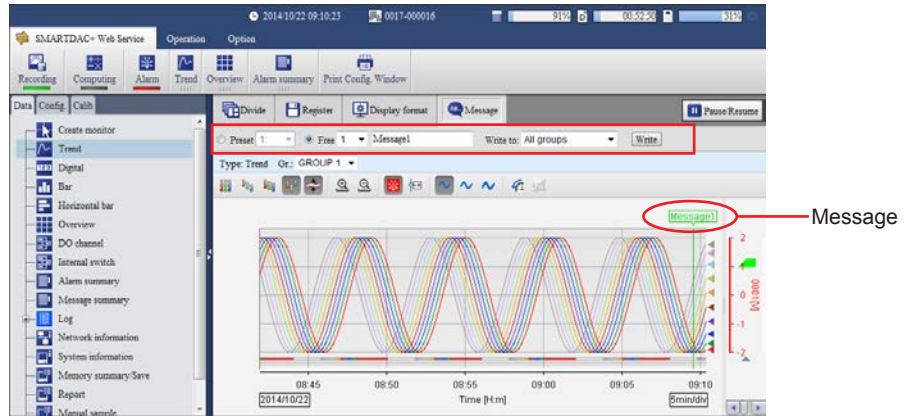

Types of messages that can be written

Message Type	Explanation
Preset message	You can write preset messages. Number of displayable characters: Up to 32 Up to 100 messages can be registered.
Free message	You can write messages that you enter freely. There are 10 free messages. The messages that you enter are registered in free messages 1 to 10.
Auto message	When the GM recovers from a power failure during recording, a fixed message is written.

■ **Configuration**

You can configure the GM from a Web browser.

When a configuration change occurs, you can simply switch to the Config. tab and change the settings; you do not have to use the configuration software.

In addition, you can perform system reconfiguration and A/D calibration from the Calib tab.

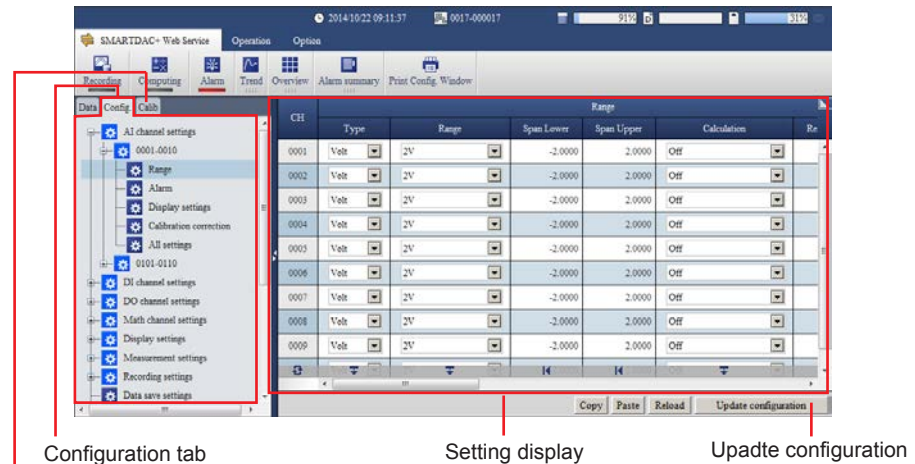

Configuration tab

Setting display

Upadte configuration



- Reconfiguration
- A/D calibration
- Advanced security settings
- Encryption/Certificate
- Multi batch settings
- Measurement mode
- Update

The following may be displayed depending on the available options.

- Advanced security settings (/AS option)
- Multi-batch settings (/BT option)

1.6.6 Various Functions

Alarm Function

For the measured values, up to four levels of alarms can be set on each channel.

Alarms can be output to relays and internal switches.

The alarm types that you can set vary depending on the channel type (input/output, math, communication).

■ Alarm Types

Type	Explanation
High limit (H)	<p>An alarm is activated when the measured value is greater than or equal to the alarm value.</p>
Lower limit (L)	<p>An alarm is activated when the measured value is less than or equal to the alarm value.</p>
High limit on rate-of-change (R)	<p>An alarm is activated if the increasing rate-of-change of measured values over a certain interval is greater than or equal to the specified value.</p>
Low limit on rate-of-change (r)	<p>An alarm is activated if the decreasing rate-of-change of measured values over a certain interval is greater than or equal to the specified value.</p>
Delay high limit (T)	<p>An alarm is activated if measured values remain greater than or equal to the alarm value for a specified time period (delay period).</p>
Delay low limit (t)	<p>An alarm is activated if measured values remain less than or equal to the alarm value for a specified time period (delay period).</p>
Difference high limit (h)	<p>An alarm is activated when the difference in the measured values of two channels is greater than or equal to the specified value. This alarm can be specified on measurement channels set to difference computation.</p>

Continued on next page

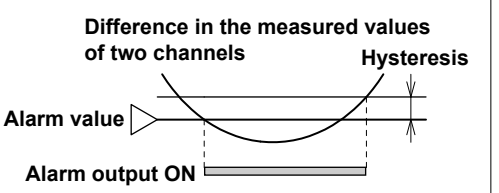
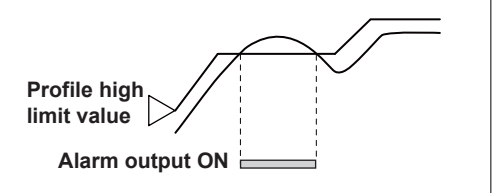
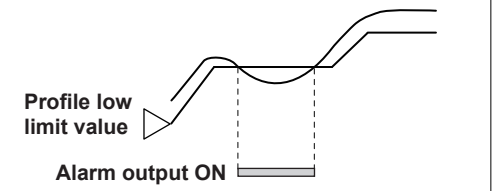
Type	Explanation	
Difference low limit (l)	An alarm is activated when the difference in the measured values of two channels is less than or equal to the specified value. This alarm can be specified on measurement channels set to difference computation.	
Profile high limit (F)	An alarm is activated when the measured value is greater than or equal to the profile trend high limit. You can set this when the profile trend is set to On.	
Profile low limit (f)	An alarm is activated when the measured value is less than or equal to the profile trend low limit. You can set this when the profile trend is set to On.	

The character inside the parentheses is the symbol denoting each alarm.

Alarm of a channel set to difference computation
It is set in the position shown in the figure below.

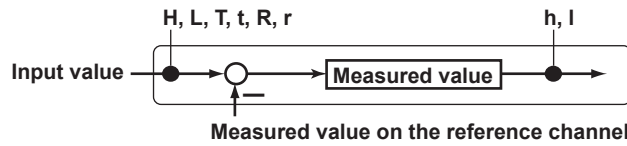

■ **Hysteresis**

You can furnish an offset between the value used to activate and release alarms. This is fixed at 0 for the DI range.

Example:

H: If you set the alarm value of a high limit alarm to 1.0000 V and the hysteresis to 0.0005 V, an alarm is activated when the measured value is greater than or equal to 1.0000 V and is released when the measured value is less than 0.9995 V.

■ **Alarm Display (Detection)**

You can select whether to display an alarm (indicate the occurrence) when an alarm occurs. If the alarm display is disabled, when an alarm occurs, the GM outputs signals to alarm output DO channels or internal switches but does not display the alarm. In addition, alarms are also not recorded in the alarm summary.

■ **Changing the Alarm Values from the Web Page**

You can change the alarm values from the Monitor Page (digital, bar graph, overview) on the Web browser.

This is useful when you need to change the alarm values depending on measurement conditions.

To use this function, in Display settings, under Screen display settings, Changing each value from monitoring must be set to On.

■ DO Output Operation

● AND/OR Operation

When multiple alarms are assigned to one alarm output relay, you can select which condition below will activate the output relay. You can also specify AND operation for internal switches.

- AND: Activated when all assigned alarms are occurring simultaneously
- OR: Activated when any of the specified alarms is occurring

● Reflash

When multiple alarms are assigned to one alarm output relay, this function notifies the occurrence of subsequent alarms after the relay is activated by the first alarm. When subsequent alarms occur, the output relay is released temporarily. The duration for which the relays are deactivated can be set to 500 ms, 1 s, or 2 s.

Relays set to Reflash will operate using OR and Nonhold settings.

● Energize or De-energize Operation

You can select whether the alarm output relay is energized or de-energized when an alarm occurs. If you select de-energize, the alarm output relays will be in the same state when the GM is shut down as they are when an alarm occurs.

● Non-hold/Hold

The alarm output relay can be set to operate in the following fashion when the alarm condition is no longer met.

- Turn OFF the relay output (nonhold).
- Hold the relay at ON until the alarm ACK is executed (hold).

● Alarm Acknowledge Operation (Alarm ACK)

Acknowledging All Alarms

Releases all alarm indications and relay outputs.

Individual Alarm ACK

You can release specific alarms.

In System settings, under Alarm basic settings, Individual Alarm ACK must be set to On.

■ DO Output Relay Operation

- ▶ See “DO Output Relay Operation” on page 2-66.

1.6.7 Event Action Function

The event action function is used to execute specified actions when certain events occur. It can also be used to perform remote control.

For example, you can have the GM write a message in the measurement data when an alarm occurs or start recording on a remote control input.

You can set up to 50 event actions (event action number 1 to 50).

■ Event Types

Item	Explanation
Remote (DI)	DI channel of remote control input
Relay (DO)	Relay status
Internal switch	Internal switch status
Alarm - IO channel	Alarm of an I/O channel
Alarm - Math channel	Alarm of a math channel
Alarm - Communication channel	Alarm of a communication channel
Any alarm	The change from no active alarms to one or more active alarms is regarded as an event.
Health score notification	An event that occurs when the health score falls to a negative value, or below the set early warning notification threshold.
Timer	Timer (timer 1 to 12) expiration
Match Time Timer	Match time timer (match time timer 1 to 12) expiration
User function key	User function key (USER1/USER2)
Status	Recording, math, memory/media error, measurement error, communication error

■ Action Types

Item	Explanation
Recording	Starts or stops recording.
Computation	Starts or stops computation (/MT option) or resets the computed values of all math channels.
Flag	Sets a flag to 1 (On) or 0 (Off). (/MT option)
Manual sample	Executes manual sampling
Alarm ACK	Clears the alarm output
Event trigger	Applies a trigger that starts event data recording. You can specify this when the GM is configured to event data.
Message writing	Writes a message. Specify the message number and the message write destination. Set the destination to all groups, or specify a write destination group number. You can execute this while recording is in progress.
Save event data	Saves the event data being recorded to a file in the internal memory. You can specify this when the GM is configured to event data.
Save display data	Saves the display data being recorded to a file in the internal memory. You can specify this when the GM is configured to record display data.
Reset the relative timer	Resets a relative timer. The timer starts immediately.
Load settings	Loads the setting parameter file from the root directory of the SD card and configures the GM accordingly.
Save settings	Saves the current setting parameters to the SD card.
Adjust the time	Sets the clock to the nearest hour.
Relay	Sets the relay output to On or Off.
Internal switch	Sets the internal switch to 1 (On) or 0 (Off).
Load program pattern	Loads all the pattern files (ProgPatYY, YY: 01 to 99) in the specified folder at the root directory of the SD memory card.
Load profile trend	Loads the specified files in the "Profile" folder at the root directory of the SD memory card.
Load predictive detection model	Loads the specified files in the "Model" folder at the root directory of the SD memory card.

■ Possible Combinations of Events and Actions

The combinations that are indicated with ✓ marks in the table below can be used.

Action \ Event	Remote (DI) ³	Relay (DO)	Internal switch	Alarm - IO channel	Alarm - Math channel	Alarm - Communication channel	Any alarm	Health score notification	Timer	Match timer	User function key	Status
Recording	✓	✓	✓	✓	✓	✓	✓	✓	✓	✓	✓	
Recording start/stop ¹	✓	✓	✓	✓	✓	✓	✓					
Computation	✓	✓	✓	✓	✓	✓	✓	✓	✓	✓	✓	
Computation start/stop ¹	✓	✓	✓	✓	✓	✓	✓					
Manual sample	✓	✓	✓	✓	✓	✓	✓	✓	✓	✓	✓	
Alarm ACK	✓								✓	✓	✓	
Save display data	✓	✓	✓	✓	✓	✓	✓	✓	✓	✓	✓	
Save event data	✓	✓	✓	✓	✓	✓	✓	✓	✓	✓	✓	
Event trigger	✓	✓	✓	✓	✓	✓	✓		✓	✓	✓	
Message	✓	✓	✓	✓	✓	✓	✓	✓	✓	✓	✓	✓
Reset the relative timer	✓	✓	✓	✓	✓	✓	✓			✓	✓	
Load settings	✓										✓	
Save settings	✓										✓	
Load program pattern	✓										✓	
Adjust the time	✓											
Flag	✓	✓	✓	✓	✓	✓	✓	✓	✓	✓	✓	✓
Flag On/Off ¹	✓	✓	✓	✓	✓	✓	✓					✓
Relay output ²	✓		✓					✓	✓	✓	✓	✓
Relay On/Off ^{1,2}	✓		✓									✓
Internal switch ²	✓	✓						✓	✓	✓	✓	✓
Internal switch On/Off ^{1,3}	✓	✓										✓
Load profile trend	✓										✓	
Load predictive detection model	✓										✓	
Predictive detection section	✓	✓	✓	✓	✓	✓	✓		✓	✓	✓	
HOLD profile trend	✓	✓	✓	✓	✓	✓	✓		✓	✓	✓	
Predictive detection section start/stop ¹	✓	✓	✓	✓	✓	✓	✓					
HOLD profile trend On/Off ¹	✓	✓	✓	✓	✓	✓	✓					

1 When the operation mode is rising/falling edge.

2 Action can be set to Relay output, Relay On/Off, Internal switch, or Internal switch On/Off only when the DO channel range type and internal switch type is set to Manual.

3 Only for DI modules installed in the GM whose operation mode is set to Remote.

■ Event Action Examples

No.	Event Action Description	Event	Action	Other Settings
1	Start and stop recording through remote control.	Remote	Recording start/stop	DI module operation mode: Remote
2	Write a message when an alarm occurs.	Alarm - IO channel	Message	
3	Save event data every day at hour 17.	Match time timer	Save event data	Match time timer setting Timer match condition: 17:00 Timer action: Repeat

1.6.8 Control Event Action Function

The control event action function is used to execute a specified action when certain events occur.

For details, see the *Loop Control Function, Program Control Function (/PG Option) User's Manual* (IM 04L51B01-31EN).

• Control Operation

Loop Control and Common Control

Function	Description
Run all control loops	Starts running all loops when the input changes from off to on.
Stop all control loops	Stops all loops when the input changes from off to on.
Control operation stop/start (specified loop)	Stops the control operation of specified loops when the input changes from off to on. Starts the control operation of specified loops when the input changes from on to off.
Auto/manual switch (specified loop)	Switches the control operation of specified loops to auto when the input changes from off to on. Switches the control operation of specified loops to manual when the input changes from on to off.
Remote/local switch (specified loop)	Switches the control operation of specified loops to remote when the input changes from off to on. Switches the control operation of specified loops to local when the input changes from on to off.
Auto switch (specified loop)	Switches the control operation of specified loops to auto when the input changes from off to on.
Manual switch (specified loop)	Switches the control operation of specified loops to manual when the input changes from off to on.
Cascade switch (specified loop)	Switches the control operation of specified loops to cascade when the input changes from off to on (during cascade control).
Remote switch (specified loop)	Switches the control operation of specified loops to remote when the input changes from off to on.
Local switch (specified loop)	Switches the control operation of specified loops to local when the input changes from off to on.
SP number switch (binary/BCD)	Switches the SP number according to the combination of input ON/OFF states (binary or BCD).

Program Control

Function	Description
Program RUN/RESET switch	Starts program operation when the input changes from off to on. Stops program operation when the input changes from on to off.
Hold operation	Pauses the operation of program patterns when the input changes from on to off.
Advance operation	Advances the operation of program patterns by one segment when the input changes from on to off.
Start of program operation	Starts program operation when the input changes from off to on.
Stop of program operation	Stops program operation when the input changes from off to on.
Hold operation (specified loop, specified program pattern)	Pauses the operation of the specified program pattern of the specified loop when the input changes from on to off.
Advance operation (specified loop, specified program pattern)	Advances the operation of the specified program pattern of the specified loop by one segment when the input changes from on to off.
Start of program operation (specified loop, specified program pattern)	Starts the operation of the specified program pattern of the specified loop when the input changes from on to off.
Stop of program operation (specified loop, specified program pattern)	Stops the operation of the specified program pattern of the specified loop when the input changes from on to off.
Program pattern number switch (binary/BCD selection)	Switches the program pattern number according to the combination of input ON/OFF states (binary or BCD).

- **Notification and Monitoring**

Control status monitoring parameters and notifications (events) are output to DO or internal switches (as actions).

Function	Description
Control status (RUN/STOP)	Outputs the control status (RUN status: ON, STOP status: OFF).
Wait end signal (1s, 3s, 5s)	Outputs an ON state signal for 1, 3, or 5 seconds when the program operation wait state ends.
Pattern end signal (1s, 3s, 5s)	Outputs an ON state signal for 1, 3, or 5 seconds when the program operation ends.
PV event status	Outputs an ON state signal while a PV event is occurring during program operation.
Time event status	Outputs an ON state signal while a time event is occurring during program operation.
Wait flag	Outputs an ON state signal while the program operation is waiting.
Hold-on flag	Outputs an ON state signal while the program operation is being held.
Program operation mode monitoring (STOP/RUN)	Outputs the program operation status (RUN: ON, STOP: OFF)
Segment number monitoring (binary/BCD)	Outputs the running segment number in binary or BCD ON/OFF states.
Pattern number monitoring (binary/BCD)	Outputs the running pattern number in binary or BCD ON/OFF states.

* The behavior varies depending on the energize/de-energize state of the contact type.

1.6.9 Batch Function

You can attach batch information to event data files and display data files. You can manage event data and display data files using batch information.

At the start of recording, batch number, lot number (when in use), and comments (1 to 3) are entered.

Each comment can be entered once during recording.

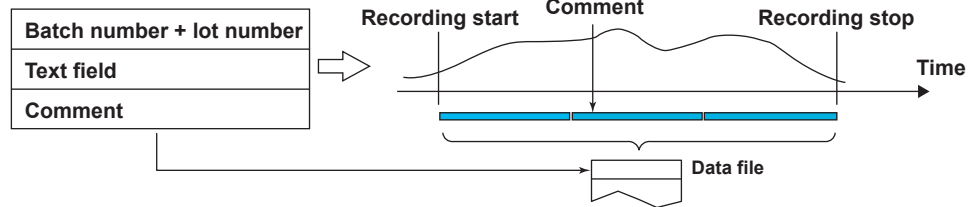

• **Batch Information**

Item	Explanation	
Batch No.	Up to 32 characters, Aa#1	
Lot No.	Lot numbers can be set to not use, 4 digits, 6 digits, or 8 digits.	
Comments 1 to 3	Up to 50 characters each, Aa#1 You can insert each comment once during recording.	
Textfield	Up to 24 fields can be set.	
	Title	Up to 20 characters, Aa#1
	Label	Up to 30 characters, Aa#1

• **Auto Increment Function**

Automatically sets the lot number of the next measurement to the current lot number + 1.

• **Batch Information Attached to Measurement Data**

The following figures show a display example of batch information attached to measurement data using Universal Viewer.

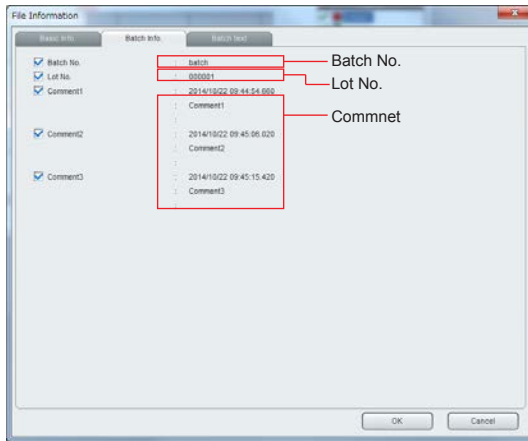

Batch information

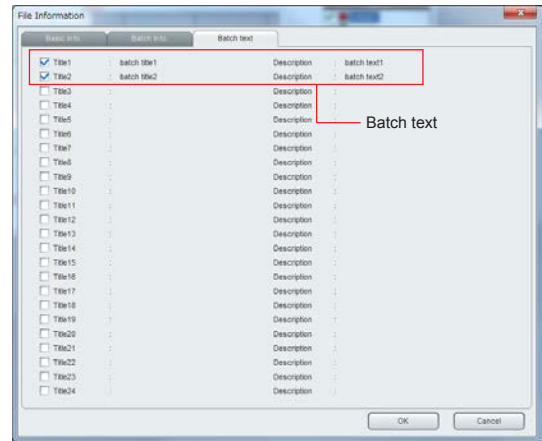

Batch text

1.6.10 Math Function (/MT option)

You can define expressions using measured data, computed data, and the like as variables, compute the expressions, and display and save the results. You can set up to 200 math channels.

■ Computation Types

Classification	Operator	Syntax	Explanation
Basic arithmetic	+	a+b	Determines the sum of a and b
	-	a-b	Determines the difference between a and b
	*	a*b	Determines the product of a and b
	/	a/b	Determines the quotient of a and b.
Basic operation	ABS()	ABS(a)	Determines the absolute value of a
	SQR()	SQR(a)	Determines the square root of a
	LOG()	LOG(a)	Determines the common logarithm (log ₁₀) of a
	LN()	LN(a)	Determines the natural logarithm of a
	EXP()	EXP(a)	Determines the exponent of a
	**	a**b	Determines a to the power of b
Relation operator	.GT. (or >)	a.GT.b (or a>b)	The computed result is 1 when a is greater than b. Otherwise, the result is 0.
	.LT. (or <)	a.LT.b (or a<b)	The computed result is 1 when a is less than b. Otherwise, the result is 0.
	.GE. (or >=)	a.GE.b (or a>=b)	The computed result is 1 when a is greater than or equal to b. Otherwise, the result is 0.
	.LE. (or <=)	a.LE.b (or a<=b)	The computed result is 1 when a is less than or equal to b. Otherwise, the result is 0.
	.EQ. (or =)	a.EQ.b (or a=b)	The computed result is 1 when a is equal to b. Otherwise, the result is 0.
	.NE. (or <>)	a.NE.b (or a<>b)	The computed result is 1 when a is not equal to b. Otherwise, the result is 0.
Logical operator	AND	e1ANDe2	If the two data values e1 and e2 are both non-zeros, the computed result is 1. Otherwise, it is 0. (The logical product is determined.)
	OR	e1ORe2	If the two data values e1 and e2 are both zeros, the computed result is 0. Otherwise, it is 1. (The logical sum is determined.)
	XOR	e1XORe2	If the two data values e1 and e2 are zero and non-zero or non-zero and zero, the computed result is 1. Otherwise, it is 0. (The exclusive logical sum is determined.)
	NOT	NOTe1	The result is the inverse of the status of data e1 (zero or non-zero). (The logical negation is determined.)
Statistical operations	TLOG.MAX()	TLOG.MAX(e1)	Determines the maximum value of the specified channel (e1).
	TLOG.MIN()	TLOG.MIN(e1)	Determines the minimum value of the specified channel (e1).
	TLOG.AVE()	TLOG.AVE(e1)	Determines the average value of the specified channel (e1).
	TLOG.SUM()	TLOG.SUM(e1)	Determines the sum of the specified channel (e1).
	TLOG.PSUM()	TLOG.PSUM(e1)	Determines the sum of the specified channel (e1).
	TLOG.P-P()	TLOG.P-P(e1)	Determines the maximum - minimum value of the specified channel (e1).
	CLOG.MAX()	CLOG.MAX(e1. e2.e4-e6)	Determines the maximum value among the specified group of channels (e1, e2, e4, e5, e6).
	CLOG.MIN()	CLOG.MIN(e1.e2.e4-e6)	Determines the minimum value among the specified group of channels (e1, e2, e4, e5, e6).
	CLOG.AVE()	CLOG.AVE(e1.e2.e4-e6)	Determines the average value among the specified group of channels (e1, e2, e4, e5, e6).
	CLOG.SUM()	CLOG.SUM(e1. e2.e4-e6)	Determines the sum among the specified group of channels (e1, e2, e4, e5, e6).
	CLOG.P-P()	CLOG.P-P(e1.e2.e4-e6)	Determines the maximum - minimum value among the specified group of channels (e1, e2, e4, e5, e6).

Continued on next page

Classification	Operator	Syntax	Explanation
Special operation	PRE()	PRE(e1)	Determines the previous value of e1.
	HOLD()	HOLD(a):b	When a is zero, b is carried out to derive the computed value. Otherwise, the previous computed value is held.
	RESET()	RESET(a):b	When a is zero, b is carried out to derive the computed value. Otherwise, the previous computed value of b is reset, and b is carried out to derive the computed value.
	CARRY()	CARRY(a):b	Only TLOG.SUM can be specified for b. If the computed value X of b is less than a, the computed result is X. If X is greater than or equal to a, the computed result is the excess (X – a).
Conditional expression	[a?b:c]	[a?b:c]	If the value of expression a is true, expression b is executed; otherwise expression c is executed.
Remainder extracting operation	.MOD.	a.MOD.b	Determines the remainder when a is divided by b.
Integer extracting operation	INT()	INT(a)	Determines the maximum integer that does not exceed a
Trigonometric function	SIN()	SIN(a)	Determines the sine value assuming the data of a to be an angle in degrees.
	COS()	COS(a)	Determines the cosine value assuming the data of a to be an angle in degrees.
Bit output	BIT.Bnn(a)		Outputs the value of the specified bit (Bnn) from bit data a (positive integer)
Recording status	REC1	REC1	Set to 1 if recording is in progress and 0 if recording is stopped.

■ Data That Can Be Used in Expressions

Data	Range
I/O channel data	0001 to 6950
Math channel data (/MT)	GM10-1: A001 to A100 GM10-2: A001 to A200
Constant	K001 to K100
Variable constant	W001 to W100
Communication channel data (/MC)	GM10-1: C001 to C300 GM10-2: C001 to C500
	Raw data GM10-1: RC001 to RC300 GM10-2: RC001 to RC500
Internal switch status	S001 to S100
Flag	F01 to F20
Recording status	REC1
Integer data	Z000 to Z999

1.6.11 Logic Math Function

Logic math is a function that outputs calculated results as 0 or 1 to relays (DOs) or internal switches. Up to 50 logic math operations can be set.

■ Computation Types

Type	Computing Element
Auxiliary operation	+, -
Basic arithmetic	+, -, *, /
Relational operation	.GT., .GE., .LT., .LE., .EQ., .NE., >, >=, <, <=, =, <>
Logical operation	AND, OR, NOT, XOR
Conditional operation	[expression 1 ? expression 2 : expression 3]
Bit operation	BIT.Bnn()

1.6.12 Report Function (/MT option)

The report function can be used to create a variety of report files from the measured data of I/O channels, math channels, and communication channels.

You can set up to 60 report channels. You can set up to five computation types.

You can select whether to save report files separately for each kind of report or two kinds of reports in a single file.

Time of creation: 10:00

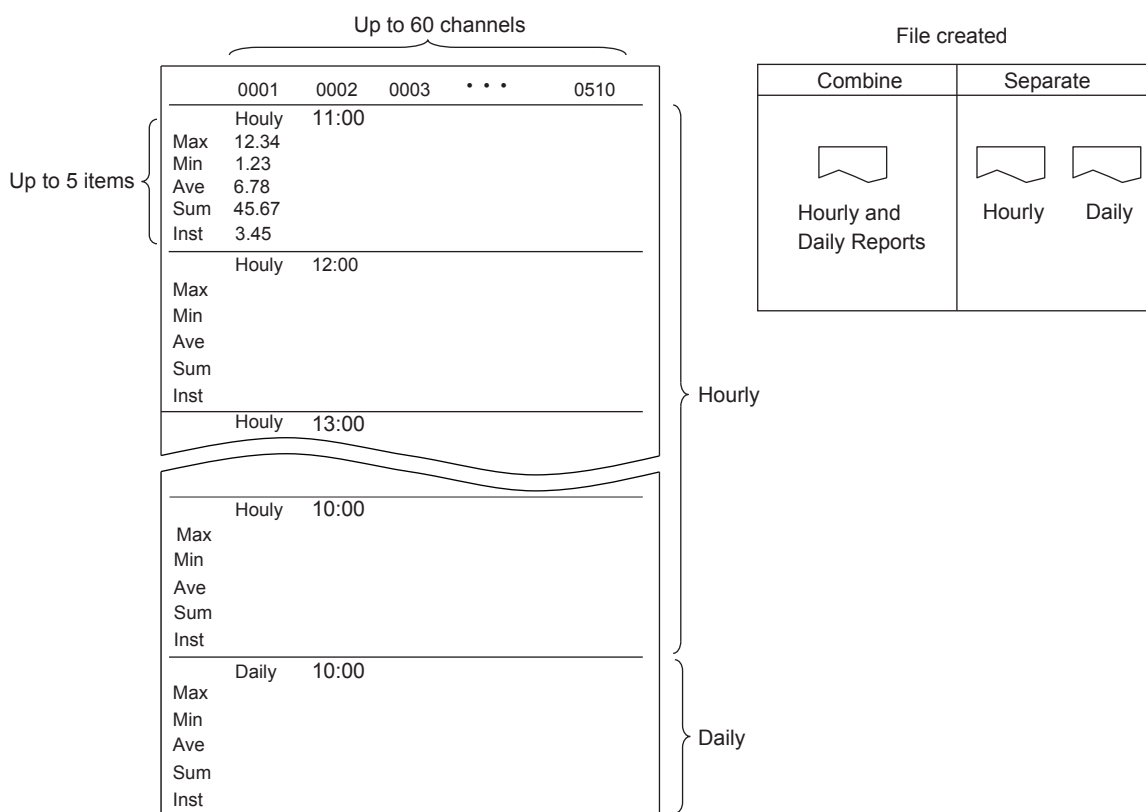

Example of a single file (Combine) containing Daily+Hourly

• **Report Kind**

Item	Explanation
Hourly + Daily	Creates hourly and daily reports. Hourly report: Creates report data every hour on the hour for the previous one hour. Daily report: Creates report data every day at a specified time for the previous one day.
Daily + Weekly	Creates hourly and weekly reports. Weekly report: Creates report data every week at a specified time at a specified day of the week for the previous one week.
Daily + Monthly	Monthly report: Creates report data every month at a specified time at a specified day for the previous one month.
Batch	Creates a report in unit of batches.
Daily custom	Creates daily reports by dividing it at the specified time intervals.

• **Computation Types**

Item	Explanation
Ave	Outputs average values.
Max	Outputs maximum values.
Min	Outputs minimum values.
Sum	Outputs sum values.
Inst	Outputs instantaneous values.

1.6.13 Report Template Function

You can create report templates and use them to automatically create custom report files. Load a report template file that you have created into the GM internal memory. The GM will automatically create report files using the report template file.

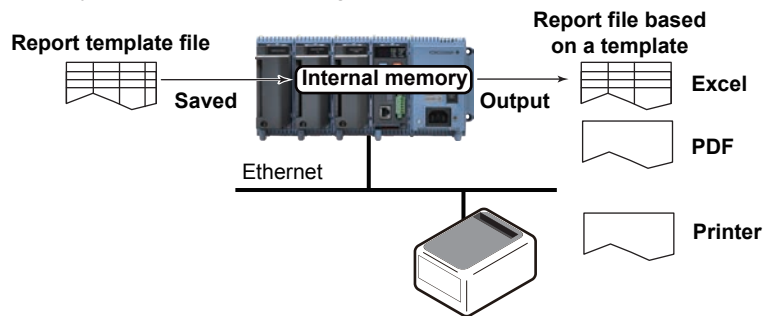

• **Files Created by Using Report Template Files**

Report File	Template	Explanation
Report files in Excel format	Excel format	A report template for each kind of report file is created.
Report files in PDF format	Yokogawa proprietary format	For each kind of report file, a corresponding report template file is used to create the appropriate report files.
Report output to printer	Yokogawa proprietary format	The report template file for PDF reports is used to output data to the printer.

● **Creating Report Templates for PDF Report Files and Printer Output**

To create a report template, use the editing tool provided by YOKOGAWA to enter keywords and text in the cells of table. Keywords specify the type of data that will be entered into a cell. Text are output as they are in reports. You can download creation tool from the following URL.
<http://www.smartdacplus.com/en/>

1.6.14 Security Function

The security function consists of the following functions.

- Login
- User privileges
- Key lock

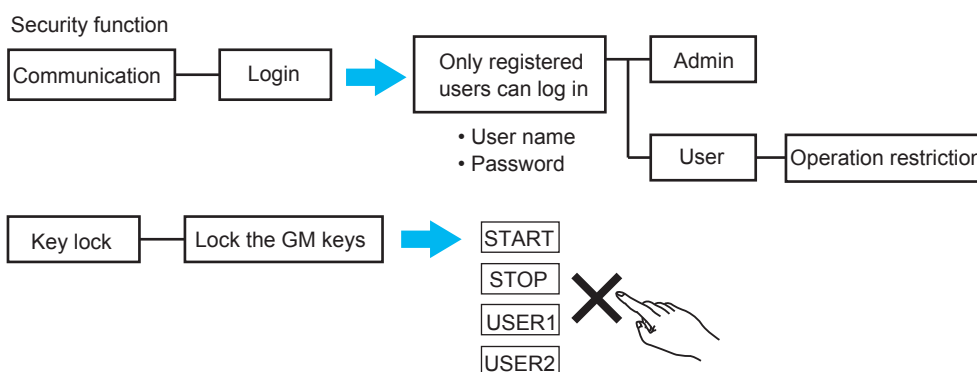

■ **Login**

Only registered users (administrators and users) can log in to the GM to perform monitoring and operation.

● **User Levels**

User Level	Explanation
Administrator (Admin)	An administrator can perform all GM operations.
User	Authority of user can be configured to restrict the items that users are allowed to use. A user cannot configure security settings.

● **Number of User Registrations**

Up to 50 users including administrators (user numbers 1 to 50) can be registered. User number 1 is fixed as an administrator.

● **Login Method**

Registered users log in to GM by entering their user names and passwords.

■ **User Privileges**

Limitations can be applied to the operations that a user can perform. Up to 10 conditions of operation limitations can be set (authority numbers 1 to 10). For each user, you can set whether to apply user limitations and the conditions to be applied.

Operation limitations

Operation	Explanation
Recording	Restricts record start/stop operation.
Computation	Restricts math start, math stop, and math reset operations.
Data save	Restricts the operations to save display data, save event data, generate event triggers, manual sample, snapshot, reset timer, and reset match time timer.
Message	Restricts message writing operations.
Batch	Restricts batch number writing, lot number writing, comment writing, and text field writing, predictive detection section start, stop, hold.
Alarm ACK	Restrict alarm ACK operations.
Communication	Restricts the operations to start, stop, and test mail; test FTP, get and release network information; test printer output; manually recover Modbus master; and manually recover Modbus client.
Time set	Restricts manual SNTP server time adjustment, date / time setting operations, and time related setting operations (time zone setting, gradual time adjustment operation setting, daylight saving time setting).
Setting operation	Restricts setting operations.
External storage medium	Restricts the operations to save, load, and delete files; manually save data; save alarms; abort saving; create certificate signature requests; install certificates; install intermediate certificates; health monitor save.
System operation	Restricts the operations to initialize; reconfigure system; encrypt; manage, display, and delete certificates; and execute unverified certificates.
Output operation	Restricts internal switch operations, relay operations, and AO channel operations (retransmission output, manual output).

■ **Key Lock**

The GM10 (Data Acquisition Module) keys (START, STOP, USER1, USER2) can be locked.



1.6.15 Fail, Status Output

CPU errors (FAIL) and status can be output as relay signals.

You can select which status to output from event action.

To output relay signals, you need a digital output module (GX90YD) or digital input/output module (GX90WD).

Device information	Description	Details	
Device status	Recording	A relay signal is output when recording starts.	-----
	Math	A relay signal is output when computation starts.	-----
	User lock out	A relay signal is output when a user lockout occurs.	-----
	Memory/media error	A relay signal is output when an error occurs in the internal memory or external storage medium.	Error in the internal memory. Error in the external storage media.
	Measurement error	A relay signal is output when a measurement error occurs.	Error in the A/D converter. A burnout was detected. This occurs when thermocouple or RTD wires are disconnected or when general signals are outside the specifications. Module error was detected.
	Communication error	A relay signal is output when a communication error occurs.	A communication error occurred in the Modbus master, Modbus client, WT communication (/E2 option), or SLMP communication (/E4 option).
Alarm	A relay signal is output when an alarm occurs. However, alarms that are set not to display their occurrence are not output to the relay.	-----	

- ▶ For details on the fail function, see page 2-63 in section 2.7, “Configuring DO Channels (Digital output channels)”.
- ▶ For details on the status output, see page 2-135 in section 2.20, “Configuring the Event Action Function”.

1.6.16 Timer and Internal Switch Functions

■ Timers

Timers are used in event action and computation (/MT option). There are two types of timers: absolute and relative. You can set up to 12 timers for each type.

● Absolute Timer

The timer expires at the times determined by the reference time and the interval. The reference time is set on the hour (00 to 23).

Absolute timer

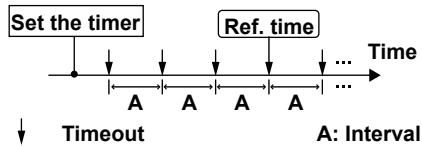

Example: Reference time: 00:00
Interval: 10 minutes

The timer expires at 0 hour, 0 hour 10 min, 0 hour 20 min, . . . 23 hour 40 min, and 23 hour 50 min.

For example, if the timer is set at 9 hour 36 min, the timer expires at 09 hour 40 min, 09 hour 50 min, 10 hour, and so on.

● Relative Timer

The timer is started when the timer is set, and the timer expires every specified interval. In this mode, the timer stops when a power failure occurs.

Relative timer

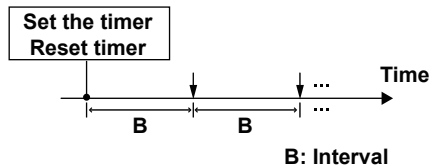

Example: Interval: 15
The timer expires every 15 minutes.

■ Internal Switches

The GM has 100 internal switches (S001 to S100).

You can use them as output destinations for calculation expressions and alarms.

1.6.17 Log Scale Function (/LG option)

A logarithmic voltage that has been converted from a physical value is applied to the GM, and then the GM's Log scale (logarithmic scale) is used to display and record the physical value.

■ Input Type

The GM supports the following three types of input signals.

● Logarithmic Input

This is referred to as "Log input." It is an input in which voltages correspond to logarithmic values of physical values.

● Pseudo Log Input

This input supports pseudo logs.

A pseudo log signal is a voltage obtained by summing the one's digit of the voltage representing the exponent of the logarithmic data and the decimal digits of the voltage representing the mantissa.

● Input That Is Linear on a Logarithmic Scale

This is referred to as "Log linear input." Log linear input is input in which the voltage values correspond to the logarithmic values of physical values at each decade division (e.g., 1×10^2) and in which, within each decade, the voltage values correspond linearly to physical values.

■ Display

The trend display (Web browser) shows waveforms with the Log scale. Digital values are displayed as exponents (e.g., $1.2E+03$).

■ Alarms

● Alarm Values

Alarm values can be set in the range corresponding to -5% to 105% of the span width on the LOG scale. The mantissa range is 1.00 to 9.99 or 1.0 to 9.9 (depending on the decimal place setting).

● Alarm Types

You can set the following alarm types.

H: High limit, L: Low limit, T: Delay high limit, t: Delay low limit

■ Log Input (Nonlinear Log Input) Example

To support the nonlinear output of vacuum gauges, use the calibration correction function to correct the GM input values with linear approximation.

Conceptual diagram

The pressure scale is mapped to an input scale that has been multiplied by a constant number to derive the output scale.

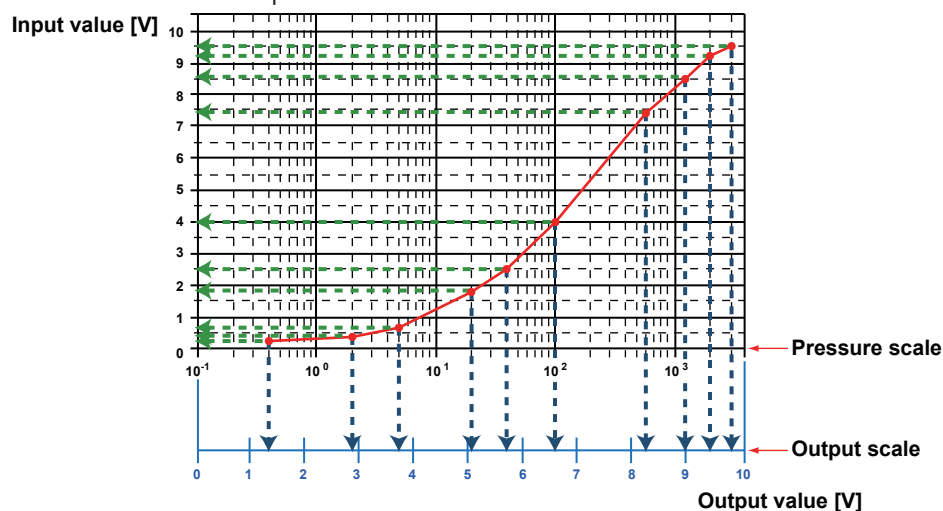

1.6.18 Communication and Network Functions

DHCP Function

IP parameters can be set automatically using DHCP.

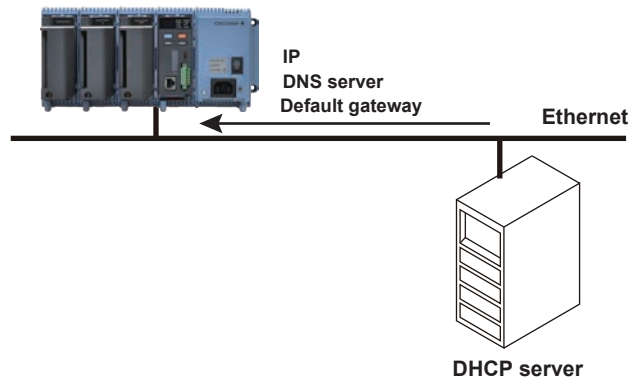

File Transfer Function (FTP)

The GM has FTP server and FTP client file transfer functions.

■ Server

You can use a PC to access the GM via FTP. You can perform operations such as retrieving directory and file lists from the external storage medium (SD card) of the GM and transferring and deleting files. In addition, you can also retrieve the directory or file list and transfer files in the internal memory.

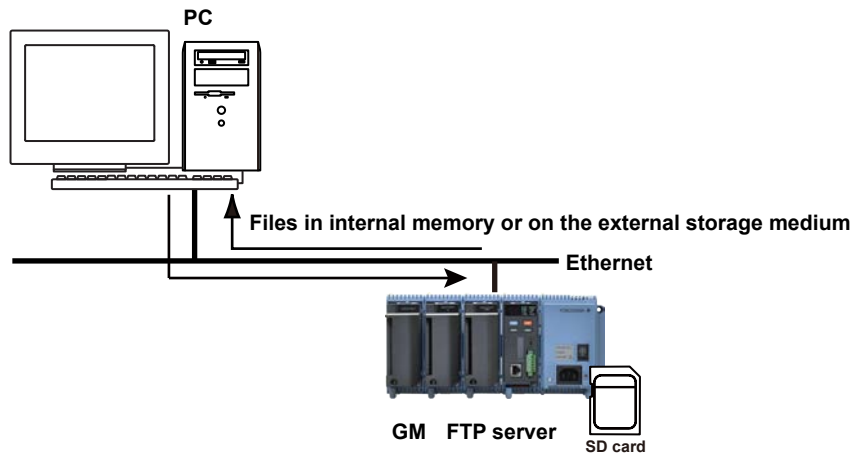

■ Client

The following files that are created in the internal memory of the GM can be automatically transferred using FTP when they are created.

File Type
Event data
Display data
Report data
Alarm summary data
Manual sampled data
Setting file (/AS)
Health monitor

● **File Transfer Destination (FTP server)**

You can specify two file transfer destinations (FTP servers): primary and secondary. If the primary server is down, the file is transferred to the secondary server. If the report template function is in use, report files in Excel format and report files in PDF format that are created in the external storage medium of the GM can be automatically transferred when they are created.

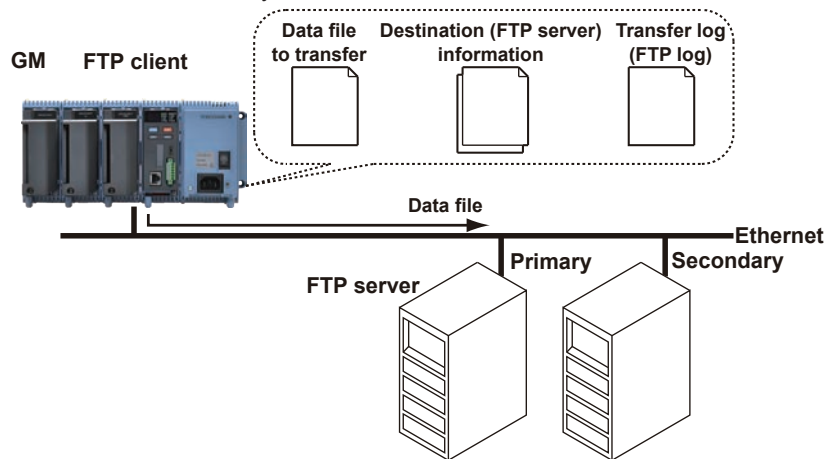

1.6.19 **SNTP Function**

■ **Client**

The GM time can be synchronized to the time on an SNTP server (time information server on the network). The GM can retrieve time information from a specified SNTP server at specified intervals.

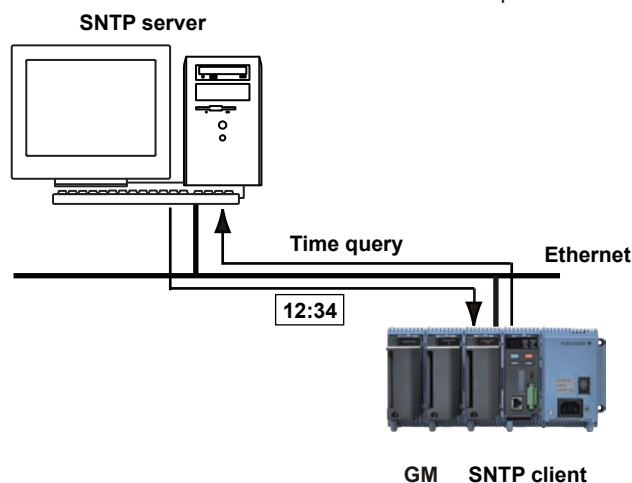

■ **Server**

The GM can operate as an SNTP server. When an SNTP client device on the network queries the GM for time information, the GM sends the information.

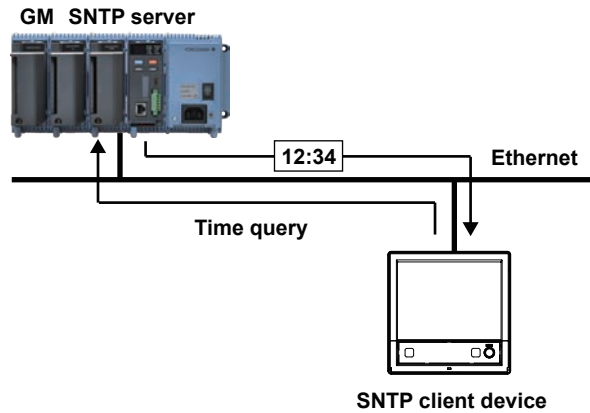

1.6.20 Mail Transfer Function (SMTP)

Mails can be transferred when alarms occur, when reports are created, and so on. You can set up to two destinations (recipient 1, recipient 2). You can also set multiple e-mail addresses in a single recipient (space-delimited).

● **Mail Transmission Conditions**

Classification	Item	Explanation
Alarms	Alarm notification	An e-mail is transmitted when an alarm occurs and when it is released. Instantaneous data can be included. The data that is included is the instantaneous value at the time of the e-mail transmission.
Report	Report notification	An e-mail is transmitted when a report is created.
Periodic	Scheduled notification	An e-mail is transmitted at the specified time. Instantaneous data can be included. The data that is included is the instantaneous value at the scheduled time.
System	Memory full notification	An e-mail is transmitted when the free space on the external storage medium or internal memory is low.
	Power failure notification	An e-mail is transmitted when the GM is powered on or recovers from a power failure.
	System error notification	An e-mail is transmitted when a system error occurs.
	User lockout notification (/AS)	An e-mail is transmitted when a user lockout (user Invalidation) occurs.
	Health score notification	An e-mail a health score notification.

Alarm detection channels

You can set up to 50 channels from I/O channels, math channels, and communication channels.

● **Authentication**

The following authentication methods are supported.

Authentication
SMTP Authentication
POP before SMTP
APOP

1.6.21 HTTP Function

You can access the GM from a Web browser and monitor measurement data in real time and configure and operate the GM.

For details, see page 1-29 in section 1.6.5, "Display (Web browser)".

1.6.22 Communication Channel Function (/MC option)

When data from Modbus devices or PC is recorded on the GM, the acquired data is assigned to communication channels (GM10-1: C001 to C300, GM10-2: C001 to C500). Data acquired from power meters using WT communication (/E2 option) is also assigned to communication channels.

Alarms can be set on communication channels.

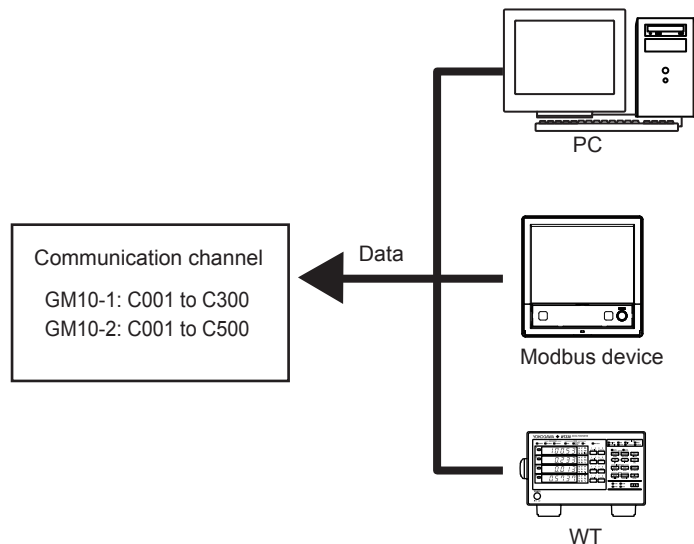

• Watchdog timer

Data may fail to be updated due to Modbus or other communication problems.

The watchdog timer function replaces values with their preset values or last values and when values are not updated within the specified duration (timer).

Data replacement occurs immediately when the timer expires, and the values are held until the next read cycle.

The watchdog timer is also useful for detecting communication interruptions caused by communication errors.

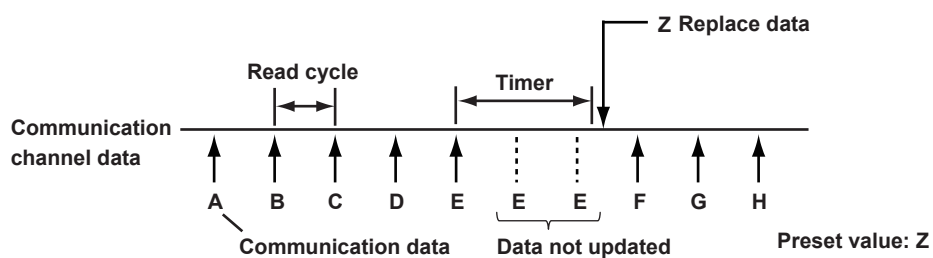

1.6.23 Modbus Function

The Modbus function is used by the GM and external Modbus devices to perform communication and data reading and writing.

The GM can perform the following operations.

Interface	Protocol	Function
Ethernet	Modbus/TCP	Modbus server
		Modbus client (/MC option)
RS-422/485	Modbus/RTU	Modbus slave
		Modbus master (/MC option)

■ Modbus Server/Slave Function

The GM can operate as a Modbus server or slave.

Modbus client or master devices can perform the following operations on the GM.

- Read I/O channel and math channel (/MT option) data
- Read communication channel (/MC option) data
- Write data to communication channels
- Start and stop recording, write messages, and perform other operations
- Load the recording start/stop condition, message strings, and other types of data
- Limit the IP addresses that can connect to the GM Modbus server function.

Client devices can transmit commands to the GM to read data from and write data to the GM internal registers. By writing data to the GM internal registers, you can control the GM (such as start recording).

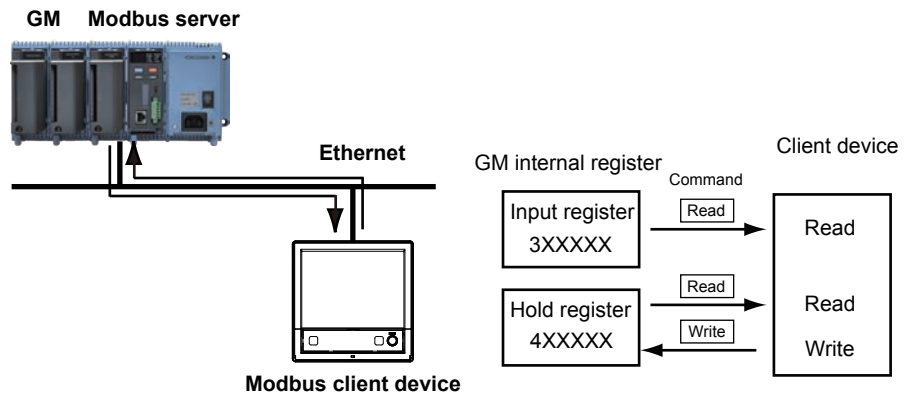

● Maximum Number of Client Connections When Operating as a Modbus Server

Type	Maximum Number of Client Connections
GM10-1	4
GM10-2	4

■ **Modbus Client/Master Function**

The GM can operate as a Modbus client or master. It can read from and write to the internal registers of Modbus server or slave devices. Read data can be assigned to communication channels (/MC) for processing.

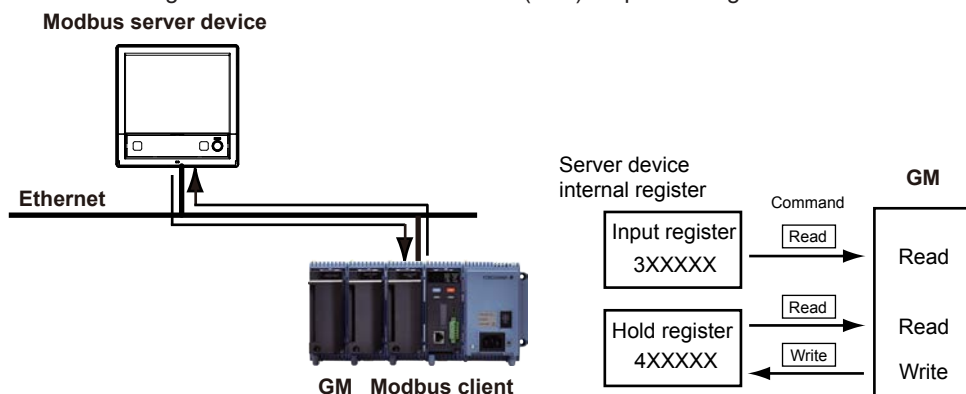

● **Number of Commands**

Type	Number of Commands
GM10-1	100
GM10-2	200 (Modbus client) 100 (Modbus master)

● **Maximum Number of Server Connections When Operating as a Modbus Client**

Type	Maximum Number of Server Connections
GM10-1	16
GM10-2	32

● **Writable Data**

Data Type
I/O channel data
Math channel data (/MT option)
Communication channel data (/MC option)

1.6.24 SSL Communication Function

Communication that sends and receives information encrypted by the SSL protocol is possible.

Public key encryption and certificate are used to encrypt communication and secure the connection.

SSL (Secure Sockets Layer)

SSL is a function for encrypting data communication between devices on the Internet and other networks. It ensures safe data transmission such as by preventing spoofing by other devices and data eavesdropping.

■ Supported Servers

HTTP server and FTP server are supported.

● HTTP Server Function

A certificate is saved in the internal memory in advance.

When a PC accesses the GM's Web server, the certificate is sent from the internal memory to the PC. Encrypted data is exchanged.

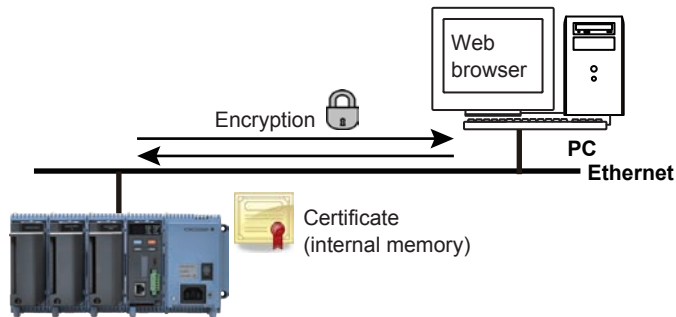

● FTP Server

A certificate is saved in the internal memory in advance.

When a PC accesses the GM's FTP server, the certificate is sent to the PC. Encrypted measurement data is exchanged.

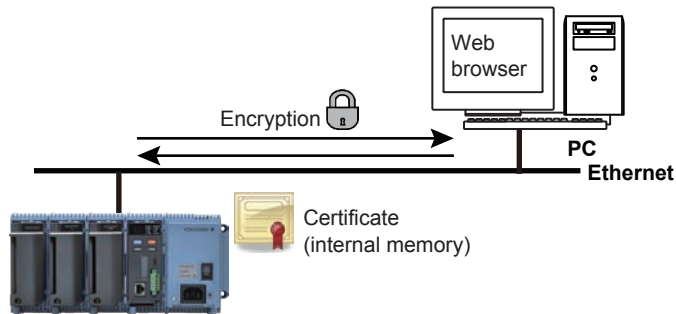

■ Supported Clients

FTP client and SMTP client are supported.

● FTP Client

A trusted certificate is saved in the internal memory in advance.

When an access is made to an FTP server, it compares the certificate received from the server to the one in the internal memory. Encrypted data is sent to the server.

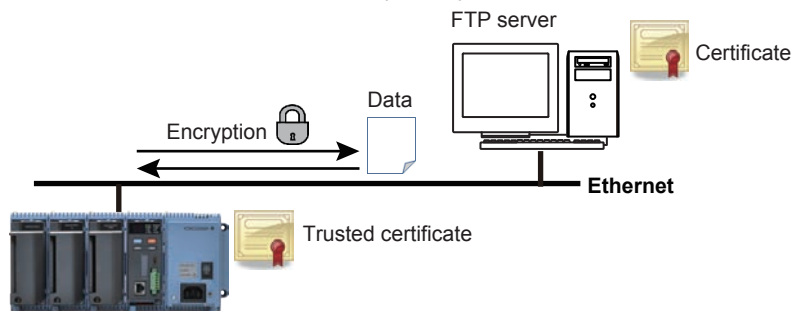

● SMTP Client

A trusted certificate is saved in the internal memory in advance.

When an access is made to an SMTP server, it compares the certificate received from the server to the one in the internal memory. Encrypted e-mail is sent to the server.

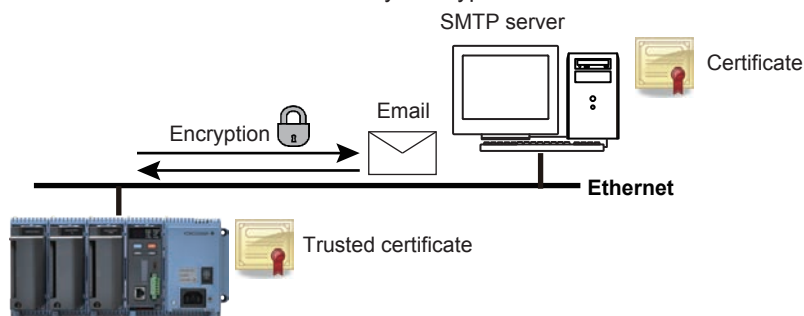

■ Trusted Certificate, Electronic Signature Function

● Trusted Certificate

Trusted certificates (up to 100KB total) can be saved in the internal memory.

Certificates received from servers can be compared to the ones in the internal memory.

● Electronic Signature Function

Electronic signatures can be added to report files created in PDF format using the PDF form creation function. Electronic signatures are applied when report files are created.

● Electronic Signature Certificate

Electronic signature certificates that users create can be saved in the internal memory.

1.6.25 DARWIN Compatible Communication

A portion of the DARWIN's setting and control commands is supported. Measured data, math data, and the like can be output in DARWIN format. You can use an existing program that has been created for DARWIN to communicate with the GM. Ethernet and RS-422/485 are supported.

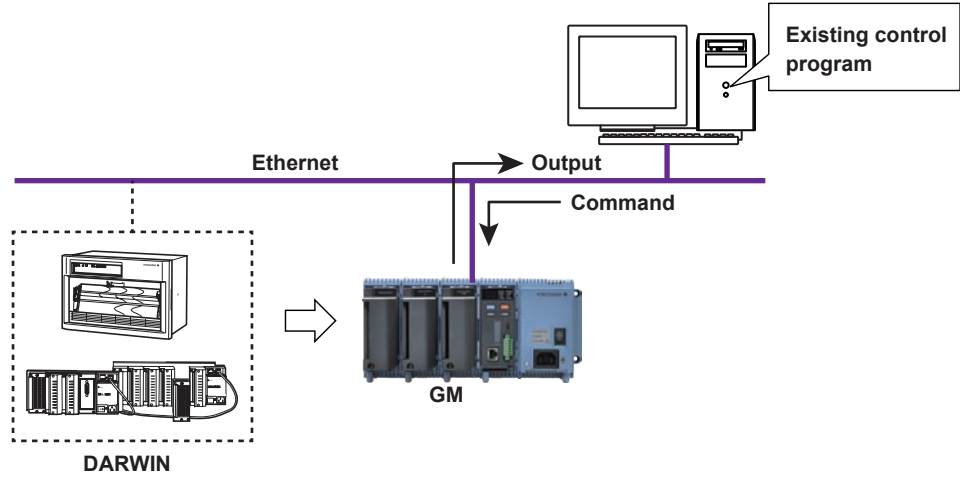

■ Supported Commands

● Instantaneous Data Output Commands

Command	Description
EF	Outputs measured data and math data in binary format.
EL	Outputs unit and decimal point information of a specified channel in ASCII format.
EB	Sets the byte output order.

DO, DIO, AO, and PID control modules cannot output measured data or decimal point information.

● ESC+T Command

If a "Esc+T" command is received, time-synchronized measured value and math value are held in the local buffer until the next "Esc+T" command is received.

Command	Description
Esc+T	Prepares to output the data selected with the TS command.

● Setting Commands

Command	Description
SR	Sets the range.
SN	Sets the unit (scale unit).
SA	Sets an alarm.
SC	Sets the chart speed.
SZ	Sets the zone recording.
PT	Sets the analog recording.
SD	Sets the date and time.
SV	Sets moving average.
AO	Assigns a reference channel to the retransmission output channel
CM	Sets math input data (option).

● Commands Applicable to RS-422/485 Only

Command	Description
ESC+O	Open Command (address a communication destination)
ESC+C	Close Command (close the addressed state of a device)

• Data Output Request Commands

Command	Parameter	Description
TS	0: Measured data	Selects the talker output data.
	1: Setting parameters	
	2: Unit information	
	5: System configuration information	
	9: Setup mode setting parameter output	
FM	0: Measured data (ASCII)	Selects the output format of measured/math data.
	1: Math data (binary)	
	2: Math data (ASCII)	
	3: Math channel (binary)	
LF	—	Sets the output channel for the setting parameter output, unit, and decimal place information.
CF	—	Sets the system configuration data format.
VF	—	Relay status output request.
BO	—	Sets the byte output order.
ESC+S	—	Status output request

• Control Execution Commands

Command	Description
AR	Resets alarms.
IR	Resets timers.
EX	Starts, stops, resets, clears (option) math.
RS	System reconfiguration.
RC	Clears RAM (initializes operation mode setting parameters).
VD	Turns on and off relays externally.
CF	System configuration data output request (diagnosis)
PS	Starts or stops recording.
MS	Starts message printing.
IM	Sets the interrupt mask.
SM	Sets the auxiliary interrupt mask.

• Handling of Commands for Functions Not Available on the GM

If a command or parameter for a function not available on the GM is received, a negative response (E1) is returned.

However, if the command does not constitute a functional problem, a positive response (E0) is returned without performing any operation.

Commands That the GM Returns Positive Responses For

Command	Description	Response	Operation
DS	Switches the setting mode.	Positive response	No operation
XE	Confirms setup setting parameters.		
UD	Sets the display mode of the top display.		
ESC+R	Switch from Local Status to Remote Status.		
ESC+L	Switch from Remote Status to Local Status.		

Commands That Do Not Affect the Operation (Negative response)

Command	Description	Response	Operation
SX	Sets a math group.	Negative response	No effect
SI	Sets a timer (option).		
SQ	Sets a match time timer (option).		
SL	Sets event/action (option).		
SO	Sets a calculation expression (option).		
SK	Sets a calculation constant (option).		
AO	Assigns a transmission channel.		
YO	Sets the time constant for transmission output.		
ET	Sets a timeout.		

1.6.26 EtherNet/IP Function (/E1 option)

■ EtherNet/IP Overview

EtherNet/IP is a protocol that extends Common Industrial Protocol (CIP) to Ethernet. The use of Ethernet enables high-speed and periodic exchange of massive control and monitoring data between control devices placed at dispersed locations.

Devices that support EtherNet/IP are available from many vendors. Among them, Rockwell Automation’s Programmable Logic Controller (PLC) and Remote I/O of the Allen-Bradley brand are widely used. Yokogawa’s GM is equipped with the EtherNet/IP server function, supports communications with these PLCs.

■ GM Functions

The GM provides the following functions:

- Participate in an EtherNet/IP network as an Adapter (Server).
- Communicate with new and old Allen-Bradley PLCs such as MicroLogix, CompactLogix, ControlLogix, SLC 500, PLC-5, and PLC-2.
- Support both Explicit and I/O messages.

Explicit Message	Target PLC	Command Name
Explicit Message	PLC-2	PLC2 Unprotected Read/Write
	PLC-5	PLC5 Word Range Read/Write
	SLC	SLC Typed Read/Write

- PLCs can access internal data of the GM.

Data	Access
Input/Output channel data	Read
Computation channel ¹ data	Read
Communication channel ² data	Read/write

1 /MT option

2 /MC option

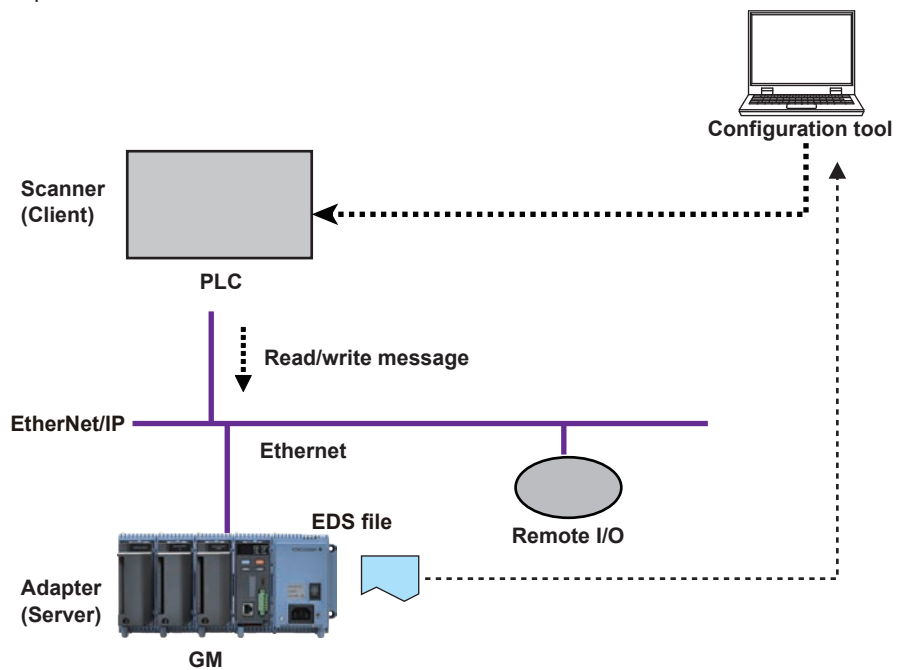

1.6.27 WT Communication Function (/E2 option)

The WT communication function is used by the GM to acquire values measured and computed on WT power meters and analyzers made by Yokogawa Meters & Instruments Corporation. The values are acquired in digital form over Ethernet.

The acquired data can be assigned to communication channels (/MC option) and displayed and recorded simultaneously with the measured temperature or other data of the GM.

Previously, the GM measured the D/A conversion output of power meters (measured values converted into analog signals). This was compromising the high-precision data that the power meters were measuring.

The WT communication function maintains high precision by acquiring the digital values.

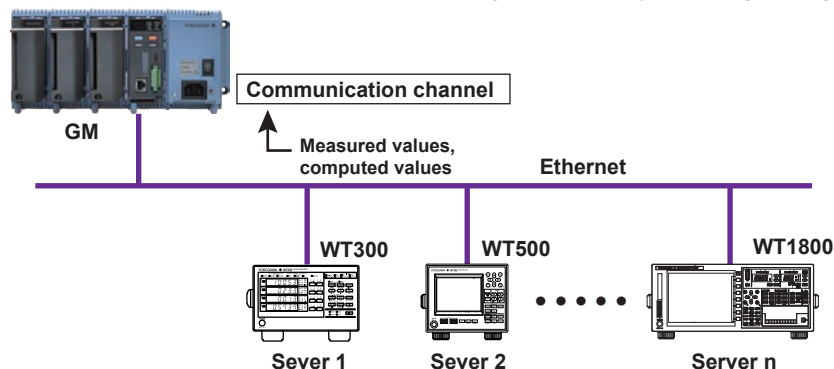

• Connectable Models and Options

Maker	Models	Option	Description
Yokogawa Meters & Instruments	WT310/WT330	/G5	Harmonic measurement
		/G6	Simultaneous dual harmonic measurement
	WT500	/G5	Harmonic measurement
		/DT	Delta computation
	WT1800	/G5	Harmonic measurement
		/G6	Simultaneous dual harmonic measurement
		/DT	Delta computation
		/MTR	Motor evaluation function
		/AUX	Auxiliary sensor inputs

• General Specifications

Item	Specifications
Maximum number of simultaneous connections	16
Data acquisition interval	500ms/1s/2s/5s/10s/20s/30s
Number of acquisition data assignments	300 (assigned to communication channels)

• Other Functions

Exponential scaling

Exponential scaling can be applied to data acquired from a WT.

For example, if the measured value of the WT is 123.45 kW, the data can be scaled by 10^{-3} to derive data in unit of kW.

Watchdog timer

The watchdog timer can be used to detect communication interruptions caused by communication errors.

For details on the watchdog timer function, see page 1-51 in section 1.6.22, "Communication Channel Function (/MC option)".

Status output

Notification can be sent through relay output when there is a WT communication error.

1.6.28 Bluetooth Function (/C8 option)

The Bluetooth function can be used to exchange setup data between a PC in which the Hardware Configurator is installed and the GM.

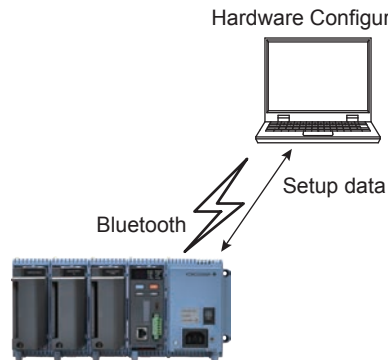

1.6.29 Measurement/Setting Server Function

Dedicated commands can be used to configure the GM, acquire data, and so on.

Supported interfaces

- Ethernet
- USB
- RS-422/485 (/C3)
- Bluetooth (/C8)

1.6.30 Advanced security function (/AS option)

This function makes the GM comply with FDA 21 CFR Part 11 (Electronic Records; Electronic Signatures). It enables the GM to be used in pharmaceutical production and other various applications that require strict security, data management, and electronic signatures. For details, see the Data Acquisition System GM Advanced Security (/AS) User's Manual.

1.6.31 Multi-batch Function (/BT option)

The multi-batch function allows you to record and save the measured data from multiple batches separately (per batch). You can also apply the multi-batch function to multiple consecutive processes.

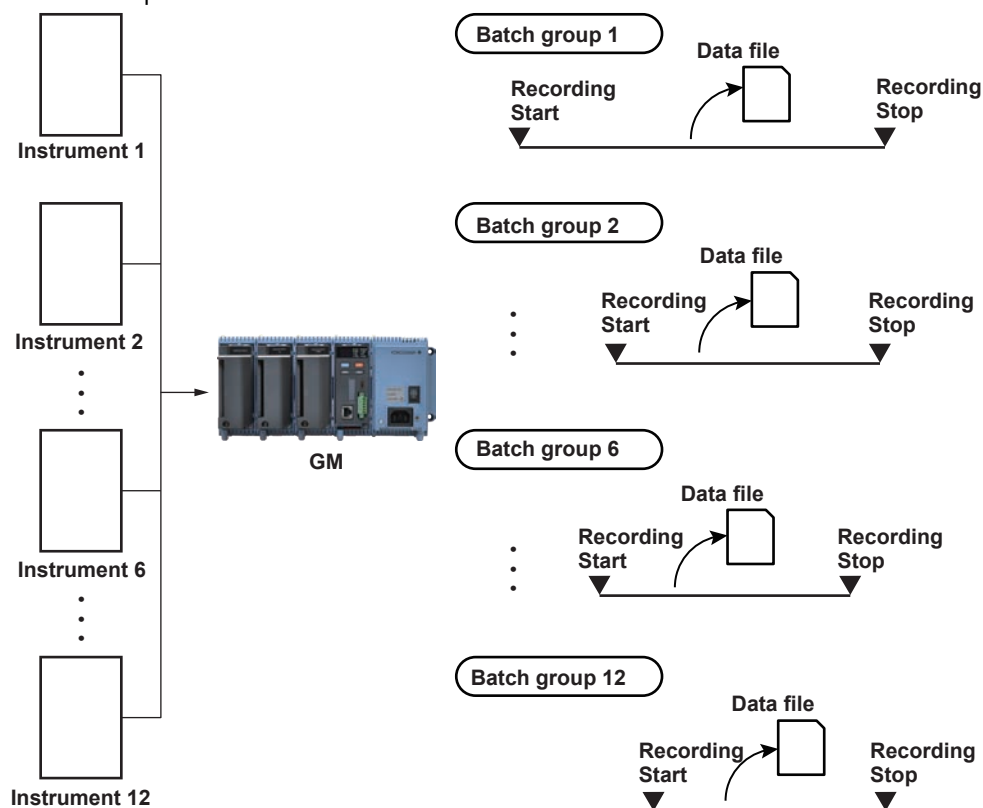

Item	Specifications
Number of multi batches	GM10-1: 6 max., GM10-2: 12 max.
Batch single operation	Memory start/stop, math reset, message writing
Batch overview operation	Computation start/stop, report start/stop, manual sampling, setup data save/load
Scan interval	500 ms, 1 s, 2 s, 5 s (common to all batches)
Data type	Display or event only Trigger mode not available for event data.
Recording interval	Common to all batches
Data file	Display or event data file created for each batch
Number of display groups	GM10-1: Up to 6 per batch (number of channels per group: 20) GM10-2: Up to 12 per batch (number of channels per group: 20)
Batch single settings	Group, trip line, file header, data file name, text field, batch number, lot number

For details, see the Multi-Batch Function (/BT) User's Manual.

1.6.32 Aerospace Heat Treatment (/AH option)

This function supports heat treatment application AMS2750/NADCAP and enables schedule management for periodically executing calibration correction configuration and the like.

- It can be used to manage user-defined schedules for periodical execution.

For details, see page 2-228 in section 2.32, "Using the Aerospace Heat Treatment (/AH option) (Release number 3 and later)".

1.6.33 OPC-UA Server Function (/E3 option)

Data acquired by the GM can be accessed through Ethernet communication from a host system (OPC-UA client).
 Equipped with an OPC-UA server function. GM measurement data can be retrieved directly from a host system, such as SCADA and MES.

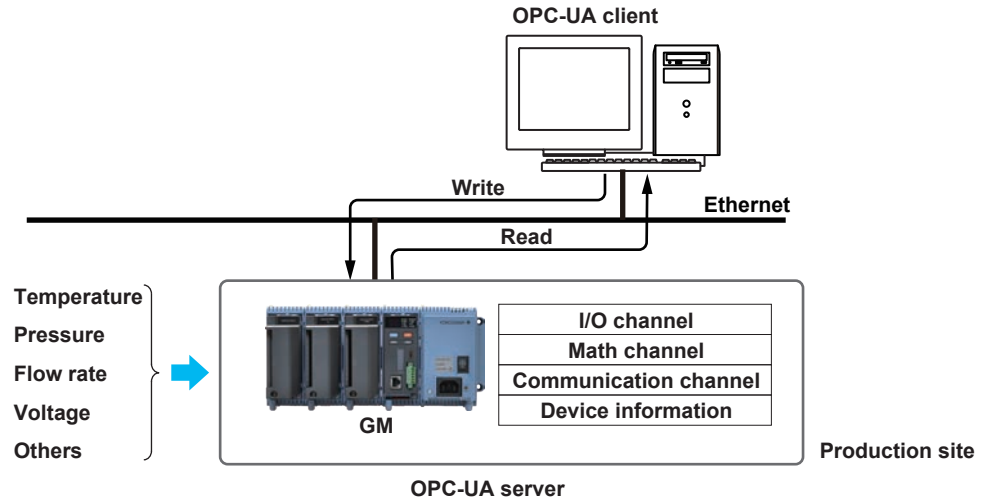

For details, see the OPC-UA Server (/E3) User's Manual.

1.6.34 SLMP Communication (/E4 option)

The SLMP communication (/E4) of the GM is a function for reading and writing data by connecting to an SLMP* server through Ethernet.

- The GM is an SLMP client. The maximum number of connectable servers is 16.

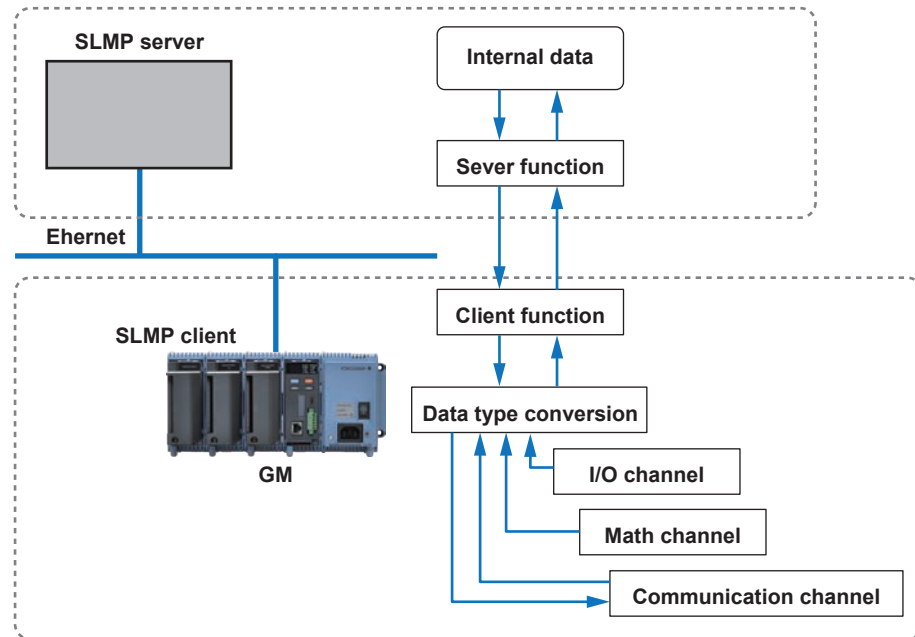

For details, see the SLMP Communication (/E4) User's Manual.

1.6.35 PID Control Function (PID), Program Operation Function (/PG Option)

PID control and program control become possible by installing the PID control module and program control function.

● Control Function

A single PID control module can perform PID control on up to two loops. It is equipped with two control inputs (PV inputs), two control outputs, eight digital inputs, and eight digital outputs. In addition to single loop control, cascade control and loop control with PV switching are possible. For the control output, you can select current output or voltage pulse for each loop.

● Remote Control and Monitoring

Remote monitoring of sites is possible using the Web application. Control loops can be monitored and controlled from a control group screen, and adjustments can be made from a tuning screen.

● Program Control Function (/PG option)

You can perform program control using the program patterns (up to 99 patterns) stored in the GM main unit.

For details, see the Loop Control Function, Program Control Function (/PG Option) User's Manual (IM 04L51B01-31EN).

1.6.36 Equipment/Quality Prediction Function (Release number 5 and later)

Health Monitor Function

By easily creating predictive detection models from past recorded OK/NG data and loading it into GM, you can detect prediction of abnormalities in manufacturing equipment and product quality degradation at an early stage. And because health scores—which show the degree of normal and abnormal data—consider correlations among multiple data to make determinations, they can capture prediction of abnormalities that are difficult for humans to detect.

Profile Function

By creating a profile trend from past recorded data and loading it into GM, this waveform can be used as a threshold for process values. Profile trends are useful in applications where process values change over time. Also, you can see the deviation from the reference waveform on the screen.



- Predictive detection models and profile trends are created with the equipment/quality predictive detection tool (sold separately: cloud or offline).
- You cannot use this when the measurement mode is set to high speed or dual interval.
- If the multi-batch function (/BT option) is enabled, this cannot be used.
- The communication channel function (/MC option) is required for the profile function.
- * The judgment results of equipment/quality predictive detection functions are reference information and do not guarantee performance or accuracy.

1.6.37 PROFINET Communication (Release number 5 (Version 5.02) and later)

By using the network module (GX90NW-02-PN), it can participate in the PROFINET network as an IO device. IO controllers such as PLCs can access the GM's internal data.

- Supports both cyclic communication and acyclic communication.

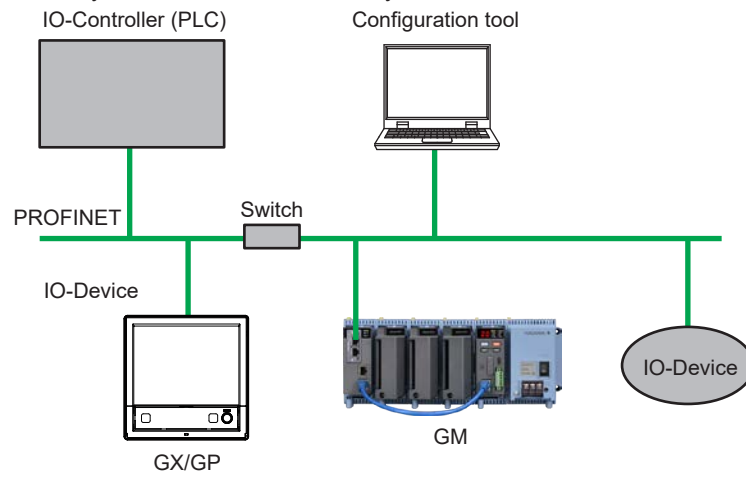

1.7 Names of the GM10 Parts and Functions

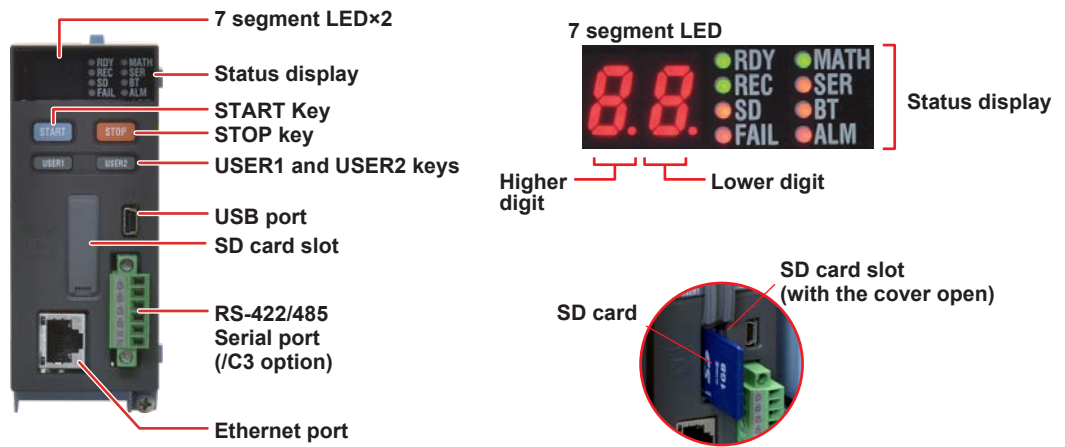

1.7.1 7 segment LED

Displays the GM operation mode, system number, operating status, operation errors, and so on.

Operation mode indication

Operation mode	7 segment LED	Remarks
Normal mode	00	System number display
Fixed IP address mode	00	System number display
A/D calibration mode	88	In A/D calibration mode
Update mode	88	In update mode

System number indication

Displays the instrument tag number. The instrument tag number display shows only the first two characters of the instrument tag number setting. If the first two characters of the instrument tag number setting are not between 0 and 9 or space, they are shown as 0 on the instrument tag number display.

If the instrument tag number is not set or a value other than numerical value is set, nothing is displayed.

Instrument tag number setting	7 segment LED display example
If the character is between 0 and 9 (display example: 88)	88
If the character is not between 0 and 9 or space (display example: Ab, 5C)	00 50
If the characters includes a space (example: space and 2)	2

► For the instrument tag number setting, see page 2-187 in section 2.26.7, “Setting Instrument Tags”.

Operating status

When the GM is turned on, firmware starting indication, operation preparation indication, and self-checking indication are displayed in order.

Firmware starting indication

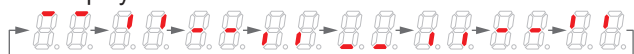

Operation preparation indication



Self-checking indication



Operation error indication

An error code is displayed with an alternating pattern: first the error type and the hundreds digit of the error number and then the lower two digits (the tens and ones digits) of the error number.

Example of how E123 is indicated

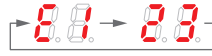

► For details on error codes, see page 5-20 in section 5.2.1, “Messages”.

Key lock indication

	Key lock enabled	Key lock released
Key lock/release indication		
	The lower-digit dot is lit.	The dot is not lit.

Process running indication

If some process is in progress, such as the SD card being accessed or a calibration is in progress, the following indication is repeated. Never remove the SD card when it is being accessed.



Module installation indication

Module installation information is displayed when a module is installed. If a module is removed or malfunctions, an error is indicated.

Module installation indication

Module number
Unit number

Module installation information
P0: When the same modules as those used during system configuration are installed
P1: When different modules than those used during system configuration are installed

Unit confirmation indication

When a GM confirmation operation is performed from a connected IP Address Configurator, the following indication is displayed.



Bluetooth authentication indication

When Bluetooth pairing is executed, a 6-digit authentication code is displayed. The code is repeatedly displayed until pairing is complete (“-” is displayed at the end).



1.7.2 Status Display

The GM operating status is displayed with LEDs.

Status	LED color	Description
RDY	Green	System normal indication
REC	Green	Recording status
SD	Orange	SD card access status
FAIL	Red	System error indication
MATH	Green	Computation (/MT option) status
SER	Orange	RS-422/485 communication (/C3 option) status
BT	Orange	Bluetooth communication (/C8 option) status
ALM	Red	Alarm status

RDY

LED status	Operation description
On	Powered on and normal operating status
Off	Powered off or during shutdown

REC

LED status	Operation description
On	Recording in progress, or trigger-wait state in trigger mode
Off	Recording stopped
Blinking	Transitioning from recording in progress to recording stopped

SD

LED status	Operation description
On	Accessing SD card

FAIL

LED status	Operation description
On	MCU error

MATH

LED status	Operation description
On	Computing
Off	Computing stopped
Blinking	Transitioning from computing to computing stopped

SER

LED status	Operation description
On	RS-422/485 communication connected

BT

LED status	Operation description
On	Bluetooth communication connection standby state
Blinking	Bluetooth communication connected

ALM

LED status	Operation description
On	An alarm is occurring (see below)
Off	No alarms are occurring
Blinking	See below.

The ALM LED states depending on the alarm indication's hold or non-hold setting are illustrated below.

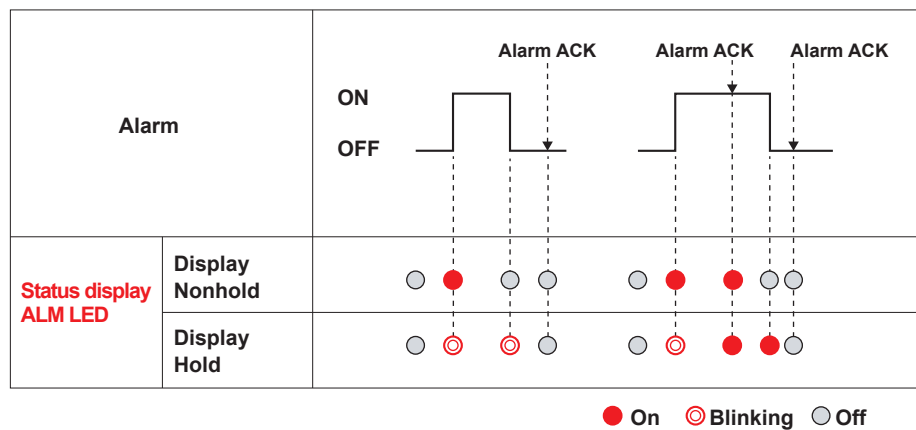

- For details on the alarm indication's hold and non-hold settings, see page 2-182 in section 2.26.3, "Setting the Alarm Display Hold/Nonhold and Individual Alarm ACK Operation".

1.7.3 START, STOP, USER1, and USER2 Keys

START Key

The START key is used to start recording, start reporting,¹ and start computing.¹ This key is valid in normal mode or fixed IP address mode.

¹ When GM10 (/MT option) is in use

Key operation	Recording status	Computation	Computation status	Recording and computing operation
Short press	Stopped	Off	—	No operation
		On	Stopped	Start computing
	Recording	Off	—	No change
		On	Stopped	Start computing
Hold down for at least 3 seconds	Stopped	Off	—	No operation
		On	Stopped	Start recording, start reporting ²
	Recording	Off	—	No change
		On	Stopped	Start recording, start reporting ²
	Recording	Off	—	No change
		On	Stopped	No change
		On	Computing	No change

² When the report function is enabled

Additional operations can be assigned to the START key.

► For details on the settings, see page 2-70 in section 2.9.1, “Setting Basic Computation Operations (Error indications, operation at start, overflow handling, PSUM overflow* handling)”.

Key operation	Operation that can be added	Operation description
Short press	Off	Start computing
Hold down for at least 3 seconds	Start computing ^{1, 3}	Start recording ⁴ and computing simultaneously
	Start computing + reset computation ^{1, 3}	Start recording, ⁴ reset computation, and start computing simultaneously
	Synchronize with SNTP server	Query an SNTP server for the time, synchronize the clock, and then start recording ⁴

³ Only one can be added.

⁴ If the report function is enabled, reporting also starts.

STOP key

The STOP key is used to stop recording, stop reporting,¹ and stop computing.¹ This key is valid in normal mode or fixed IP address mode.

¹ When GM10 (/MT option) is in use

The STOP key operation varies depending on the 7 segment LED display status.

7 segment LED display status		Operation description
System number indication		Stops recording or computation If reporting is in progress, it is also stopped.
Operation error	Error type [F]	No operation
	Error type [E]	Clears the error display

Key operation	Recording status	Computation	Computation status	Recording and computing operation
Short press	Stopped	Off	—	No operation
		On	Stopped	No operation
	Recording	Off	—	No operation
		On	Stopped	No operation
Hold down for at least 3 seconds	Stopped	Off	—	No operation
		On	Stopped	No operation
	Recording	Off	—	Stop Recording
		On	Stopped	Stops recording and reporting ²
			Computing	Stops recording and reporting ²

² When reporting is in progress

Additional operations can be assigned to the STOP key.

- For details on the settings, see page 2-70 in section 2.9.1, “Setting Basic Computation Operations (Error indications, operation at start, overflow handling, PSUM overflow* handling)”.

Key operation	Operation that can be added ³	Operation description
Short press	Off	Stop Computing
Hold down for at least 3 seconds	Stop Computing ¹	Stop recording ³ and computing simultaneously

³ If the report function is enabled, reporting also stops.

USER1 and USER2 Keys

You can assign functions to these keys as you choose. *User function key* refers a key that users can freely assign a function to.

- For details on function assignment, see page 2-135 in section 2.20, “Configuring the Event Action Function”.

1.7.4 Operation Mode

The GM10 has operation modes for performing various operations.

Operation mode	Description
Normal mode	Normal operation mode in which measurement, recording, and so on are performed.
Fixed IP address mode	A mode in which the IP address is fixed (192.168.1.1) and the Web port is fixed (80). Everything else is the same as normal mode. Fixed IP address 192.168.1.1 Subnet mask 255.255.255.0 Web port number 80
A/D calibration mode	A mode for performing A/D calibration. Only A/D calibration can be performed in this mode. Measurement, recording, and so on are not performed.
Update mode	A mode for updating the firmware of input/output modules and expansion modules and updating the Web application. Measurement, recording, and so on are not performed.

Switching to Normal Mode

The GM is in normal mode when it is turned on.

Switching to Fixed IP Address Mode

1. While holding down USER1, turn the power on.
The 7 segment LED displays "C0."
2. Press STOP.
 - To return to normal mode, turn the GM off and then back on (restart).

Switching to A/D Calibration Mode

This is performed from the Web application.

- ▶ For details on A/D calibration, see page 5-5 in section 5.1.3, "Performing A/D Calibration and Adjusting the Input Accuracy of an AI Module".

Switching to Update Mode

This is performed from the Web application.

- ▶ For details on updating, see page 5-17 in section 5.1.8, "Updating the Firmware".

1.7.5 USB Port

A USB2.0 port (mini B type) is available.

Using a dedicated protocol, you can operate and configure the GM10 and output data.

- ▶ For details on setting the USB communication function, see page 2-176 in section 2.24, "Configuring the USB Communication Function".

1.7.6 RS-422/485 Serial Port (/C3 option)

This port is for RS-422/485 serial communication.

- ▶ For details on setting the serial communication function, see page 2-172 in section 2.23, "Configuring the Serial Communication Function (/C3 option)".

1.7.7 Ethernet Port

This port is for Ethernet communication.

- ▶ For details on setting the Ethernet communication function, see page 2-154 in section 2.22, "Configuring the Ethernet Communication Function".

1.7.8 SD Card Slot

SD Card Handling Precautions

- SD cards are delicate and should be handled with caution.
- Yokogawa provides no warranty for damage to, or loss of data recorded on the SD card, regardless of the cause of such damage or loss. Please always make backup copies of your data.
- Do not store or use the SD card in places with static electricity, near electrically charged objects, or where electrical noise is present. Doing so can result in electric shock or damage.
- Do not disassemble or modify the SD card. Doing so can result in damage.
- Do not physically shock, bend, or pinch the SD card. Doing so can lead to malfunction.
- During reading/writing of data, do not turn OFF the power, apply vibration or shock, or pull out the card. Data can become corrupt or permanently lost.
- Only use Yokogawa SD cards. Operation cannot be guaranteed with other brands of card.
- When inserting the SD card into the instrument, make sure you orient the card correctly (face up or down) and that you insert it securely. If not inserted correctly, the card will not be recognized by the instrument.
- Never touch the SD card with wet hands. Doing so can lead to electric shock or malfunction.
- Never use the SD card if it is dusty or dirty. Doing so can lead to electric shock or malfunction.
- The SD card comes formatted. SD cards must be formatted according to the standard established by the SD Association (<https://www.sdcard.org/home>). If using a PC to perform the formatting, use the SD card formatter software available from the above SD Association. The GM does not have a format function.
- You can use SD/SDHC cards (up to 32 GB) on the GM.

Inserting an SD Card

Open the SD card slot cover on the GM10 front panel, and insert an SD card until a click is heard.

Removing the SD Card

Open the SD card slot cover on the GM10 front panel, and push the SD card until a click is heard. Check that the card is disengaged, and remove it from the slot.

Note

Before removing the SD card from the slot, make sure that the SD card is not being accessed.

1.8 Quick Setting Function (Release number 3 (Version 3.02) and later)

In Quick setting, a minimal setup menu for data collection is displayed. Quick setting allows you to collect data quickly.

Display example of the quick settings tree

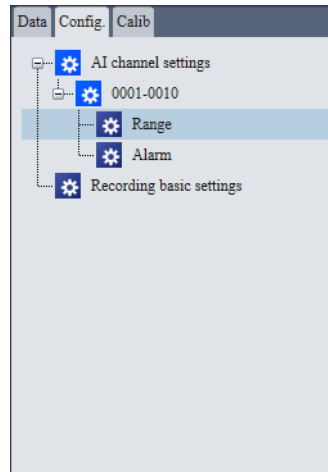

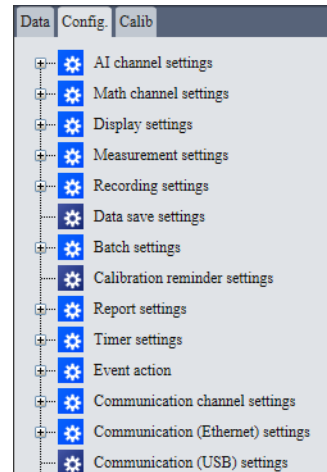

Display example of the standard settings tree



Switching between Standard Setting Tree and Quick Setting Tree

On the SMARTDAC+ Web Service tab, click Quick Setting or Quit Quick Setting to switch between the standard setting tree and quick setting tree.

Button	Function
 Quick setting	The display is switched from the standard setting tree to quick setting tree. When switched to the quick setting tree, the button switches to Quit Quick Setting.
 Quit Quick Setting	The display is switched from the quick setting tree to standard setting tree. When switched to the standard setting tree, the button switches to Quick Setting.

- If the Web application is closed when the quick setting tree is displayed, the next time a connection is established, the quick setting tree will be displayed.

Note

In the following situations, quick settings are invalid (the Switch Quick Setting and Quit Quick Setting buttons are hidden).

- When the advanced security function (/AS option) is On
- If the communication of the security function is set to Login and the user has Setting operation of User property set to Lock

Displaying the Quick Setting Tree

The quick setting tree only displays the range and alarm of I/O channels, recording basic settings, and trend interval.

Display Item	Description
Input/Output channel > Range	Configure settings related to the range of each Input/Output channel.
Input channel > Alarm	Configure settings related to the alarm of each input channel.
Trend interval	Set the trend interval. This does not appear when the file type is set to Event (default value).
Recording basic settings	Set the event data recording interval and the like.
Dual interval settings	Configure settings related to recording for each scan group. * Appears when the measurement mode is Dual interval

- For details on the settings, see chapter 2, “Configuring the GM” on page 2-1. In this manual, the operation path (the order in which displays are opened) is described for Standard setting (tree).

2.1 Preparing to Use the Web Application

This chapter explains how to configure the GM using a browser.
For details how to configure the GM using communication commands, see the *Communication Interface User's Manual* (IM 04L51B01-17EN).

2.1.1 Connecting to a Network

Configuring the GM for Network Connection

To connect the GM to Ethernet, you need to configure the GM in accordance with the network environment.

- ▶ For the configuration procedure, see page 2-154 in section 2.22, "Configuring the Ethernet Communication Function".

Connecting an Ethernet Cable



Do not connect an Ethernet cable whose plug does not comply with FCC specifications.
Doing so may damage the GM.

Connect an Ethernet cable from your network to the Ethernet port on the GM rear panel.

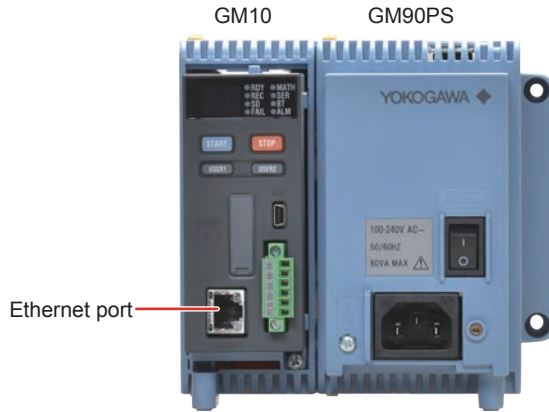

Note

Do not connect an Ethernet cable from the network to the port of the expansion module (GX90EX).
The GX90EX port is used to directly connect between the GX90EX of the main unit to that of a sub unit or between the GX90EXs of two sub units.

2.1.2 Setting the IP Address (IP Address Configurator)

For details on how to install and configure the IP Address Configurator, see the *SMARTDAC+ STANDARD IP Address Configurator User's Manual* (IM 04L61B01-03EN).

Procedure

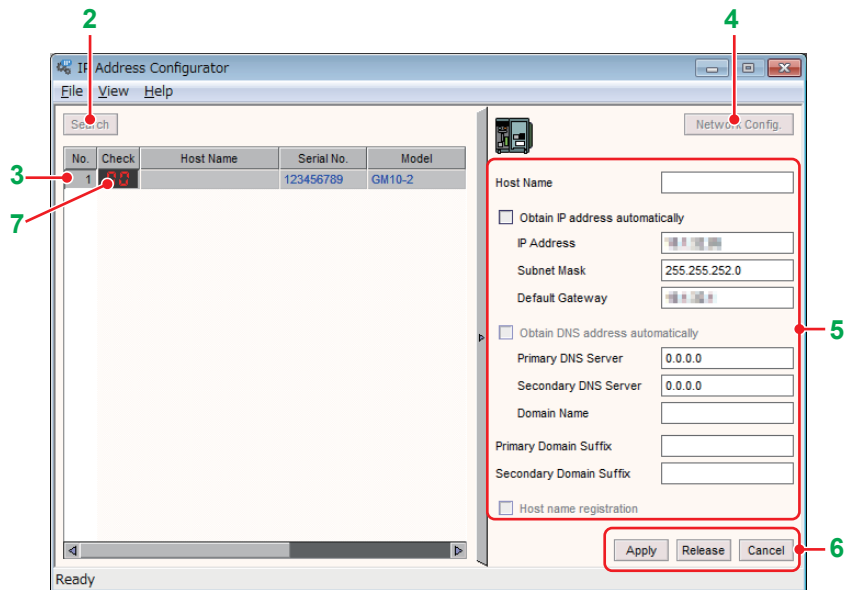

- 1 Start the IP Address Configurator.
The Address Setting screen is displayed.
- 2 Click the **Search** button in the List display screen.
The GMs residing in the same segment are displayed.
- 3 Click the **No.** of the GM whose address you want to change.
The information of the selected GM is shown in blue characters.
- 4 Click **Network Config.** in the Address setting screen.
This enables changes to the settings.
- 5 Enter settings for each item.
- 6 Click **Apply** to change the settings of the GM, **Cancel** to exit without saving changes, or **Release** to clear the IP address from the DHCP server.
- 7 Clicking here will display "--CALL--" on the 7 segment LED of the GM10.



Note

When the GM (firmware version R2.03.01 or later) is in either of the following conditions, the IP address cannot be changed.

- In security settings, Communication is set to Login.
- The advanced security function (/AS option) is set to On, and the GM is recording.

2.1.3 Web Application Overview

You can do the following on the Web application.

- Change settings
- Control the GM
- Monitor data

There is no need to install the Web application. Specify the GM IP address on the Web browser to display the application screen. If a GM is accessed from multiple browsers simultaneously, the Web application performance may degrade.

PC System Requirements

The system requirements are shown below.

Hardware

Item	Specifications
CPU	Windows 10 Intel Core2 Duo E6300 or faster x64 processor
	Windows 11 Intel Core i5 or faster, and 8th generation or later Intel processor.
Internal memory	Windows 10 2 GB or more
	Windows 11 8 GB or more
Hard disk	Windows 10 100 MB or more free space, NTFS recommended
	Windows 11 64 GB or more free space, NTFS recommended
Printer	Printer compatible with the OS
Mouse	Mouse compatible with the OS
Display	A video card compatible with the OS and a display that has a resolution of 1024×768 or higher, and that can show 65,536 colors (16-bit, high color) or more.
Communication ports	Ethernet port compatible with the OS and TCP/IP protocol

OS

Windows 10	Home (32- or 64-bit edition)
	Pro (32- or 64-bit edition)
	Enterprise (32- or 64-bit edition)
	Enterprise LTSC (32- or 64-bit edition)
	Enterprise LTSC (32- or 64-bit edition)
Windows 11	Home (64-bit edition)
	Pro (64-bit edition)
	Enterprise (64-bit edition)

- Yokogawa will also stop supporting OSs that Microsoft Corporation no longer supports.

Web browser

Microsoft Edge or Google Chrome

GM Configuration

You can connect to the Web application when the GM's HTTP server function is on.

- For the procedure, see page 2-168 in section 2.22.9, "Setting the Server Functions to Use (FTP, HTTP, SNMP, MODBUS, GENE, DARWIN compatible communication)".

2.1.4 Starting and Closing the Web Application

Starting the Web Application

If a message appears in the information bar or dialog box when you start or while you are using the Web application, see the note on the next page.

Procedure

- 1 Start the Web browser.
- 2 In the Address box, enter “http://” followed by the GM IP address. If DNS is available, you can specify the host name in place of the IP address.
Example 1: When the IP address is “127.1.1.1,” enter the following in the Address box.
http://127.1.1.1
Example 2: If the HTTP server port has been changed from its default value (80) to “1024,” enter a colon after the IP address and then the port number.
http://127.1.1.1:1024
Example 3: If the HTTP server encryption is set to on
https://127.1.1.1
Example 4: If the HTTP server encryption is set to on and the port is changed from the default value of 443 to 1024
https://127.1.1.1:1024

The Web application starts, and the screen appears.

If the login function is enabled, a user authentication dialog box appears. Proceed to step 3.

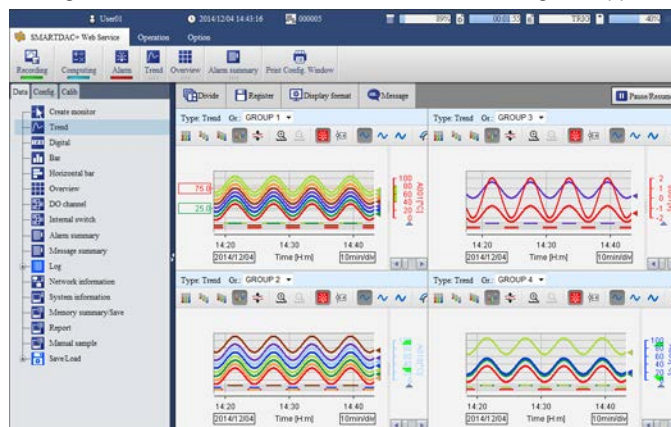

- 3 Enter the correct user name and password, and click **OK**.
The Web application starts, and the screen appears.

Start Screen

The Web application starts with the default display conditions or the display conditions that were in use when the application was closed the previous time (see “Closing the Web Application”).

Note

- If the GM login function is changed while the Web application is in use, you may need to reload the page or restart the browser. Follow the instructions in the message.
- During operation, a message generated by the Web application or the GM may appear. For details on these messages, see page 5-20 in section 5.2.1, "Messages".

**Closing the Web Application**

When close the browser, the Web application also closes.

Display Condition Storage and the Application of the Display Conditions the Next Time the Application Starts

When the Web application closes, the display conditions are saved to the GM. If the login function is enabled, the display conditions that are in use when the Web application is closed are saved for each user.

The next time the Web application starts, it will apply the display conditions saved in the GM. If the GM configuration has been changed and it conflicts with the saved display conditions, the default display conditions will be used.

Screen

The screen configuration is shown below.

Note

Set the browser's zoom (on the **View** menu, click **Zoom**) to 100%. Otherwise, the layout may appear crooked.

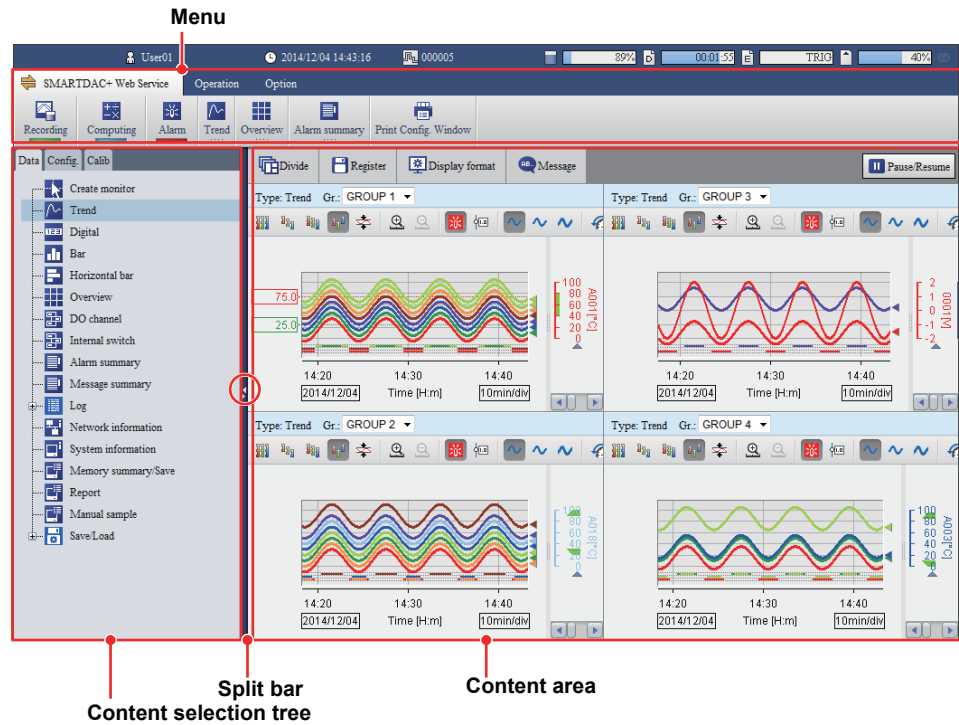

Name	Description
Menu bar	Consists of three tabs: SMARTDAC+ Web Service , Operation , and Option . You can show or hide the menu (button) area by double-clicking the tab.
Content selection tree	Used to select the contents to display in the content area. There are three tabs: Data , Config , and Calib . The Control settings tab is displayed when a PID control module is recognized.
Content area	Area for displaying content.
Split bar	Drag the split bar to change the panel width of the content selection tree and content area. While you drag the split bar, the content area displays an alternate screen (see the note below). Click the show/hide button (indicated with a red circle) to show or hide the content selection tree.

Status Indications

The menu bar shows the GM status.

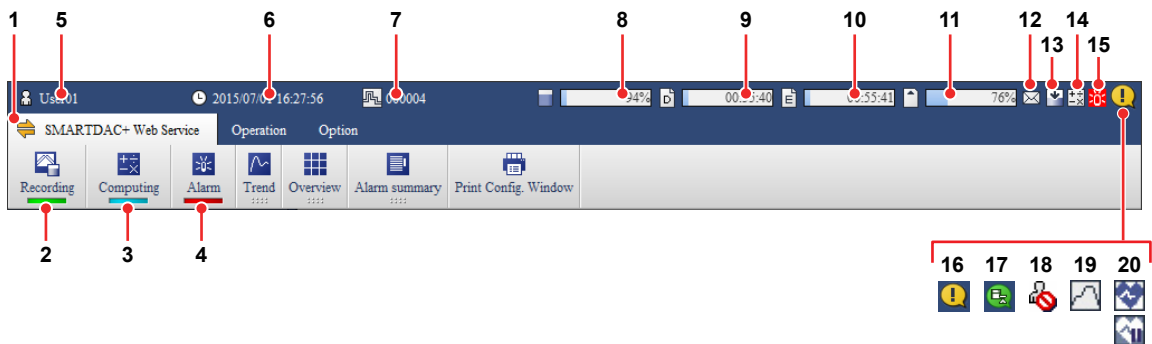

Number	Description
1	Communication status. Turns on in yellow when communication with the GM is normal. If you move the mouse pointer over the icon and hold it there for about 1 second, "Normal" or "Error" will appear in a pop-up window. If communication with the GM is disconnected or recovers, a bubble message indicating the condition will appear for a few seconds.

2	Recording status. Turns on in green when recording.										
3	Indicates the computation status of computation channels.										
	<table border="1"> <thead> <tr> <th>Status</th> <th>Description</th> </tr> </thead> <tbody> <tr> <td>Off</td> <td>Computation stopped.</td> </tr> <tr> <td>Blinking yellow</td> <td>Computation stopped with error.</td> </tr> <tr> <td>Blue</td> <td>Computing.</td> </tr> <tr> <td>Alternating blue and yellow</td> <td>Computing with error.</td> </tr> </tbody> </table>	Status	Description	Off	Computation stopped.	Blinking yellow	Computation stopped with error.	Blue	Computing.	Alternating blue and yellow	Computing with error.
Status	Description										
Off	Computation stopped.										
Blinking yellow	Computation stopped with error.										
Blue	Computing.										
Alternating blue and yellow	Computing with error.										

4	Alarm status.										
	<table border="1"> <thead> <tr> <th>Status</th> <th>Description</th> </tr> </thead> <tbody> <tr> <td>Off</td> <td>No alarms. All alarms acknowledged.</td> </tr> <tr> <td>Red</td> <td>Alarms present. All alarms acknowledged.</td> </tr> <tr> <td>Blinking green</td> <td>No alarms. Unacknowledged alarms present.</td> </tr> <tr> <td>Blinking red</td> <td>Alarms present. Unacknowledged alarms present.</td> </tr> </tbody> </table>	Status	Description	Off	No alarms. All alarms acknowledged.	Red	Alarms present. All alarms acknowledged.	Blinking green	No alarms. Unacknowledged alarms present.	Blinking red	Alarms present. Unacknowledged alarms present.
Status	Description										
Off	No alarms. All alarms acknowledged.										
Red	Alarms present. All alarms acknowledged.										
Blinking green	No alarms. Unacknowledged alarms present.										
Blinking red	Alarms present. Unacknowledged alarms present.										

5	Login user name.
6	GM date and time.

7	Batch name. Displayed when the batch function is in use. If the information does not fit in the area, the information will scroll at certain intervals.
---	---

8	Internal memory information.











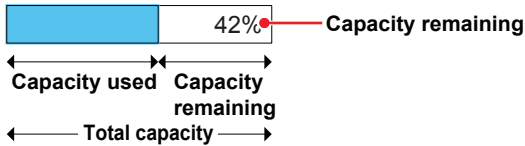





9	Recording progress status.
---	----------------------------

Icon	Description
D	Display data file
E	Event data file (when the measurement mode is set to Normal or High speed)
E1, E2	Event data file of measurement groups 1 and 2 (when the measurement mode is set to Dual interval)

--	--

If pre-trigger is specified for event data recording, the GM will start recording pre-trigger data when recording is started and the GM enters the trigger-wait state. "TRIG" appears in the bar graph.

2.1 Preparing to Use the Web Application

Number	Description
11	<p>SD card capacity information.</p>  <p>The diagram shows a horizontal bar representing total capacity. A portion on the left is shaded blue and labeled 'Capacity used'. The remaining portion on the right is white and labeled 'Capacity remaining' with '42%' written inside. A red arrow points from the text 'Capacity remaining' to the white portion of the bar. Below the bar, three double-headed arrows indicate the extent of 'Capacity used', 'Capacity remaining', and 'Total capacity'.</p>
12	 Mail transmission function. Displayed when the mail transmission function is in use.
13	 This icon appears when recording is started. It disappears when recording is stopped.
14	 This icon appears when computation is started. It disappears when computation is stopped.
	 When a yellow icon is blinking: Computation data dropout occurred.
15	<p>This icon appears when any alarm is occurring.</p> 
	 ↔  It blinks if some alarms have not been acknowledged.
	 ↔  It blinks when all alarms have been cleared, but some alarms have not been acknowledged.
16	 Error information. Displayed when an error occurs. Click the icon to clear it.
17	 Data save information. Appears when the internal memory data is being saved to the external storage medium. Clicking the icon displays a data save cancel dialog box.
18	 User lock out occurring. Appears when there is a locked out user.
19	 Program running (/PG option)
20	 Predictive detection is running
	 Loading of profile trend is paused

2.1.5 Setup Guide

This section describes the GM setup procedure.

GM Setup Procedure

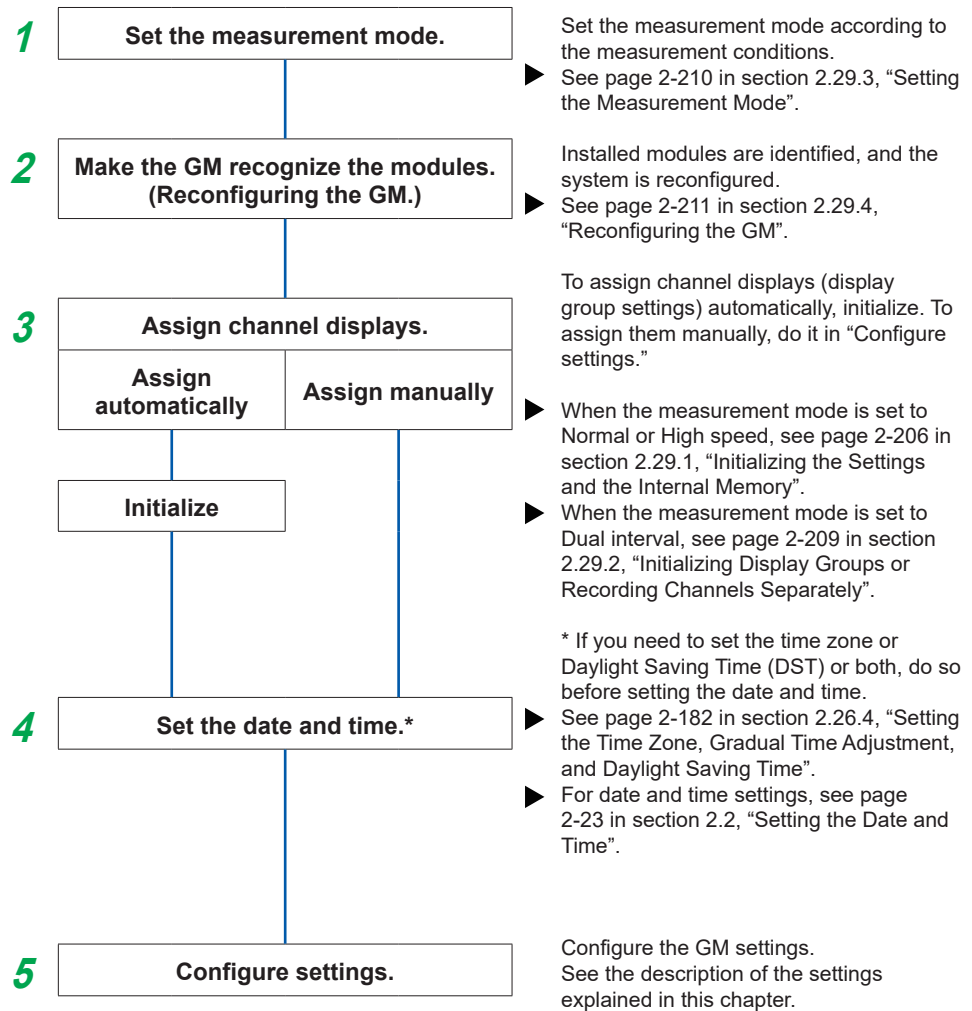

2.1.6 Change settings

Follow the procedure below to change the GM settings.

Note

The items and selectable values that appear in the setup screen vary depending on the hardware system configuration. If the items that you want to configure do not appear, check the option and module configuration on the system information monitor.

Notes on Changing Settings

When Settings Can Be Changed

- If you are logged in using an account that prohibits setting changes, you will not be able to change the settings.

Limitations on Modifying Settings

- When not using the login function
There are no limitations on modifying settings.
- When using the login function
If you are connected to the GM with an Admin account, there are no limitations on modifying settings.
If you are connected to the GM with a User account, you cannot specify the security settings (Security settings will not appear in the Config tab).

Limitations on Changing the Login Password

If you click the Config tab > Security settings > User settings, you will not be able to set the user login password. You can only initialize the password. The default password is “default.” To change the user password, log in using the user’s account, click Password change on the Option tab, and change it.

Applying Setting Changes

On each setup screen, send the changed settings to the GM to apply them.

Note

When settings are changed, the message “Restart is required to reflect this changes. Continue?” may appear. Click OK, and the GM will automatically restart.

Setup Change Procedure

- 1 Click the **Config.** tab.
The setup item tree appears.
- 2 Click the item you want to change.
The GM settings are loaded and displayed in the content area.
Click **Reload** to load and update the displayed settings.

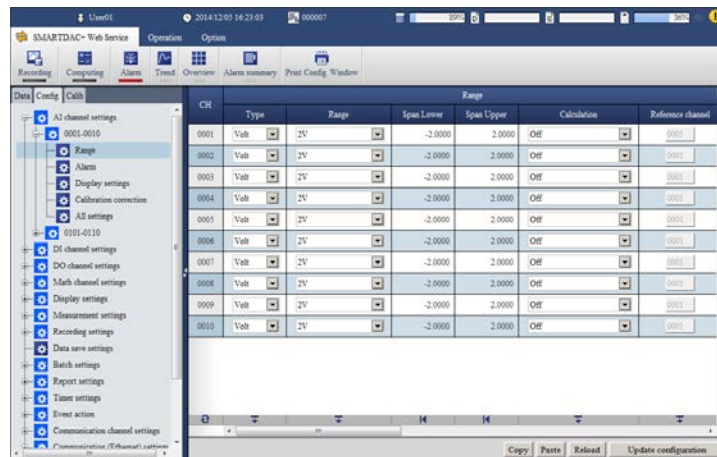

- 3 Edit the settings.
For the procedure to set each item, see the reference table below.

Setup Item	Refer To
AI channel	sec. 2.3
DI channel	sec. 2.4
Pulse input channel	sec. 2.5
AO channel	sec. 2.6
DO channel	sec. 2.7
PID control channel (Only the items are listed with references to the manual (document name and number).)	sec. 2.8
Math channel	sec. 2.9
Logic math	sec. 2.10
Equipment/quality prediction settings	sec. 2.33
Display settings	sec. 2.11
Measurement settings	sec. 2.12
Recording settings	sec. 2.13
Dual interval settings	sec. 2.14
Data save settings	sec. 2.15
Batch settings	sec. 2.16
Report settings	sec. 2.17
Timer settings	sec. 2.19
Event action	sec. 2.20
Communication channel settings	sec. 2.21
Communication (Ethernet) settings	sec. 2.22
Communication (serial) settings	sec. 2.23
Communication (USB) settings	sec. 2.24
Communication (Bluetooth) settings	sec. 2.25
Network module settings (Only the items are listed with references to the manual (document name and number).)	
System settings	sec. 2.26
Security settings	sec. 2.27

- 4 Click **Update configuration**.
The GM settings are changed.

Note

- If you edit the settings and switch to a different setting screen before applying the settings, the edited settings will be discarded.
- If you edit the settings and click **Reload** before applying the settings, the edited settings will be discarded.

Editing Settings

This section gives examples of setup editing operations.

Input Controls and Dialog Boxes

The following table shows the input controls and dialog boxes that are used to edit settings on the Web application.

Control Type	Display Example	Operation Example	Setup Procedure
Text box	-2.0000	Operation example 1	Enter text and numbers.
Check box	<input checked="" type="checkbox"/>	Operation example 2	Click to select the check box. A selected check box indicate "On" or "enabled."
List		Operation example 1	Click the arrow and select from the list that appears.
Option button	<input checked="" type="radio"/> Point <input type="radio"/> Comma	–	Click to select.

Dialog Box Type	Operation Example	Setup Procedure
Channel selection	Operation example 1	When configuring a specific channel, such as an I/O channel, click a channel number button to specify the channel.
Color selection	Operation example 2	From the color selection palette in the dialog box, click a color. You can also enter RGB values to specify a color freely.
Multiple channel selection	Operation example 3	When specifying multiple channels, such as when configuring a display group, click channel number buttons to add channels as character strings to the channel configuration area of the dialog box.
Element selection	Operation example 4	When specifying an internal switch or other item, click the displayed switch number string. (This is similar to channel selection.)
Calibration correction	Operation example 5	Edit calibration correction values. Enter the values directly.
Calculation expression input	Operation example 6	A dialog box for entering calculation expressions. Set calculation expressions by selecting operators and channels from the lists that appear.

In the following pages, representative operation examples in which the dialog boxes above appear will be given.

Examples of Other Editing Operations

See also the following examples of editing operations.

- Operation example 7** Selecting a range
- Operation example 8** Copying and pasting
- Operation example 9** Range selection and copying and pasting in table type screens
- Operation example 10** Editing table type screens using tool buttons
- Operation example 11** Selecting and unselecting check boxes at once
- Operation example 12** Copying and pasting check boxes at once
- Operation example 13** Jumping to a specific item in table type screens

Operation Example 1

The DI channel settings screen is shown below.

CH	Type	Range			Calculation	Reference channel	Decimal
		Span Lower	Span Upper				
0201	DI	0	1		Off	0001	2
0202	Skip	0	1		Off	0001	2
0203	Pulse	0	1		Off	0001	2
0204	DI	0	1		Off	0001	2

Click here (▼) to show the available values.

Click to display the channel selection dialog box (figure below).

Click to enter the span values.

Channel selection dialog box

The dialog box displays three sections: AI channel (0001-0010), DI channel (0501-0610), and DO channel (0701-0906). Each section has a grid of channel numbers. At the bottom, there are checkboxes for 'AI channel', 'DI channel', and 'DO channel'. A 'Cancel' button is at the bottom center.

The channel that you click is reflected in the setup screen, and the dialog box closes.

Show or hide by channel type (when multiple channel types are available).

To not change or set click Cancel to return.

Operation Example 2

The DI channel settings screen is shown below.

CH	Star graph base position	Indicator	Scale	Mark kind	Alarm point mark				Display of
					Alarm 1 color	Alarm 2 color	Alarm 3 color	Alarm 4 color	
0501	Lower	<input checked="" type="checkbox"/>	1	Fixed	Red	Orange	Orange	Red	Start
0502	Lower	<input type="checkbox"/>	1	Alarm	Red	Orange	Orange	Red	Start
0503	Lower	<input type="checkbox"/>	1	Fixed	Red	Orange	Orange	Red	Start

Click to select the check box.

Click to enter a character string.

Click to open the display color dialog box (figure below).

Display color dialog box

To create a color, click the text boxes and enter values.

The dialog box shows 'Current color Red' with RGB values (R: 255, G: 0, B: 0). Below is a 'Key color' palette with various color swatches. At the bottom are 'OK' and 'Cancel' buttons.

Click a color to select it.

Operation Example 3

This example shows how to assign channels to group 1 on the screen that appears when you click **Display settings** and then **Group settings**.

Group number	On/Off	Group name	Channel set
1	<input checked="" type="checkbox"/>	GROUP 1	A001.A002.A003.04.A006.A007.A008

Select the check box.

Click to open the group settings dialog box (figure below).

Group settings dialog box

Group configuration channels

You can easily change the display order of channels.

Select a channel, and drag the channel to the appropriate position.

Select the channel check boxes to add the channels to the group.

Selected channels

Show or hide by channel type.

Click OK to apply the settings to the configuration screen.

Note

If the maximum number of selectable channels is reached, you will no longer be able to select additional channels.

Operation Example 4

This example shows how to set the alarm output destination on the DI channel settings screen.

CH	On/Off	Type	Value	Hysteresis	Logging	Output type	Output No.
0501	<input checked="" type="checkbox"/>	H: High limit	0.00	0	<input checked="" type="checkbox"/>	Internal switch	1
0502	<input type="checkbox"/>	H: High limit	0.00	0	<input checked="" type="checkbox"/>	Out	
0503	<input type="checkbox"/>	H: High limit	0.00	0	<input checked="" type="checkbox"/>	Out	

Select the check box.

Click to open the Alarm level 1 Output No. dialog box (figure below).

Alarm level 1 Output No. dialog box

The internal switch number that you click is reflected in the setup screen and the dialog box closes.

To not change or set, click Cancel to return.

Operation Example 5

This example shows how to edit calibration correction on the AI channel settings screen. Select the calibration correction mode. Select the number of set points.

CH	Mode	Number of set points	Linearizer input/output
0001	Linearizer Approximation	12	Linearizer input/output
0002	Off		Linearizer input/output

Click to open the calibration correction dialog box (figure below).

Calibration correction dialog box

Calibration correction points

Linearizer input/output number	Linearizer input	Linearizer output	Execution of the input measurement
1	-2.0000	-2.0000	Execute
2	-1.6364	-1.6364	Execute
3	-1.2727	-1.2727	Execute
4	-0.9091	-0.9091	Execute
5	-0.5455	-0.5455	Execute
6	-0.1818	-0.1818	Execute
7	0.1818	0.1818	Execute
8	0.5455	0.5455	Execute
9	0.9091	0.9091	Execute
10	1.2727	1.2727	Execute
11	1.6364	1.6364	Execute
12	2.0000	2.0000	Execute

Edit set points.

Click OK to save the edited results.

For the procedure to set calibration correction, see page 2-43 in section 2.3.4, "Setting Calibration Correction (Linearizer approximation, linearizer bias, Correction factor* (release number 3 and later))".

Operation Example 6

This is an example of entering a calculation expression in a calculation expression input dialog box in the Calculation expression setup screen of Math channel settings.

CH	On/Off	Calculation expression
A001	<input checked="" type="checkbox"/>	0001
A002	<input checked="" type="checkbox"/>	0001
A003	<input checked="" type="checkbox"/>	0001
A004	<input type="checkbox"/>	0001

Select an On/Off check box and click Calculation expression to open a dialog box for entering an expression.

Math channel [A001] Calculation expression

0001

Basic operator

Basic operator | Relation operator | Logical operator | Statistic operator | Special operator | Cond

SQR() | ABS() | LOG() | EXP() | LN()

()

OK

Cancel

Calculation expression edit box

Select the operator type from the list box or tabs to display operator buttons.

Click the button for the operator you want to insert in the calculation expression. The operator appears in the calculation expression edit box.

Click OK to close the dialog box. The entered expression appears in Calculation expression in the setup window.

2.1 Preparing to Use the Web Application

Moving the cursor over the Calculation expression column on the setup screen shows the entire expression in a pop-up. This is useful when you want to view a long expression that does not fit in the column.

CH	On/Off	Calculation expression	Decimal place
A001	<input checked="" type="checkbox"/>	0101+0102+0103+0104+0105+0106+0107+0108+0109+0110+0111+0112+0113+(2
A002	<input checked="" type="checkbox"/>	0001	2
A003	<input checked="" type="checkbox"/>	0001	2

When you click Update Config to send the settings to the GM, if the calculation expression appears in red, the expression is invalid. Refer to the pop-up that appears showing an error message.

Range Selection and Copying and Pasting

You can select a range of settings and edit them collectively or copy and paste them. This section explains how to select a range of settings and how to use the Copy, Paste, and Tool buttons.

Operation Example 7

Selecting a range

The screen that appears when you select **Display settings** and then **Trend settings** will be used as an example to explain the procedure.

- 1 Click a line name.

Trend settings	
Direction	<input checked="" type="radio"/> Vertical <input type="radio"/> Horizontal
Trend clear	<input type="radio"/> Off <input checked="" type="radio"/> On
Trend line	<input type="radio"/> Thick <input checked="" type="radio"/> Normal <input type="radio"/> Thin
Grid	Auto
Scale	
Digit	<input checked="" type="radio"/> Normal <input type="radio"/> Fine
Value indicator	<input checked="" type="radio"/> Mark <input type="radio"/> Bar graph
Digit of mark	3 digits
Partial	
On/Off	<input checked="" type="radio"/> Off <input type="radio"/> On
Message	
Write group	<input checked="" type="radio"/> Common <input type="radio"/> Separate
Power-fail message	<input checked="" type="radio"/> Off <input type="radio"/> On
Change message	<input checked="" type="radio"/> Off <input type="radio"/> On

Click the line name.

The line is selected.

- 2 Drag the cursor and release the mouse at the last line you want to select.

Trend settings	
Direction	<input checked="" type="radio"/> Vertical <input type="radio"/> Horizontal
Trend clear	<input checked="" type="radio"/> Off <input type="radio"/> On
Trend line	<input type="radio"/> Thick <input checked="" type="radio"/> Normal <input type="radio"/> Thin
Grid	Auto
Scale	
Digit	<input checked="" type="radio"/> Normal <input type="radio"/> Fine
Value indicator	<input checked="" type="radio"/> Mark <input type="radio"/> Bar graph
Digit of mark	3 digits
Partial	
On/Off	<input checked="" type="radio"/> Off <input type="radio"/> On
Message	
Write group	<input checked="" type="radio"/> Common <input type="radio"/> Separate
Power-fail message	<input checked="" type="radio"/> Off <input type="radio"/> On
Change message	<input checked="" type="radio"/> Off <input type="radio"/> On

Drag across line titles to select multiple lines.

Multiple lines are selected.

Note

When selecting a range, you cannot select multiple nonconsecutive lines one by one. You cannot select an individual column.

Operation Example 8

Copying and Pasting

You can edit copied information in Excel or text editor and paste it back in the Web application. Below is an example of how to edit information in Excel.

- 1 Select the copy source.
- 2 Click **Copy**, which is in the lower right of the screen. You can also press Ctrl+C on the keyboard.
- When the range is copied to the Clipboard, the color of the range changes as shown below.

Trend settings	
Direction	<input checked="" type="radio"/> Vertical <input type="radio"/> Horizontal
Trend clear	<input checked="" type="radio"/> Off <input type="radio"/> On
Trend line	<input type="radio"/> Thick <input checked="" type="radio"/> Normal <input type="radio"/> Thin
Grid	Auto

- 3 Paste the contents of the Clipboard to an Excel spreadsheet. The figure below shows an example in which the contents are copied to cell A1 of an Excel spreadsheet.
- If the pasted contents do not appear correctly, check the format of the cell that you are pasting to.

	A	B	C
1	Trend clear	Off	
2	Trend line	Normal	
3	Grid	Auto	
4			

- 4 Edit the settings in Excel.

	A	B	C
1	Trend clear	Off	
2	Trend line	Normal	
3	Grid	Auto	
4			

➔

	A	B	C
1	Trend clear	On	
2	Trend line	Thin	
3	Grid	5	
4			

Edit the values in the B column in Excel.

- 5 Copy the edit results from the Excel spreadsheet. Copy not just the values but also the item names in row A.

	A	B	C
1	Trend clear	On	
2	Trend line	Thin	
3	Grid	5	
4			

- 6 Select the paste destination. Make the paste range the same as the range of the copied data (the number of lines).

Trend settings	
Direction	<input checked="" type="radio"/> Vertical <input type="radio"/> Horizontal
Trend clear	<input checked="" type="radio"/> Off <input type="radio"/> On
Trend line	<input type="radio"/> Thick <input checked="" type="radio"/> Normal <input type="radio"/> Thin
Grid	Auto

- 7 Click **Paste**, which is located in the lower right of the window. You can also press Ctrl+V on the keyboard.

Trend settings	
Direction	<input type="radio"/> Vertical <input checked="" type="radio"/> Horizontal
Trend clear	<input type="radio"/> Off <input checked="" type="radio"/> On
Trend line	<input type="radio"/> Thick <input type="radio"/> Normal <input checked="" type="radio"/> Thin
Grid	5

The edit results from the Excel spreadsheet is pasted to the configuration window.

Note

- Depending on the format of the Excel cells that you are pasting to, the values may change when you paste the contents from the Clipboard. For example, if the format is set to **Number**, "0001" will change to "1". You can prevent pasted values from being automatically corrected by setting **Number to Text** in the Format Cells dialog box of the Excel sheet that you want to paste to.
- If the values cannot be pasted as they are to the Excel sheet even with the settings above, we recommend that you use a text editor for copying and pasting.
- If the values that you edit with Excel or text editor are outside the setting range, when you paste the data, the values will be corrected in the same way as when you enter values directly.

Operation Example 9

Range Selection and Copying and Pasting in Table Type Screens

The AI channel settings screen will be used as an example to explain the procedure. In table type screens, you can also edit copied information in Excel or text editor and paste it back in the Web application (see note on page 2-18).

- 1 Select a range of channels as shown below.

CH	Type	Range	Range		Calculation	Reference channel	Decimal place
			Span Lower	Span Upper			
0001	Skip	V	-2.0000	2.0000	Off	0001	0
0002	Volt	200mV	-100.00	150.00	Off	0001	0
0003	TC	S	10.0	25.0	Delta	0001	0
0004	RTD	Pt100	-200.0	850.0	Linear scaling	0001	2

Click the name of the line to select the entire line. Drag down to select multiple lines.

- 2 Copy the channel information (lines).

CH	Type	Range	Range		Calculation	Reference channel	Decimal place
			Span Lower	Span Upper			
0001	Skip	V	-2.0000	2.0000	Off	0001	0
0002	Volt	200mV	-100.00	150.00	Off	0001	0
0003	TC	S	10.0	25.0	Delta	0001	0
0004	RTD	Pt100	-200.0	850.0	Linear scaling	0001	2

Press Ctrl+C, or click Copy to copy the cells.

3 Paste to different channels.

CH	Range		Range		Calculation	Reference channel	Decimal place
	Type	Range	Span Lower	Span Upper			
0001	Skip	2V	-2.0000	2.0000	Off	0001	2
0002	Volt	200mV	-100.00	150.00	Off	0001	2
0003	TC	S	10.0	25.0	Delta	0001	2
0004	RTD	Pt100	-200.0	850.0	Linear scaling	0001	2
0005	Skip	1.5V	0.3000	2.0000	Square root	0001	2
0006	Volt	200mV	-100.00	150.00	Off	0001	2
0007	TC	S	10.0	25.0	Delta	0001	2
0008	RTD	Pt100	-200.0	850.0	Linear scaling	0001	2
0009	Volt	2V	-2.0000	2.0000	Off	0001	2
0010	Volt	2V	-2.0000	2.0000	Off	0001	2

Select the cells to paste to.
Press Ctrl+V to paste to the cells.

Note

You cannot use the Paste button. To paste, press Ctrl + V on the keyboard, or select Paste from the browser's menu.

Operation Example 10

Editing Table Type Screens Using Tool Buttons

On table type windows, you can use the tool buttons that are shown at the bottom of each table. The available types of tool buttons are "Initialize", "Paste to all lines", "Increment", "Minimum", "Maximum", and "Change all". You can use them to edit items collectively. In the example below, the **Paste to all** tool button is used to set the **Type** of all selected channels in the AI channel setting screen.

- 1 Select the line that contains the data you want to copy.
CH0001 is selected.

Select the line to copy from.

Data to copy

Paste destination

- 2 Drag the cursor to the last line that you want to assign the same type.
Channels up to CH0004 are selected.

CH	Range		Range		Calculation
	Type	Range	Span Lower	Span Upper	
0001	Volt	2V	-2.0000	2.0000	Off
0002	GS	1-5V	1.0000	5.0000	Linear scaling
0003	GS	1-5V	1.0000	5.0000	Linear scaling
0004	GS	1-5V	1.0000	5.0000	Linear scaling
0005	Volt	2V	-2.0000	2.0000	Off
0006	Volt	2V	-2.0000	2.0000	Off

Drag until the last line you want to paste the same data to.

3 Click **Paste to all** on the tool bar.

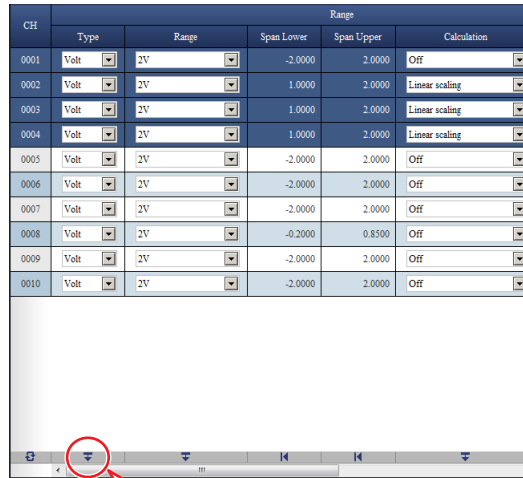

Click the “Paste to all” tool button.

The type of CH0002 to CH0004 is set to **Volt**.

Note

- When you use the tool button to paste settings to change the settings, the values are automatically corrected in the same way as when you enter values directly.
- Tool buttons are unavailable when no cells are selected (except for the “Change all” button).

The table below shows the different tool button types and their functions.

Button	Icon	Function
Paste to all		Pastes the value in the first selected line to all other lines.
Increment		<ul style="list-style-type: none"> • For numeric input Paste numbers to all selected lines by auto-incrementing the least significant digit, starting with the number in the first selected line. • For character string input Paste the character string of the first line appended with auto-incremented sequence numbers to all selected lines. If the character string of the first selected line ends with a number, this number will be used as the first sequence number. If the character string of the first selected line ends with a character, the sequence number 1 is appended to the character string of the first selected line.
Initialize		Initializes the values of the selected lines to their defaults.
Minimize		Sets the values of the selected lines to their minimum values.
Maximize		Sets the values of the selected lines to their maximum values.
Change all		<ul style="list-style-type: none"> • For check boxes Switches the check box values of the selected lines at once. If all the check boxes of the selected lines are selected, they are cleared. If they are cleared, they are selected. • For line name (left most) columns Selects or unselects all lines in the table.

Operation Example 11**Selecting and Unselecting Check Boxes at Once**

The example below shows the screen that appears when you select **Display settings - Group settings - Channel set**.

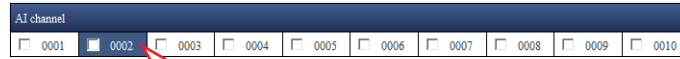
Selecting a Range of Check Boxes

Click a label in a cell to select a single cell.

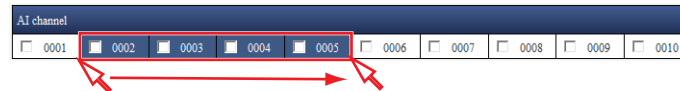

Drag to select cells in a rectangular area.

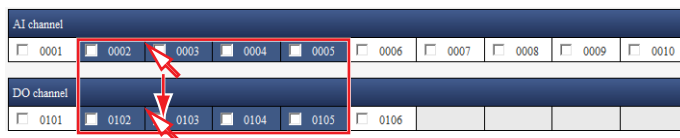

Selection can be made across different blocks.

Selecting or Unselecting at Once

Follow the procedure below to select or unselect check boxes at once.

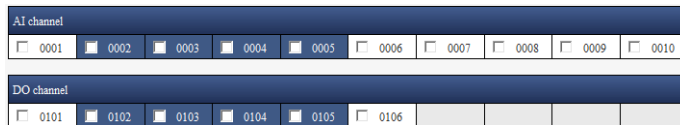

Click **On/Off**, or hold down **Ctrl** and click a check box to select or unselect all the check boxes in the selected area at once.

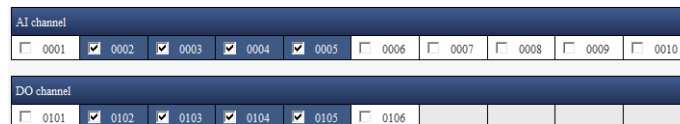

All the check boxes in the selected range are selected.

Each time you click **On/Off**, the check boxes in the selected range become selected or unselected at once.

Hold down **Ctrl** and click a check box that is selected to unselect all check boxes in the selected range. Hold down **Ctrl** and click a check box that is not selected to select all check boxes in the selected range.

Operation Example 12

Copying and Pasting Check Boxes at Once

Follow the procedure below to paste the copy source. In check box type screens, you can also edit copied information in Excel or text editor and paste it back in the Web application. In Excel, a selected check box is indicated as On; an unselected check box is indicated as Off.

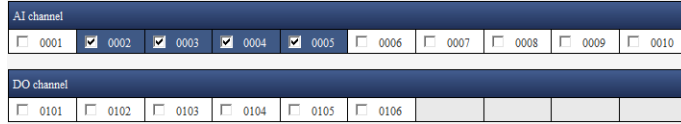

Select the cells to copy from, and press Ctrl+C to copy.

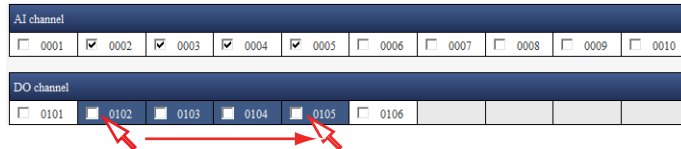

Select the cell to paste to and drag to select a range.

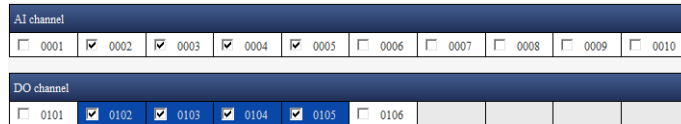

Press Ctrl+V to paste.

Note

If the cells whose check box is selected (on) reaches the maximum selectable number, cells whose check boxes are unselected become unavailable, and you will not be able to paste to them. You cannot paste to cells that do not have check boxes.

Operation Example 13

Jumping to a Specific Item in Table Type Screens

In a table type setup screen (e.g., AI channel settings), not all the setup items fit on the screen. In such a case, you can jump to a specific item you want to set.

- 1 Click the icon in the upper right of the screen. A list box for selecting the jump destination appears.
- 2 Enter the target channel, and click the item that you want to set. The specified setup item is displayed.

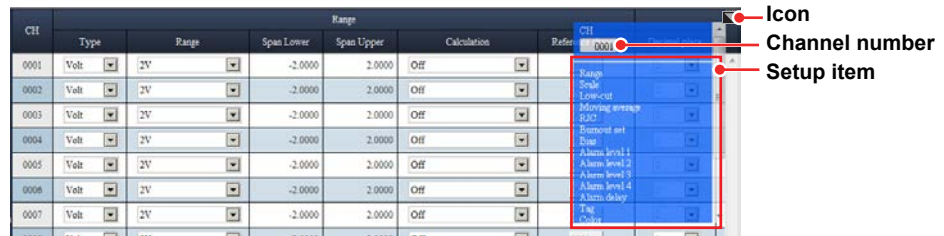

Click the icon to clear the list box.

2.2 Setting the Date and Time

Set the date and time.

Note

If you need to set the time zone or DST (Daylight Saving Time) or both, do so before setting the date and time.

- For details on the time zone and DST (Daylight Saving Time), page 2-182 in section 2.26.4, "Setting the Time Zone, Gradual Time Adjustment, and Daylight Saving Time".

Path

Web application: **Operation** tab > **Date/Time setting**

Description

Setup Item	Selectable Range or Options	Default Value
Date	2001 to 2035	—
Time	—	—

Date/time Settings

In the Date/Time settings dialog box, type the date and time.

The screenshot shows a dialog box titled "Date/Time Setting". It contains two input fields. The first field is labeled "Date (YYYY/MM/DD)" and contains the text "2014/ 12/ 05". The second field is labeled "Time (hh/mm/ss)" and contains the text "16: 37: 38". Below these fields are two buttons: "Update" and "Cancel".

2.3 Configuring AI Channels (Analog (including DI input) channels and AI (mA) channels)

Set the AI channels' and AI (mA) channels' input range, alarm, display, and calibration correction.

Set the necessary setup items in order from the top.

2.3.1 Setting the Range

Path

Web application: **Config.** tab > **AI channel settings*** > Channel range (display example: 0001-0010) > **Range**

Hardware configurator: **AI channel settings*** > Channel range (display example: 0001-0010) > **Range**

* AI channel settings or AI (mA) channel settings

Description

Range

Setup Item	Selectable Range or Options	Default Value
Type	Skip, Volt ⁴ /GS (general signal) ⁴ /TC (thermocouple) ⁴ /RTD (resistance temperature detector) ^{1, 4} /DI (contact, voltage level) ⁴ , current (0 to 20 mA) ³ , GS (4 to 20 mA) (general signal) ³ , resistance ⁷	Volt ⁶
Range ⁴	See "Range Details."	See "Range Details."
Span Lower	Numeric value (depends on the range)	-2.0000 ⁶
Span Upper	Numeric value (depends on the range)	2.0000 ⁶
Calculation	Off, Delta, Linear scaling, Square root, log input ⁵ , pseudo-log input ⁵ , linear-log input ⁵	Off ⁶
Reference channel ²	Number (I/O channel number)	—

- 1 Cannot be specified for channels on the electromagnetic relay type, low withstand voltage relay type or high withstand voltage type.
- 2 You can set this when Calculation is set to **Delta**.
- 3 Appears for AI (mA) channels.
- 4 Does not appear for AI (mA) channels.
- 5 Appears on models with the log scale (/LG) option when the range type is Volt.
- 6 The default values of AI (mA) channels are GS for Type, 4.000 for Span Lower, 20.000 for Span Upper, and Linear scaling for Calculation. The default values of the 4-wire RTD are -200.0 for span lower and 850.0 for span upper.
- 7 You can set this for 4-wire RTD/resistor type channels.

Type

Set the input signal type.

Options	Description
Skip	Not measured.
Volt, GS, TC, RTD, DI, current (0 to 20 mA), GS (4-20mA), resistance	Input type. Represents DC voltage, GS (0.4-2V, 1-5V inputs), thermocouple, RTD, ON/OFF input, current (0 to 20 mA), GS (4 to 20 mA general signal), and resistance, respectively.

Note

For electromagnetic relay type modules, set the range type to Skip for channels that will not be used.

Range

Set the input type range.

Range Details

Type	Range	Selectable Range	Default Value	Notes
Volt (DC voltage)	20 mV	-20.000 mV to 20.000 mV	2 V	
	60 mV	-60.00 mV to 60.00 mV		
	200 mV	-200.00 mV to 200.00 mV		
	1 V	-1.0000 V to 1.0000 V		
	2 V	-2.0000 V to 2.0000 V		
	6 V	-6.000 V to 6.000 V		
	20 V	-20.000 V to 20.000 V		
	50 V	-50.00 V to 50.00 V		
	100 V	-100.00 V to 100.00 V		
DI	LVL (level)	On (1)/off (0) (voltage)	LVL	On: 2.5 V or higher Off: 2.3 V or less
		DI (contact)		
GS (general signal)	0.4-2V	0.3200 V to 2.0800 V	1-5V	
	1-5V	0.800 V to 5.200 V		
DC current (0 to 20 mA)	—	0.000 mA to 20.000 mA	—	
GS (4 to 20 mA)	—	3.200 mA to 20.800 mA	—	
TC (thermocouple)	R	0.0°C to 1760.0°C	K	Type R
	S	0.0°C to 1760.0°C		Type S
	B	0.0°C to 1820.0°C		Type B
	K	-270.0°C to 1370.0°C		Type K
	K-H	-200.0°C to 500.0°C		Type K (high precision)
	E	-270.0°C to 800.0°C		Type E
	J	-200.0°C to 1100.0°C		Type J
	T	-270.0°C to 400.0°C		Type T
	N	-270.0°C to 1300.0°C		Type N
	W	0.0°C to 2315.0°C		Type W
	L	-200.0°C to 900.0°C		Type L
	U	-200.0°C to 400.0°C		Type U
	WRe3-25	0.0°C to 2320.0°C		Type WRe (WRe3-25)
	PLATINEL	0.0°C to 1395.0°C		
	PR20-40	0.0°C to 1900.0°C		
	KpvsAu7Fe	0.0K to 300.0K		Kp vs Au7Fe
NiNiMo	0.0°C to 1310.0°C			
W/WRe26	0.0°C to 2320.0°C	W/WRe26		
N14	0.0°C to 1300.0°C	Type N(AWG14)		
XK	-200.0°C to 600.0°C	XK GOST		

Continued on next page

2.3 Configuring AI Channels (Analog (including DI) input) channels and AI (mA) channels

Type	Range	Selectable Range	Default Value	Notes
RTD (resistance temperature detector)	Pt100	-200.0°C to 850.0°C	Pt100	
	Pt100-H	-150.00°C to 150.00°C		Pt100 (high resolution)
	JPt100	-200.0°C to 550.0°C		
	JPt100-H	-150.00°C to 150.00°C		JPt100 (high resolution)
	Cu10GE	-200.0°C to 300.0°C		Cu10(GE)
	Cu10LN	-200.0°C to 300.0°C		Cu10(L&N)
	Cu10WEED	-200.0°C to 300.0°C		Cu10(WEED)
	Cu10BAILEY	-200.0°C to 300.0°C		Cu10(BAILEY)
	Cu10a392	-200.0°C to 300.0°C		Cu10: $\alpha = 0.00392$ at 20°C
	Cu10a393	-200.0°C to 300.0°C		Cu10: $\alpha = 0.00393$ at 20°C
	Cu25	-200.0°C to 300.0°C		Cu25: $\alpha = 0.00425$ at 0°C
	Cu53	-50.0°C to 150.0°C		Cu53: $\alpha = 0.00426035$ at 0°C
	Cu100	-50.0°C to 150.0°C		Cu100: $\alpha = 0.00425$ at 0°C
	J263B	0.0K to 300.0K		J263*B
	Ni100SAMA	-200.0°C to 250.0°C		Ni100(SAMA)
	Ni100DIN	-60.0°C to 180.0°C		Ni100(DIN)
	Ni120	-70.0°C to 200.0°C		
	Pt25	-200.0°C to 550.0°C		
	Pt50	-200.0°C to 550.0°C		
	Pt200WEED	-100.0°C to 250.0°C		Pt200(WEED)
	Cu10G	-200.0°C to 200.0°C		Cu10 GOST
	Cu50G	-200.0°C to 200.0°C		Cu50 GOST
	Cu100G	-200.0°C to 200.0°C		Cu100 GOST
	Pt46G	-200.0°C to 550.0°C		Pt46 GOST
	Pt100G	-200.0°C to 600.0°C		Pt100 GOST
	Pt500	-200.0°C to 850.0°C		For the 4-wire RTD/resistor type
Pt1000	-200.0°C to 850.0°C			
Resistance	20 Ω	0.000 Ω to 20.000 Ω		For the 4-wire RTD/resistor type
	200 Ω	0.00 Ω to 200.00 Ω		
	2000 Ω	0.0 Ω to 2000.0 Ω		

Span Lower, Span Upper

Set the input range. The selectable range varies depending on the range setting. For the selectable ranges, see “Range Details.”

Note

- You cannot set the same value to **Span Lower** and **Span Upper**.

Calculation

When performing input calculation, set the calculation type.

Linear scaling

Converts the unit to obtain the measured value.

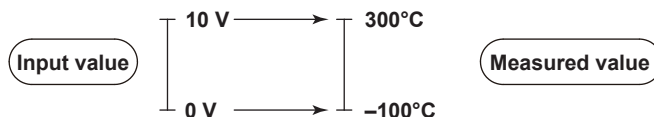

Delta

The measured value of the channel is set to the difference with respect to the measured value of the reference channel.

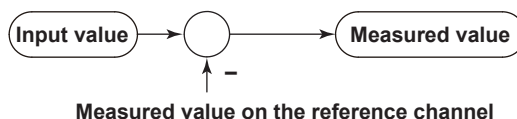

Note

Difference calculation is executed even if the input type or range is not the same between the difference calculation channel and the reference channel.

Differences in the decimal place is considered but the difference in the unit is ignored in the calculation. Then, the decimal place and the unit of the difference calculation channel are applied.

Example 1: If the input value of the difference calculation channel is 10.00 and the measured value of the reference channel is 100.0, the calculated result is 10.00 – 100.0 = –90.00.

Example 2: If the input value of the difference calculation channel is 10.00 V and the measured value of the reference channel is 5.00 mV, the computed result is 10.00 V – 5.00 mV = 5.00 V.

When the measurement mode is set to Dual interval

The measurement and computational processing between measurement groups is not synchronized. As such, if a difference calculation channel and the reference channel are in different measurement groups, it is indefinite as to which measured value of the reference channel in time will be used for the difference calculation.

Square Root

Takes the square root of the input value and converts the unit to obtain the measured value.

In a differential pressure flowmeter, the output signal is proportional to the square of the flow rate. Therefore, to measure on a recorder, square rooting is required.

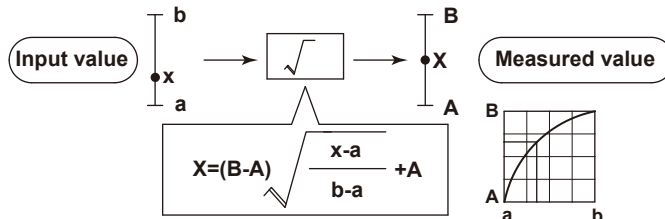

Reference Channel

Set the reference channel for the difference calculation. You cannot specify an AO channel.

Scale*

Setup Item	Selectable Range or Options	Default Value
Decimal place	0, 1, 2, 3, 4, 5	2
Scale Lower	-999999 to 999999	0.00
Scale Upper	-999999 to 999999	100.00
Unit	Character string (up to 6 characters, Aa#1)	—

* You can set this when math is set to **Linear scaling** or **Square root**.

Decimal Place

Set the decimal place of the scale for linear scaling and square rooting.

Scale Lower, Scale Upper

Assign values to the results of unit conversion of linear scaling and square rooting.

Note

- The GM converts measured values to values within the range set by the **Scale Lower** and **Scale Upper** values with their decimal points removed. For example, if the scale setting is “-5 to 5,” values are converted to values within the span of “10”; if the scale setting is “-5.0 to 5.0,” values are converted to values within a span of “100.” In this case, the resolution of values converted to a span of “10” is lower than those converted to a span of “100.”
- You cannot set the same value to **Scale Lower** and **Scale Upper**.

Unit

Set the unit.

Low-cut¹

Setup Item	Selectable Range or Options	Default Value
On/Off	Off, On	Off
Low-cut value ²	0.0% to 5.0%	0.0
Low-cut output ³	Output 0%, Output linear	Output 0%

- 1 You can set this when the type is set to **Volt** and Calculation is set to **Square root** or when the type is set to **GS** and Calculation is set to **Linear scaling** or **Square root**.
- 2 You can set this when On/Off is set to **On**.
- 3 You cannot set this when the type is set to **GS** and Calculation is set to **Linear scaling**.

On/Off

Select **On** to use the low-cut function.

Low-cut value

Set the low-cut value in the range of 0.0% to 5.0% of the input span.

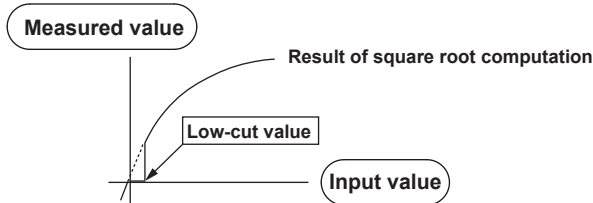

Low-cut output

Set the output value when the input is less than the low-cut value for when the low-cut function is in use.

Options	Description
Output 0%	Set the value for 0%.
Output linear	Outputs values that result by applying linear scaling to the input on the basis of the specified span and scale.

Note

When the type is set to **GS** and Calculation is set to **Linear scaling**, the low-cut output is fixed to **Output 0%**.

Moving Average

Setup Item	Selectable Range or Options	Default Value
On/Off	Off, On	Off
Count*	2 to 100 (2 to 500 for the high-speed AI module)	2

* You can set this when On/Off is set to **On**. You cannot set this when the type is set to **DI** (fixed to Off).

On/Off

Set this to **On** to perform moving average.

Count

Set the number of data points to take the moving average of.

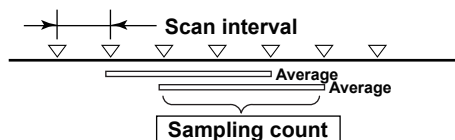

First-order lag filter (high-speed AI module only)

Setup Item	Selectable Range or Options	Default Value
On/Off *	Off/On	Off
Filter coefficient*	3 to 300	3

* You can set this when On/Off is set to **On**. You cannot set this when the type is set to **DI** (fixed to Off).

On/Off

Set this to **On** to use the first-order lag filter.

Filter coefficient

Filter time constant = scan interval × filter coefficient N

The following table shows the relationship between filter coefficient N of the first-order lag filter, scan interval, and time constant for filter coefficient N = 3, 10, 30, 100, and 300.

Scan interval	Time constant (s)				
	N=3	N=10	N=30	N=100	N=300
1ms	0.003	0.01	0.03	0.1	0.3
2ms	0.006	0.02	0.06	0.2	0.6
5ms	0.015	0.05	0.15	0.5	1.5
10ms	0.03	0.1	0.3	1	3
20ms	0.06	0.2	0.6	2	6
50ms	0.15	0.5	1.5	5	15
100ms	0.3	1	3	10	30
200ms	0.6	2	6	20	60
500ms	1.5	5	15	50	150
1s	3	10	30	100	300
2s	6	20	60	200	600
5s	15	50	150	500	1500

Description

When there is noise riding on the input signal, inserting a first-order lag filter has the effect of rejecting noise. The larger the filter coefficient (time constant), the higher the noise rejection effect. However, setting the filter coefficient too large will distort the waveform.

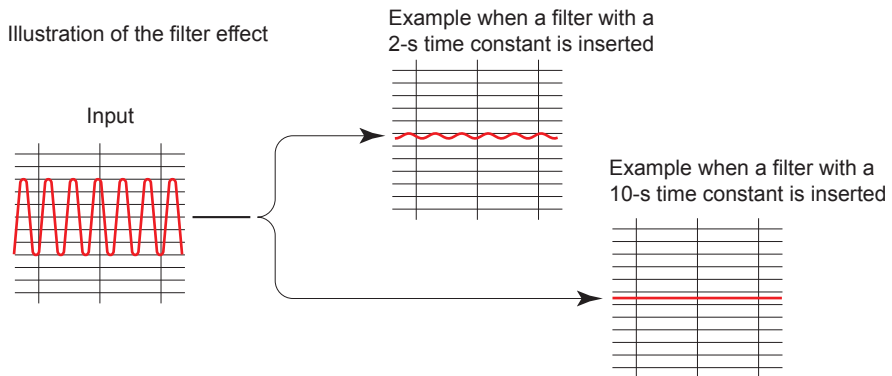
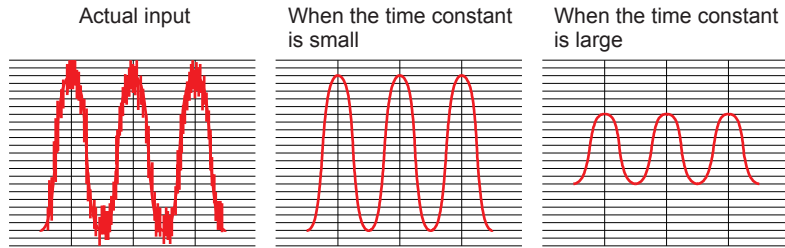

RJC^{1, 3} (Reference junction compensation)

Setup Item	Selectable Range or Options	Default Value
Mode	Internal/External	Internal
Temperature ²	-20.0 to 80.0°C, 253.1 to 353.2K (KpvsAu7Fe)	0.0°C, 273.2K (KpvsAu7Fe)

- 1 You can set this when the range type is set to **TC**.
- 2 You can set this when the mode is set to **External**.
- 3 You cannot set this for AI (mA) channels.

Mode

Set the reference junction compensation method of the thermocouple.

Options	Description
Internal	Uses the reference junction compensation function of the GM.
External	Uses an external reference junction compensation function.

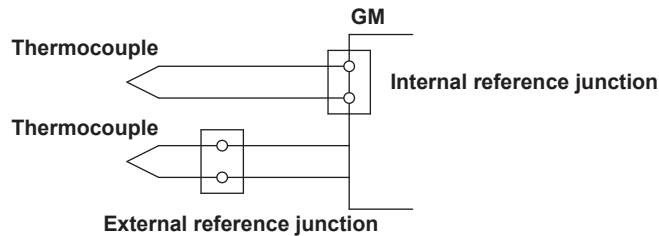

Temperature

When the RJC is set to external, set the compensation temperature.

Burnout set*

Setup Item	Selectable Range or Options	Default Value
Burnout	Off, Up, Down	Off

* You can set this when the range type is set to **GS**, **GS (4-20mA)**, **TC**, or **RTD**. It is not displayed for the 4-wire RTD/resistor type.

When the range type is set to **GS**, **GS (4-20mA)**, **TC**, or **RTD**, the GM detects sensor burnouts.

Options	Description
Off	Does not detect burnouts in the sensor.
Up	When the sensor burns out, the measured result is set to +over range. The measured value is displayed as "Burnout." When the input type is set to GS or GS (4-20mA) , the GM assumes that the sensor has burned out when the measured value moves out of the range defined by the upper and lower limits of burnout specified on the specified span width. (Example: If the lower limit of burnout is set to -10% and the upper limit to 110%, when the measured value is less than -10 or greater than 110 when the scale is set to 0 to 100 in linear scaling)
Down	When the sensor burns out, the measured result is set to -over range. The measured value is displayed as "Burnout." When the input type is set to GS or GS (4-20mA) , the GM assumes that the sensor has burned out when the measured value moves out of the range defined by the upper and lower limits of burnout specified on the specified span width. (Example: If the lower limit of burnout is set to -10% and the upper limit to 110%, when the measured value is less than -10 or greater than 110 when the scale is set to 0 to 100 in linear scaling)

► For details on setting the upper and lower limits of burnout, see page 2-103 in section 2.12.6, "Setting the Burnout Criteria".

Thermocouple Examples

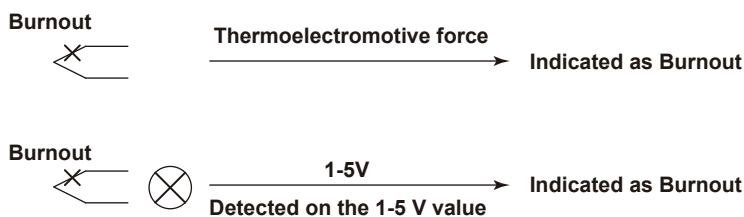

Note

If the scan interval is between 1 ms and 20 ms on a high-speed AI module, burnout detection will not work properly.

Bias*

Setup Item	Selectable Range or Options	Default Value
Bias	Numeric value (-999999 to 999999)	0

* You cannot set this when the range type is set to **DI**.

Set the bias to add to input values or linear scaling values (input calculation).

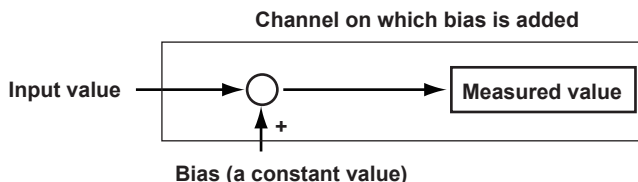

2.3.2 Setting Alarms

Path

Web application: **Config.** tab > **AI channel settings** or **AI (mA) channel settings** > Channel range (display example: 0001-0010) > **Alarm**

Hardware configurator: **AI channel settings** or **AI (mA) channel settings** > Channel range (display example: 0001-0010) > **Alarm**

Description

Level 1, Level 2, Level 3, Level 4

Setup Item	Selectable Range or Options	Default Value
On/Off	Off, On	Off
Type ¹	H: High limit, L: Low limit, R: High limit on rate-of-change, r: Low limit on rate-of-change, T: Delay high limit, t: Delay low limit, h: Difference high limit, ² l: Difference low limit ² , F: Profile high limit ⁸ , F: Profile high limit ⁸	H: High limit
Value ^{1,9}	Within the setting range	0.0000 ⁷
Hysteresis ^{1,4,9}	Numeric value When Calculation is set to Off or Delta : 0 to 5% of range setting When math is set to Linear scaling or Square root : 0 to 100000	0.0005 ⁷
Logging ¹	Off, On	On
Output type ¹	Off, Relay, ⁵ Internal switch ⁶	Off
Output No. ³	DO channel or internal switch	—

- 1 You can set this when Level (1 to 4) is set to **On**.
- 2 You can set this when Calculation of the range setting is set to Delta.
- 3 You can set this when Output type is not set to Off.
- 4 You can set this when the type is set to high limit, low limit, difference high limit, or difference low limit.
- 5 You can set this when the range type of any of the DO channels is set to Alarm.
- 6 You can set this when any of the internal switch type is set to Alarm.
- 7 The default values of AI (mA) channels are 0.00 for the Alarm value and 0.05 for Hysteresis.
- 8 Release number 5 and later. The communication channel function (/MC option) is included and the profile trend setting can be configured when **On**. You cannot set this when the range calculation is set to **LOG Input**, **Pseudo LOG Input**, or **LOG Linear Input**.
- 9 You cannot set this when the type is set to profile high limit or profile low limit.

On/Off

To use an alarm level (1 to 4), set this to **On**.

Type

Set the alarm type.

Options	Description
H: High limit	An alarm is activated when the measured value is greater than or equal to the alarm value.
L: Low limit	An alarm is activated when the measured value is less than or equal to the alarm value.
R: High limit on rate-of-change	An alarm is activated if the increasing rate-of-change of measured values over a certain interval is greater than or equal to the specified value.
r: Low limit on rate-of-change	An alarm is activated if the decreasing rate-of-change of measured values over a certain interval is greater than or equal to the specified value.
T: Delay high limit	An alarm is activated if measured values remain greater than or equal to the alarm value for a specified time period (delay period).
t: Delay low limit	An alarm is activated if measured values remain less than or equal to the alarm value for a specified time period (delay period).
h: Difference high limit	An alarm is activated when the difference in the measured values of two channels is greater than or equal to the specified value. This alarm can be specified on measurement channels set to difference calculation.
l: Difference low limit	An alarm is activated when the difference in the measured values of two channels is less than or equal to the specified value. This alarm can be specified on measurement channels set to difference calculation.
F: Profile high limit	An alarm is activated when the measured value is greater than or equal to the profile high limit.
f: Profile low limit	An alarm is activated when the measured value is less than or equal to the profile low limit.

Alarms of channels set to difference calculation are set in the position shown in the figure below.



Value

Set the alarm value for the specified alarm type.

Options	Value	Examples of Alarm Value Range
H, L	A value within the measurable range	-2.0000 to 2.0000 V for 2 V range -270.0 to 1370.0°C for thermocouple type K
R, r	1 digit to the upper limit of the width of the measurable range	0.0001 to 4.0000 V for 2 V range 0.1 to 1640.0°C for thermocouple type K
T, t	Same as H and L	Same as H and L

When the Channel Calculation Is Set to Delta

Options	Value	Examples of Alarm Value Range
H, L	A value within the measurable range	-2.0000 to 2.0000 V for 2 V range -270.0 to 1370.0°C for thermocouple type K
h, l	A value within the measurable range	-4.0000 to 4.0000 V for 2 V range -1640.0 to 1640.0°C for thermocouple type K
R, r	1 digit to the upper limit of the width of the measurable range	0.0001 to 4.0000 V for 2 V range 0.1 to 1640.0°C for thermocouple type K
T, t	Same as H and L	Same as H and L

When the Channel Calculation Is Set to Linear Scaling or Square Root

Options	Value	Examples of Alarm Value Range
H, L	-5% to 105% of the scale width However, within -999999 to 999999 excluding the decimal point.	When the scale is 0.0 to 100.0: -5.0 to 105.0 When the scale is -100.00 to 300.00: -120.00 to 320.00
R, r	1 to the scale width but within 1 to 999999 excluding the decimal point.	When the scale is 0.0 to 100.0: 0.1 to 100.0 When the scale is -100.00 to 300.00: 0.01 to 400.00
T, t	Same as H and L	Same as H and L

Hysteresis

Set this to establish an offset between the value used to activate and release alarms. This is fixed at 0 for the DI range.

Example:

H: If you set the alarm value of a high limit alarm to 1.0000 V and the hysteresis to 0.0005 V, an alarm is activated when the measured value is greater than or equal to 1.0000 V and is released when the measured value is less than 0.9995 V.

Logging

Set this **On** to display an alarm (notify you) when an alarm occurs. If set to **Off**, when an alarm occurs, the GM outputs signals to alarm output DO channels or internal switches but does not display the alarm. In addition, alarms are also not recorded in the alarm summary.

Output type

Set the alarm output destination.

Alarm status can be output to the relay (DO channel) or internal switches (100 software switches). Internal switch values are shown below. Like the DO output relay, you can specify AND/OR operation.

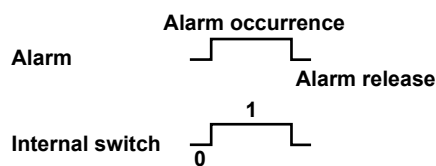

Internal switches can be used as events of the event action function (see page 2-135 in section 2.20, “Configuring the Event Action Function”). In addition, they can also be written in calculation expressions of math channels (/MT option).

Output No.

Set the number of the relay (DO channel) or internal switch to output alarms to.

Profile channel (Release number 5 and later) *

Setup Item	Selectable Range or Options	Default Value
High limit	Off, Communication channel	Off
Reference	Same as High limit	Off
Low limit	Same as High limit	Off

* You can set this when the communication channel function (/MC option) is included.

High limit

Sets the communication channel through which the high limit data of the profile trend is loaded.

Reference

Sets the communication channel through which the reference data of the profile trend is loaded.

Lower limit

Set the communication channel through which the low limit data of the profile trend is loaded.

Note

- You must load the profile trend in advance to read the trend data.
- Set the profile channel to the same channel as the channel number of the loaded profile trend.
- You can only set this when On/Off is set to the On communication channel.

Alarm delay (for delay high and low limit alarms)*

Setup Item	Selectable Range or Options	Default Value
Hour	1 to 24	0
Minute	0 to 59	0
Second	0 to 59	10

* You can set this when Level 1, Level 2, Level 3, or Level 4 is On.

Hour, Minute, and Second

Set the alarm delay. These values are valid when the delay high limit or delay low limit is in use.

Explanation

Alarm Type

The character inside the parentheses is the symbol denoting each alarm.

High limit (H)	Lower limit (L)
Delay high limit (T)	Delay low limit (t)
High limit on rate-of-change (R)	Low limit on rate-of-change (r)
Difference high limit (h)	Difference low limit (l)
Profile high limit (F)	Profile low limit (f)

High Limit Alarm and Low Limit Alarm

An alarm is activated when the measured value is greater or less than or equal to the alarm value.

Delay High Limit Alarm and Delay Low Limit Alarm

An alarm is activated if measured values remain greater or less than or equal to the alarm value for a specified time period (delay period).

High Limit on Rate-of-Change Alarm and Low Limit on Rate-of-Change Alarm

An alarm is activated if the increasing or decreasing rate-of-change of measured values over a certain interval is greater than or equal to the specified value.

The alarm value of a rate-of-change alarm is set using an absolute value. The interval is derived using the following equation and set using the number of samples.

Interval = the scan interval × the number of samples

- For the number of samples, see page 2-181 in section 2.26.2, “Setting the Interval for Calculating the Rate-of-Change for Rate-of-Change Alarms”.

Difference High Limit Alarm and Difference Low Limit Alarm

An alarm is activated when the difference in the measured values of two channels is greater or less than or equal to the specified value.

This alarm can be specified on measurement channels set to difference calculation.

Profile high limit alarm, profile low limit alarm (Release number 5 and later)

An alarm is triggered when the measured value is greater than or equal to the profile trend high limit or than or equal to the profile trend low limit.

Alarm Detection and Output When the Scan Interval Is Shorter Than 100 ms

Alarm is detected every 100 ms. All alarms that occur in each 100 ms interval are detected and recorded in the alarm summary. Internal switch and relay output generated by alarms occur at 100 ms intervals.

2.3.3 Setting the Display

Path

Web application: **Config**. tab > **AI channel settings** or **AI (mA) channel settings** > Channel range (display example: 0001-0010) > **Display settings**

Hardware configurator: **AI channel settings** or **AI (mA) channel settings** > Channel range (display example: 0001-0010) > **Display settings**

Description

Tag

Setup Item	Selectable Range or Options	Default Value
Characters	Character string (up to 32 characters, Aa#1)	—
No.	Character string (up to 16 characters, Aa#1)	—

Characters

Set the tag.

Not all characters may be displayed due to space constraints.

No.

Set the tag number.

Color

Setup Item	Selectable Range or Options	Default Value
Color	24 colors (red, green, blue, blue violet, brown, orange, yellow-green, light blue, violet, gray, lime, cyan, dark blue, yellow, light gray, purple, black, pink, light brown, light green, dark gray, olive, dark cyan, and spring green) and a user-defined color (1 color)	—

Color

Set channel display colors. The colors apply to the trend display and bar graph display.

Zone

Setup Item	Selectable Range or Options	Default Value
Lower	0 to 95%	0
Upper	5 to 100 %	100

Lower and Upper

Set these values when you want to divide the waveform displays of channels into separate zones so that waveforms do not overlap. Set the **Lower** and **Upper** positions as percentages of the maximum display width. Set **Lower** to a value less than **Upper**, and set the zone width (**Upper – Lower**) to be 5% or greater.

Example:

Set the channel 1 zone to 0 to 30%, the channel 2 zone to 30 to 60%, and the channel 3 zone to 60 to 100%.

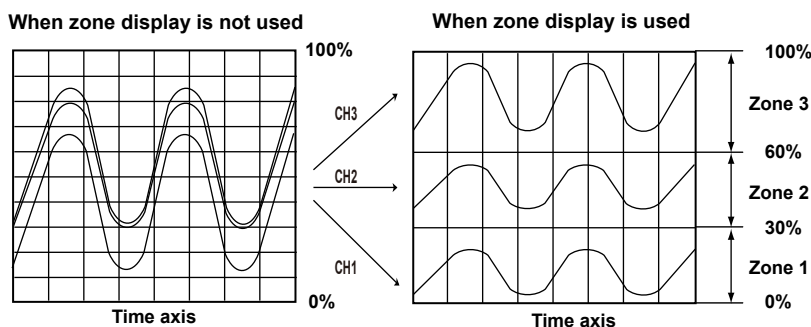

Bar graph

Setup Item	Selectable Range or Options	Default Value
Base position	Lower, Center, Upper	Lower

Base position

Set the bar graph base position. Depending on the setting, the bar graph is displayed as follows. This setting is applied on the bar graph display.

When the Display Direction of the Bar Graph Is Vertical

The span lower limit (or scale lower limit) is at the bottom edge of the bar graph, and the span upper limit (or scale upper limit) is at the top edge of the bar graph.

Starting point of the bar

Center: Center

Lower: Bottom edge

Upper: Top edge

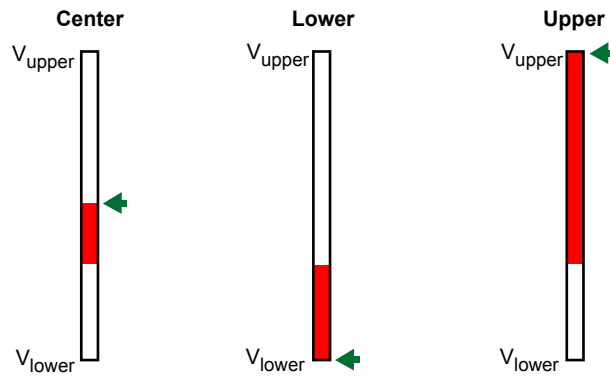

V_{upper}: Span upper limit (or scale upper limit)

V_{lower}: Span lower limit (or scale lower limit)

← : Starting point of the bar

Example: When the span lower and upper limits of the input range are 0.0 and -100.0, respectively

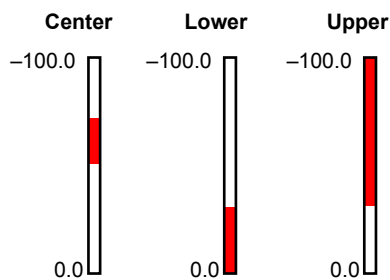

When the Display Direction of the Bar Graph Is Horizontal

The span lower limit (or scale lower limit) is at the left edge of the bar graph, and the span upper limit (or scale upper limit) is at the right edge of the bar graph.

Starting point of the bar

- Center: Center
- Lower: Left edge
- Upper: Right edge

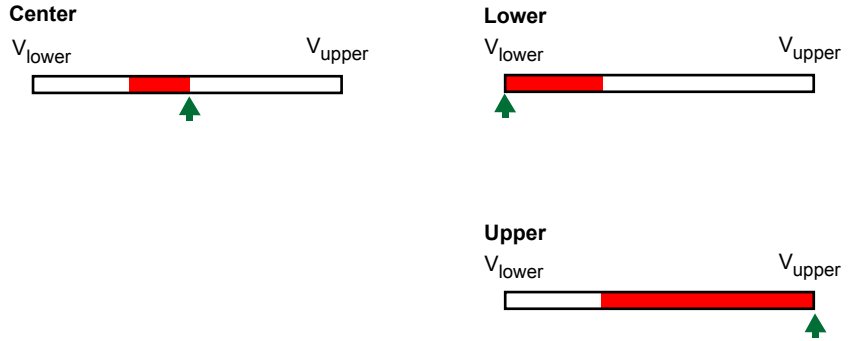

V_{upper} : Span upper limit (or scale upper limit)
 V_{lower} : Span lower limit (or scale lower limit)
 ▲: Starting point of the bar

Example: When the span lower and upper limits of the input range are 0.0 and -100.0, respectively

Center 0.0 -100.0

Lower 0.0 -100.0

Upper 0.0 -100.0

The example shows three horizontal bar graphs. The first, labeled 'Center', has a red bar starting from the center between 0.0 and -100.0. The second, labeled 'Lower', has a red bar starting from the left edge (0.0). The third, labeled 'Upper', has a red bar starting from the right edge (-100.0).

When Displaying the Current Value on the Scale Using the Bar Graph

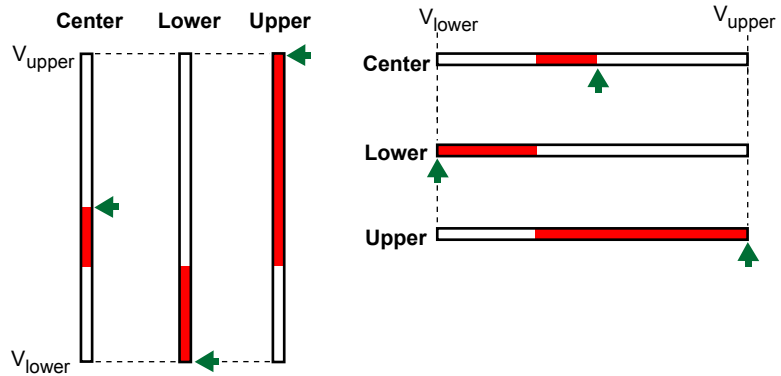

Color scale band

Setup Item	Selectable Range or Options	Default Value
Band area	Off, In, Out	Off
Color	24 colors (red, green, blue, blue violet, brown, orange, yellow-green, light blue, violet, gray, lime, cyan, dark blue, yellow, light gray, purple, black, pink, light brown, light green, dark gray, olive, dark cyan, and spring green) and a user-defined color (1 color)	—
Display position Lower	Span (scale) lower limit to span (scale) upper limit	0.0000
Display position Upper	Span (scale) lower limit to span (scale) upper limit	0.0100

Band area

Displays a specified section of the measurement range using a color band on the scale. This setting is shared with the bar graph display.

Options	Description
Off	Disables the function.
In	Displays the area inside using the color band.
Out	Displays the area outside using the color band.

Color

Set the display color.

- For instructions on how to set the user-defined color, see “Operation Example 2” on page 2-13.

Display position Lower and Display position Upper

Set the display position. Set a value within the span or scale range.

Alarm point mark



Setup Item	Selectable Range or Options	Default Value
Indicate on scale	Off, On	On
Mark kind	Alarm, Fixed	Alarm
Alarm 1 color to Alarm 4 color*	24 colors (red, green, blue, blue violet, brown, orange, yellow-green, light blue, violet, gray, lime, cyan, dark blue, yellow, light gray, purple, black, pink, light brown, light green, dark gray, olive, dark cyan, and spring green) and a user-defined color (1 color)	—

* You can set this when the Mark kind is set to **Fixed**.

Indicate on scale

Set this to **On** to display alarm point marks on the scale. Set this to **Off** to not display them. This setting is shared with the bar graph display.

Mark kind

Options	Description	Mark Shape
Alarm	Displayed normally in green. Displayed in red when an alarm occurs.	 or 
Fixed	Displayed with a fixed color.	

Alarm 1 color to Alarm 4 color

When Mark kind is set to **Fixed**, set the display colors of point marks for alarm levels 1 to 4.

Display characters of each value

Setup Item	Selectable Range or Options	Default Value
0	Character string (up to 8 characters, Aa#1)	—
1	Character string (up to 8 characters, Aa#1)	—

* You can set this when in the range settings, type is set to **DI** and Calculation is set to **Off**.

0

Set the character string to display when the measured value is 0.

1

Set the character string to display when the measured value is 1.

Examples of display characters of each value

Receive a device operation status through DI input and display measured values (0 and 1) as “Running” and “Stopped.”

You can select whether to display measured values (0 or 1) or characters.

Explanation

Group Display

On the trend, digital, bar graph, and horizontal bar graph displays, the data of channels is displayed in groups that are set in advance.

Groups are shared among the trend, digital, bar graph, and horizontal bar graph displays.

The displayed group can be switched automatically at a specified time interval (5 s to 1 min).

Number of Groups That Can Be Registered

GM10-1: 50 groups

GM10-2: 60 groups

Number of Channels That Can Be Assigned to a Group

Up to 20 channels

Update Interval of Measured Values

Values are updated every 1 second. However, if the scan interval is greater than 1 s, values are updated at the scan interval.

Alarm Indication

Alarms that are set for each channel are checked at all times and are indicated with the symbol representing the alarm type on each display.

Alarm Type	Symbol
High limit alarm	H
Low limit alarm	L
Difference high limit alarm	h
Difference low limit alarm	l (lowercase L)
High limit on rate-of-change alarm	R
Low limit on rate-of-change alarm	r
Delay high limit alarm	T
Delay low limit alarm	t
Profile high limit alarm	F
Profile low limit alarm	f

Trend Display (T-Y)

Measured data is displayed in a waveform.

- ▶ For details on the display, see “Trend Monitor, Digital Monitor, Bar Graph Monitor, and Horizontal Bar Graph Monitor” on page 3-12.

Digital Display

The digital display shows measured data using large numbers.

- ▶ For details on the display, see “Trend Monitor, Digital Monitor, Bar Graph Monitor, and Horizontal Bar Graph Monitor” on page 3-12.

Note

- Numeric display of analog input channels
If a measured value of an analog input channel is over range (see below), the measured value is indicated as “+Over” or “-Over.” If a burnout is detected on a channel whose burnout detection function is enabled, the word “Burnout” is indicated. If you remove a module or use a module in error, “*****” is displayed. For all other cases, a numeric value is displayed.
Over range of analog input channels
 - An over range occurs when the measured value of an analog input channel exceeds $\pm 5\%$ of the measurable range. For example, the measurable range when the measurement range is 2 V is -2.000 to 2.000 V. If the measured value exceeds 2.200 V, +over range occurs; if the measured value falls below -2.200 V, -over range occurs.
 - For a channel using Linear scaling or Square root, over range occurs if the measured value falls outside the -5% to 105% range of the specified span. You can also change the setting so that over range occurs when the measured value falls outside the -5% to 105% range of the measurable span range. However, +over range occurs if the value excluding the decimal point exceeds 999999 and -over range if it falls below -999999 .
- ▶ Setup: See page 2-99 in section 2.12.2, “Setting the Over-range Detection Method”.

Bar Graph Display

Measured data is displayed in a bar graph.

- ▶ For details on the display, see “Trend Monitor, Digital Monitor, Bar Graph Monitor, and Horizontal Bar Graph Monitor” on page 3-12.

- **Bar Graph Updating**

The bar graph is updated at the same interval as numeric values.

2.3.4 Setting Calibration Correction (Linearizer approximation, linearizer bias, Correction factor* (release number 3 and later))

* /AH option only

Path

Web application: **Config.** tab > **AI channel settings** or **AI (mA) channel settings** >

Channel range (display example: 0001-0010) > **Calibration correction**

Hardware configurator: **AI channel settings** or **AI (mA) channel settings** > Channel range

(display example: 0001-0010) > **Calibration correction**

Description

Mode

Setup Item	Selectable Range or Options	Default Value
Mode	Off, Linearizer Approximation, Linearizer Bias, Correction Factor	Off
Number of set points*	2 to 12	2
Edit correction points*	Use the Edit correction points button to display a calibration correction dialog box.	—

* You can set this when the mode is not set to **Off**.

Mode

Set the correction mode when performing calibration correction.

When the range is set to DI or Skip, the mode is fixed to Off.

Number of set points

Set the number of points that make up the segments (including the start and end points).

Edit correction points: Linearizer approximation or linearizer bias (1 to 12*)

Setup Item	Selectable Range or Options	Default Value
Linearizer input	–999999 to 999999	—
Linearizer output	–999999 to 999999	—
Execution of the input measurement	—	—

* The number of displayed points varies depending on the number of set points.

Linearizer input, Linearizer output

Enter the value of the set point. For linearizer input, set a value that is greater than the previous value.

Selectable Range of Linearizer Input and Output Values

- Channels using linear scaling
–999999 to 999999 (the decimal place is the same as that for the scale value)
- Other channels
Values inside parentheses are examples for the 2 V range.

Linearizer approximation

Selectable range of linearizer input: Measurable range (–2.0000 to 2.0000 V)

Selectable range of linearizer output: Display range (–2.2000 to 2.2000 V)

Linearizer bias

Selectable range of linearizer input: Measurable range (–2.0000 to 2.0000 V)

Selectable range of linearizer output: Measurement span width \pm 100% (–4.0000 to 4.0000 V)

Edit correction points: Correction factor (1 to 12*) (/AH option only)

Setup Item	Selectable Range or Options	Default Value
Uncorrected value	-999999 to 999999	—
Instrument correction factor	-999999 to 999999	—
Sensor correction factor	-999999 to 999999	—
Execution of the input measurement	—	—

* The number of displayed points varies depending on the number of set points.

Uncorrected value

Enter the uncorrected value. Set a value that is greater than the previous value.

- Channels using linear scaling or open/close computation
–999999 to 999999 (the decimal place is the same as that for the scale value)
- Other channels
Values inside parentheses are examples for the 2 V range.
Measurable range (–2.0000 to 2.0000 V)

Instrument correction factor

Set the instrument-dependent correction factor.

- Channels using linear scaling
–999999 to 999999 (the decimal place is the same as that for the scale value)
- Other channels
Values inside parentheses are examples for the 2 V range.
Measurement span width $\pm 100\%$ (–4.0000 to 4.0000 V)

Sensor correction factor

Set the sensor-dependent correction factor.

- Channels using linear scaling
–999999 to 999999* (the decimal place is the same as that for the scale value)
* Make sure that the sum of this factor and the instrument correction factor does not exceed this range.
- Other channels
Values inside parentheses are examples for the 2 V range.
Measurement span width $\pm 100\%$ (–4.0000 to 4.0000 V)*
* Make sure that the sum of this factor and the instrument correction factor does not exceed this range.

Execution of the input measurement

The uncorrected value is set to the current measured value.

Procedure

Click Linearizer **Edit correction points** to display the AI channel[XXXX] Calibration correction dialog box.

Click **Execute** to set the linearizer input value to the current measured value.

If the mode is set to correction factor, the linearizer input value is set to uncorrected value.

Linearizer approximation, linearizer bias

Linearizer input/output	Linearizer input	Linearizer output	Execution of the input measurement
1	-2.0000	-2.0000	Execute
2	-1.6364	-1.6364	Execute
3	-1.2727	-1.2727	Execute
4	-0.9091	-0.9091	Execute
5	-0.5455	-0.5455	Execute
6	-0.1818	-0.1818	Execute
7	0.1818	0.1818	Execute
8	0.5455	0.5455	Execute
9	0.9091	0.9091	Execute
10	1.2727	1.2727	Execute
11	1.6364	1.6364	Execute
12	2.0000	2.0000	Execute

Correction factor

Correction points	Uncorrected value	Instrument correction factor	Sensor correction factor	Execution of the input measurement
1	-2.0000	0.0000	0.0000	Execute
2	-1.6364	0.0000	0.0000	Execute
3	-1.2727	0.0000	0.0000	Execute
4	-0.9091	0.0000	0.0000	Execute
5	-0.5455	0.0000	0.0000	Execute
6	-0.1818	0.0000	0.0000	Execute
7	0.1818	0.0000	0.0000	Execute
8	0.5455	0.0000	0.0000	Execute
9	0.9091	0.0000	0.0000	Execute
10	1.2727	0.0000	0.0000	Execute
11	1.6364	0.0000	0.0000	Execute
12	2.0000	0.0000	0.0000	Execute

Executes input measurement

Note

- If you change the **Mode** or **Range** setting, the calibration correction setting is set to Off.
- Calibration correction cannot be specified on channels set to **Skip** or **DI**.

Explanation

Linearizer Approximation

Corrects input values using characteristics specified with segments to derive output values.

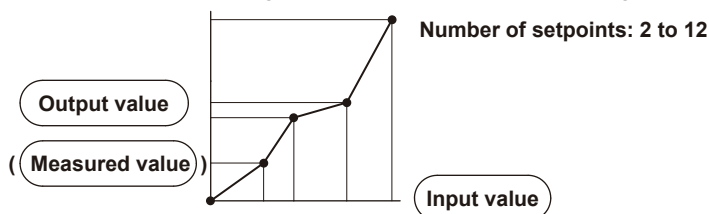

Linearizer Bias

Corrects input values using bias values specified with segments to derive output values.

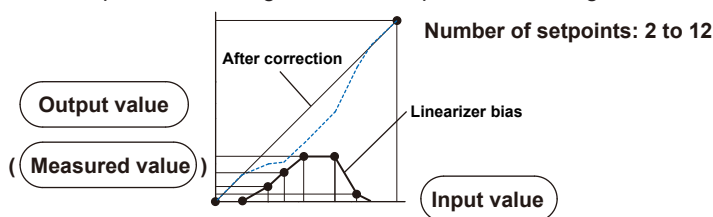

Correction Factor

Corrects input values using the instrument correction factor and sensor correction factor specified with segments to derive output values.

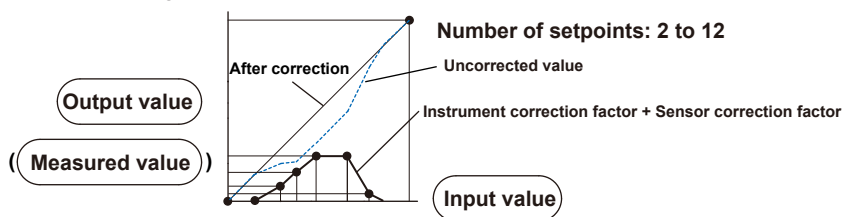

2.4 Configuring DI Channels (Digital input channels)

Set the input range, alarm, and display conditions of DI channels (including the DI channels of DI/DO modules).

To use the DI module as a remote control input, set the operation mode of the module to Remote. ▶ See page 2-99 in section 2.12.3, “Setting the Operation Mode of a Module”. Set the remote control action using event action. ▶ See page 2-135 in section 2.20, “Configuring the Event Action Function”.

2.4.1 Setting the Range

Path

Web application: **Config.** tab > **DI channel settings*** > Channel range (display example: 0501-0516) > **Range**

Hardware configurator: **DI channel settings** > Channel range (display example: 0501-0516) > **Range**

Description

Range

Setup Item		Selectable Range or Options	Default Value
Type		Skip, DI, Pulse ²	DI
Span Lower	DI	0, 1 Delta: -1 to 1	0
	Pulse	0 to 999999 (decimal place: 0)	0
Span Upper	DI	0, 1 Delta: -1 to 1	1
	Pulse	0 to 999999 (decimal place: 0)	1250
Calculation		Off, ³ Delta, Linear scaling	Off
Reference channel ¹		Value (I/O channel)	—

1 You can set this when Calculation is set to Delta.

2 You can set this when the GM10 has the /MT option and the operation mode is set to Normal.

3 This is fixed to Off when the Type is set to Pulse.

Type

Set the input type.

Options	Description
Skip	Not measured.
DI	Displays contact input or voltage input signals by mapping them to 0% or 100% of the display range.
Pulse	Counts pulses. Maximum measurement pulse cycle: 250 Hz (chattering filter for pulse input: off) 125 Hz (chattering filter for pulse input: on)

▶ For details on the chattering filter for pulse input, see page 2-103 in section 2.12.7, “Setting the Chattering Filter for Pulse Input”.

Span Lower, Span Upper

Set the input range.

Calculation

When performing input calculation, set the calculation type. You can set this when the range type is set to **DI**.

▶ For details on the input calculation function, see section 2.3.1, “Setting the Range”.

Reference channel

Set the reference channel for the difference calculation.
You cannot specify an AO channel.

Scale*

Setup Item	Selectable Range or Options	Default Value
Decimal place	0, 1, 2, 3, 4, 5	2
Scale Lower	-999999 to 999999	0.00
Scale Upper	-999999 to 999999	100.00
Unit	Character string (up to 6 characters, $\boxed{\text{Aa\#1}}$)	—

* You can set this when the range is set to **DI** and Calculation is set to **Linear scaling**.

Decimal Place

Set the decimal place of the scale for linear scaling.

Scale Lower, Scale Upper

Assign values to the results of unit conversion of linear scaling.

Unit

Set the unit.

2.4.2 Setting Alarms

Path

Web application: **Config**. tab > **DI channel settings** > Channel range (display example: 0501-0516) > **Alarm**

Hardware configurator: **DI channel settings** > Channel range (display example: 0501-0516) > **Alarm**

Description

Level 1, Level 2, Level 3, Level 4

Setup Item	Selectable Range or Options	Default Value
On/Off	Off/On	Off
Type ¹	H: High limit, L: Low limit, R: High limit on rate-of-change, r: Low limit on rate-of-change, T: Delay high limit, t: Delay low limit, h: Difference high limit ² , l: Difference low limit ² , F: Profile high limit ⁵ , f: Profile low limit ⁵	Off
Value ^{1,6}	Within the setting range	0
Hysteresis ^{1,4,6}	0 (fixed)	0
Logging ¹	Off, On	On
Output type ¹	Off, Relay, Internal switch	Off
Output No. ³	DO channel or internal switch number	—

1 You can set this when Level (1 to 4) is set to **On**.

2 You can set this when Calculation of the range setting is set to **Delta**.

3 You can set this when Output type is not set to Off.

4 You can set this when the type is set to high limit, low limit, difference high limit, or difference low limit.

5 Release number 5 and later. The communication channel function (/MC option) is included and the profile trend setting can be configured when **On**.

6 You cannot set this when the type is set to profile high limit or profile low limit.

On/Off

To use an alarm level (1 to 4), set this to **On**.

Type

Set the alarm type.

► For details, see page 2-32 in section 2.3.2, “Setting Alarms”.

Alarms of channels set to difference calculation are set in the position shown in the figure below.

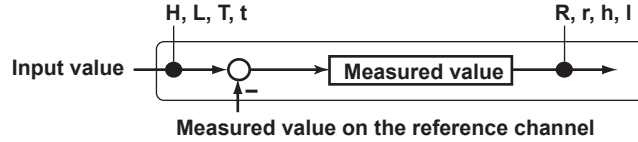

Value

Set the alarm value for the specified alarm type.

► For details, see page 2-32 in section 2.3.2, “Setting Alarms”.

Hysteresis

Fixed to 0.

Logging

Set this **On** to display an alarm (notify you) when an alarm occurs. If set to **Off**, when an alarm occurs, the GM outputs signals to alarm output DO channels or internal switches but does not display the alarm. Alarms are also not recorded in the alarm summary.

Output type

Set the alarm output destination.

Output No.

Set the number of the DO channel or internal switch to output alarms to.

Profile channel (Release number 5 and later) *

Setup Item	Selectable Range or Options	Default Value
High limit	Off, Communication channel	Off
Reference	Same as High limit	Off
Low limit	Same as High limit	Off

* You can set this when the communication channel function (/MC option) is included.

High limit

Sets the communication channel through which the high limit data of the profile trend is loaded.

Reference

Sets the communication channel through which the reference data of the profile trend is loaded.

Lower limit

Set the communication channel through which the low limit data of the profile trend is loaded.

Note

- You must load the profile trend in advance to read the trend data.
- Set the profile channel to the same channel as the channel number of the loaded profile trend.
- You can only set this when On/Off is set to the On communication channel.

Alarm delay (for delay high/low limit alarms) *

Setup Item	Selectable Range or Options	Default Value
Hour	1 to 24	0
Minute	0 to 59	0
Second	0 to 59	10

* You can set this when Level 1, Level 2, Level 3, or Level 4 is On.

Hour, Minute, and Second

Set the alarm delay. These values are valid when the delay high limit or delay low limit is in use.

2.4.3 Setting the Display

Path

Web application: **Config.** tab > **DI channel settings** > Channel range (display example: 0501-0516) > **Display settings**

Hardware configurator: **DI channel settings** > Channel range (display example: 0501-0516) > **Alarm** > **Display settings**

Description

Tag

Setup Item	Selectable Range or Options	Default Value
Characters	Character string (up to 32 characters, Aa#1)	—
No.	Character string (up to 16 characters, Aa#1)	—

Characters

Set the tag.

Not all characters may be displayed due to space constraints.

No.

Set the tag number.

Color

Setup Item	Selectable Range or Options	Default Value
Color	24 colors (red, green, blue, blue violet, brown, orange, yellow-green, light blue, violet, gray, lime, cyan, dark blue, yellow, light gray, purple, black, pink, light brown, light green, dark gray, olive, dark cyan, and spring green) and a user-defined color (1 color)	—

Color

Set channel display colors. The colors apply to the trend display and bar graph display.

- For instructions on how to set the user-defined color, see “Operation Example 2” on page 2-13.

Zone

Setup Item	Selectable Range or Options	Default Value
Lower	0 to 95%	0
Upper	5 to 100 %	100

Lower and Upper

Set these values when you want to divide the waveform displays of channels into separate zones so that waveforms do not overlap. Set the **Lower** and **Upper** positions as percentages of the maximum display width. Set **Lower** to a value less than **Upper**, and set the zone width (**Upper – Lower**) to be 5% or greater.

Bar graph

Setup Item	Selectable Range or Options	Default Value
Base position	Lower, Center, Upper	Lower

Base position

Set the bar graph base position. This setting is applied on the bar graph display.

- For display examples, see “Trend Monitor, Digital Monitor, Bar Graph Monitor, and Horizontal Bar Graph Monitor” on page 3-12.

Alarm point mark



Setup Item	Selectable Range or Options	Default Value
Indicate on Scale	Off/On	On
Mark kind	Alarm, Fixed	Alarm
Alarm 1 color to Alarm 4 color*	24 colors (red, green, blue, blue violet, brown, orange, yellow-green, light blue, violet, gray, lime, cyan, dark blue, yellow, light gray, purple, black, pink, light brown, light green, dark gray, olive, dark cyan, and spring green) and a user-defined color (1 color)	—

* You can set this when the Mark kind is set to **Fixed**.

Indicate on Scale

Set this to **On** to display alarm point marks on the scale. Set this to **Off** to not display them. This setting is shared with the bar graph display.

Mark kind

Options	Description	Mark Shape
Alarm	Displayed normally in green. Displayed in red when an alarm occurs.	 or 
Fixed	Displayed with a fixed color.	

Alarm 1 color to Alarm 4 color

When Mark kind is set to **Fixed**, set the display colors of point marks for alarm levels 1 to 4.

Display characters of each value*

Setup Item	Selectable Range or Options	Default Value
0	Character string (up to 8 characters, Aa#1)	—
1	Character string (up to 8 characters, Aa#1)	—

* You can set this when the range set to **DI** and Calculation is set to **Off**.

0

Set the character string to display when the measured value is 0.

1

Set the character string to display when the measured value is 1.

- For usage examples, see page 2-36 in section 2.3.3, “Setting the Display”.

2.5 Configuring Pulse Input Channels (Release number 3 and later)

Set the input range, alarm, and display conditions of pulse input channels and display conditions.

To perform pulse input integration, the computation (/MT) option is required.

- ▶ For details on the computation, see page 2-70 in section 2.9, “Configuring Math Channels (/MT option)”.
- ▶ For computation examples, see page App-26 in section Appendix 6, “Computation Examples Using Pulse Input”.

2.5.1 Setting the Range

Path

Web application: **Config. tab > Pulse input channel settings > Channel range** (display example: 0501-0510) > **Range**

Hardware configurator: **Pulse input channel settings > Channel range** (display example: 0501-0510) > **Range**

Description

Range

Setup Item	Selectable Range or Options	Default Value
Type	Skip, Pulse	Pulse
Range	Level, Contact	Level
Chattering filter	Off, On	On
Span Lower	0 to 200000 Delta: -200000 to 200000	0
Span Upper	0 to 200000 Delta: -200000 to 200000	200000
Calculation	Off, Delta, Linear scaling	Off
Reference channel*	Number (I/O channel number)	—

* You can set this when Calculation is set to Delta.

Type

Set the input type.

Options	Description
Skip	Not measured.
Pulse	Counts pulses.

Range

Set the pulse input range.

Options	Description
Level	Voltage (5 V logic) (counted when a change from 1 V or lower to 3 V or higher is detected)
Contact	Contact input (counted when a change from 100 k Ω or higher to 200 Ω or lower is detected)

Chattering filter

This filter prevents pulse count errors caused by chattering or noise.

Options	Description
Off	The chattering filter is not used.
On	The chattering filter is used.

Note

When the chattering filter is set to **On**, the input range can be up to 30 Hz.

Span Lower, Span Upper

Set the input range. You cannot set the same value to Span Lower and Span Upper.

- When Calculation is set to **Off** or **Linear scaling**.
0 to 200000
- When Calculation is set to **Delta**.
-200000 to 200000

Example: Measured value per scan interval when 10000 (pulse/s) is input

Scan interval	100 ms	200 ms	500 ms	1s	2s	5s
Measured value	1000	2000	5000	10000	20000	50000

Calculation

When performing input calculation, set the calculation type.

▶ See page 2-27 in section , “Calculation”.

- **Linear scaling**

Converts the unit to obtain the measured value.

- **Delta**

The measured value of the channel is set to the difference with respect to the measured value of the reference channel.

Reference Channel

Set the reference channel for the difference calculation.

You cannot specify an AO channel.

▶ See page 2-27 in section , “Reference Channel”.

Scale*

Setup Item	Selectable Range or Options	Default Value
Decimal place	0/1/2/3/4/5	2
Lower	-999999 to 999999	0.00
Upper	-999999 to 999999	100.00
Unit	Character string (up to 6 characters, <input)<="" td="" type="text" value="Aa#1"/> <td>—</td>	—

* You can set this when Calculation is set to **Linear scaling**.

▶ See page 2-28 in section , “Scale*”.

Moving Average

Setup Item	Selectable Range or Options	Default Value
On/Off	Off, On	Off
Count*	2 to 100	2

* You can set this when On/Off is set to **On**.

▶ See page 2-29 in section , “Moving Average”.

Note

- If you change the GM’s time or when the time is being gradually adjusted, the scan interval will change. This will change the measured values of each scan interval, but it will not affect the integration result (TLOG.PSUM).
- The default span upper and span lower limits assume values that are affected the most by a time change at the scan interval of 5 s.

2.5.2 Setting Alarms

Path

Web application: **Config**. tab > **Pulse input channel settings** > **Channel range** (display example: 0501-0510) > **Alarm**

Hardware configurator: **DI channel settings** > Channel range (display example: 0501-0510) > **Alarm**

Description**Level 1, Level 2, Level 3, Level 4**

Setup Item	Selectable Range or Options	Default Value
On/Off	Off, On	Off
Type ¹	H: High limit, L: Low limit, R: High limit on rate-of-change, r: Low limit on rate-of-change, T: Delay high limit, t: Delay low limit, h: Difference high limit, ² l: Difference low limit ² , F: Profile high limit ⁵ , F: Profile high limit ⁵	Off
Value ^{1,6}	Within the setting range	0
Hysteresis ^{1,4,6}	Numeric value When Calculation is set to Off or Delta: 0 to 5% of range setting When math is set to Linear scaling: 0 to 100000	0
Logging ¹	Off, On	On
Output type ¹	Off, Relay, Internal switch	Off
Output No. ³	DO channel or internal switch number	—

- 1 You can set this when Level (1 to 4) is set to **On**.
- 2 You can set this when Calculation of the range setting is set to **Delta**.
- 3 You can set this when Output type is not set to **Off**.
- 4 You can set this when the type is set to high limit, low limit, difference high limit, or difference low limit.
- 5 Release number 5 and later. The communication channel function (/MC option) is included and the profile trend setting can be configured when **On**.
- 6 You cannot set this when the type is set to profile high limit or profile low limit.

On/Off

To use an alarm level (1 to 4), set this to **On**.

Type

Set the alarm type.

► For details, see page 2-32 in section 2.3.2, “Setting Alarms”.

Alarms of channels set to difference calculation are set in the position shown in the figure below.

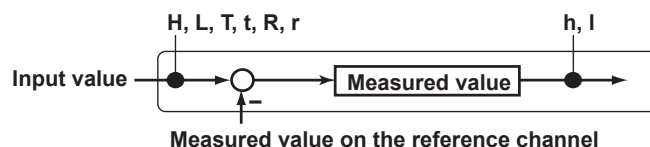
**Value**

Set the alarm value for the specified alarm type.

► For details, see page 2-32 in section 2.3.2, “Setting Alarms”.

Hysteresis

Set this to establish an offset between the value used to activate and release alarms.

Logging

Set this **On** to display an alarm (notify you) when an alarm occurs. If set to **Off**, when an alarm occurs, the GM outputs signals to alarm output DO channels or internal switches but does not display the alarm. Alarms are also not recorded in the alarm summary.

Output type

Set the alarm output destination.

Output No.

Set the number of the DO channel or internal switch to output alarms to.

Profile channel (Release number 5 and later) *

Setup Item	Selectable Range or Options	Default Value
High limit	Off, Communication channel	Off
Reference	Same as High limit	Off
Low limit	Same as High limit	Off

* You can set this when the communication channel function (/MC option) is included.

High limit

Sets the communication channel through which the high limit data of the profile trend is loaded.

Reference

Sets the communication channel through which the reference data of the profile trend is loaded.

Lower limit

Set the communication channel through which the low limit data of the profile trend is loaded.

Note

- You must load the profile trend in advance to read the trend data.
- Set the profile channel to the same channel as the channel number of the loaded profile trend.
- You can only set this when On/Off is set to the On communication channel.

Alarm delay (for delay high/low limit alarms) *

Setup Item	Selectable Range or Options	Default Value
Hour	1 to 24	0
Minute	0 to 59	0
Second	0 to 59	10

* You can set this when Level 1, Level 2, Level 3, or Level 4 is On.

Hour, Minute, and Second

Set the alarm delay. These values are valid when the delay high limit or delay low limit alarm is in use.

2.5.3 Setting the Display

Path

Web application: **Config.** tab > **Pulse input channel settings** > **Channel range** (display example: 0501-0510) > **Display settings**

Hardware configurator: **Pulse input channel settings** > Channel range (display example: 0501-0510) > **Display settings**

Description

Tag

Setup Item	Selectable Range or Options	Default Value
Characters	Character string (up to 32 characters, <input)<="" td="" type="text" value="Aa#1"/> <td>—</td>	—
No.	Character string (up to 16 characters, <input)<="" td="" type="text" value="Aa#1"/> <td>—</td>	—

Characters

Set the tag.

Not all characters may be displayed due to space constraints.

No.

Set the tag number.

Color

Setup Item	Selectable Range or Options	Default Value
Color	24 colors (red, green, blue, blue violet, brown, orange, yellow-green, light blue, violet, gray, lime, cyan, dark blue, yellow, light gray, purple, black, pink, light brown, light green, dark gray, olive, dark cyan, and spring green) and a user-defined color (1 color)	—

Color

Set channel display colors. The colors apply to the trend display and bar graph display.

► For instructions on how to set the user-defined color, see page 2-13 in section , “Operation Example 2”.

Zone

Setup Item	Selectable Range or Options	Default Value
Lower	0 to 95%	0
Upper	5 to 100%	100

Lower and Upper

Set these values when you want to divide the waveform displays of channels into separate zones so that waveforms do not overlap. Set the **Lower** and **Upper** positions as percentages of the maximum display width. Set **Lower** to a value less than **Upper**, and set the zone width (**Upper – Lower**) to be 5% or greater.

Bar graph

Setup Item	Selectable Range or Options	Default Value
Base position	Lower, Center, Upper	Lower

Base position

Set the bar graph base position. This setting is applied on the bar graph display.

► For display examples, see page 3-12 in section , “Trend Monitor, Digital Monitor, Bar Graph Monitor, and Horizontal Bar Graph Monitor”.

Alarm Point Mark



Setup Item	Selectable Range or Options	Default Value
Indicate on Scale	Off, On	On
Mark kind	Alarm, Fixed	Alarm
Alarm 1 color to Alarm 4 color*	24 colors (red, green, blue, blue violet, brown, orange, yellow-green, light blue, violet, gray, lime, cyan, dark blue, yellow, light gray, purple, black, pink, light brown, light green, dark gray, olive, dark cyan, and spring green) and a user-defined color (1 color)	—

* You can set this when the Mark kind is set to **Fixed**.

Indicate on Scale

Set this to **On** to display alarm point marks on the scale. Set this to **Off** to not display them. This setting is shared with the bar graph display.

Mark kind

Options	Description	Mark Shape
Alarm	Displayed normally in green. Displayed in red when an alarm occurs.	 or 
Fixed	Displayed with a fixed color.	

Alarm 1 color to Alarm 4 color

When Mark kind is set to **Fixed**, set the display colors of point marks for alarm levels 1 to 4.

Display characters of each value*

Setup Item	Selectable Range or Options	Default Value
0	Character string (up to 8 characters, <input)<="" td="" type="text" value="Aa#1"/> <td>—</td>	—
1	Character string (up to 8 characters, <input)<="" td="" type="text" value="Aa#1"/> <td>—</td>	—

* You can set this when the range set to **DI** and Calculation is set to **Off**.

0

Set the character string to display when the measured value is 0.

1

Set the character string to display when the measured value is 1.

► For usage examples, see page 2-36 in section 2.3.3, “Setting the Display”.

2.6 Configuring AO Channels (Analog input channels)

Set the analog output channels' range and display conditions.

2.6.1 Setting the Range

Path

Web application: Config. tab > AO channel settings > Channel range (display example: 0701-0704) > Range

Hardware configurator: AO channel settings > Channel range (display example: 0701-0704) > Range

Description

Range

Setup Item	Selectable Range or Options	Default Value
Type	Skip, Re-Trans, Manual	Skip
Range*	4-20mA/0-20mA	4-20mA
Span Lower*	4.000 to 20.000, 0.000 to 20.000	4.000
Span Upper*	4.000 to 20.000, 0.000 to 20.000	20.000

* You cannot set this when Type is set to Skip.

Type

Set the output type.

Option	Description
Skip	Nothing is output.
Retransmission output	An analog value corresponding to the span of the specified reference channel is output.
Manual output	A specified value is output.

Range

Set the output range.

Span Lower, Span Upper

Set the output span. You cannot set the same value to Span Lower and Span Upper.

Reference channel*

Setup Item	Selectable Range or Options	Default Value
Channel type	Input channel, Math channel, Communication channel	Input channel
Channel number	Number (reference channel number)	—

* You can set this when the range type is set to Re-Trans.

Channel type

Set the reference channel type for retransmission output.

Channel number

Set the reference channel number for retransmission output.

Preset value

Setup Item	Selectable Range or Options	Default Value
Preset value	0.000 to 22.000	0.000

Preset value

Set the preset value when Preset action is set to Preset value.
 The preset value is independent of the span setting. It can be set to any value within the setting range.

Preset action

Setup Item	Selectable Range or Options	Default Value
At power-on	Preset value, Last value	Preset value
On error	Preset value, Last value	Preset value
Re-trans stop	Preset value, Last value	Preset value

At power-on

Zero is output while initialization is in progress at power on.
 After initialization, the previous value or preset value is output until the first output is determined (while measurement is being started).

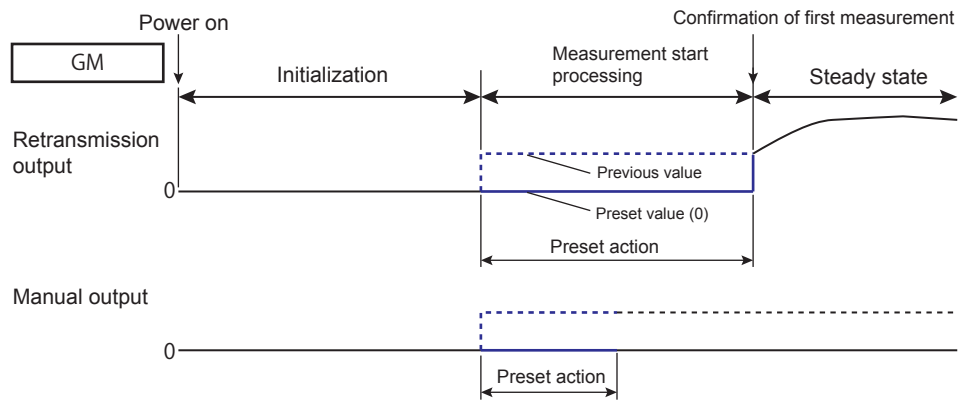

On error

If the main unit fails or the connection to the expandable I/O is disconnected, the previous value or preset value is output.

Even when the reference channel cannot be measured, the previous value or preset value is output. See the following explanation.

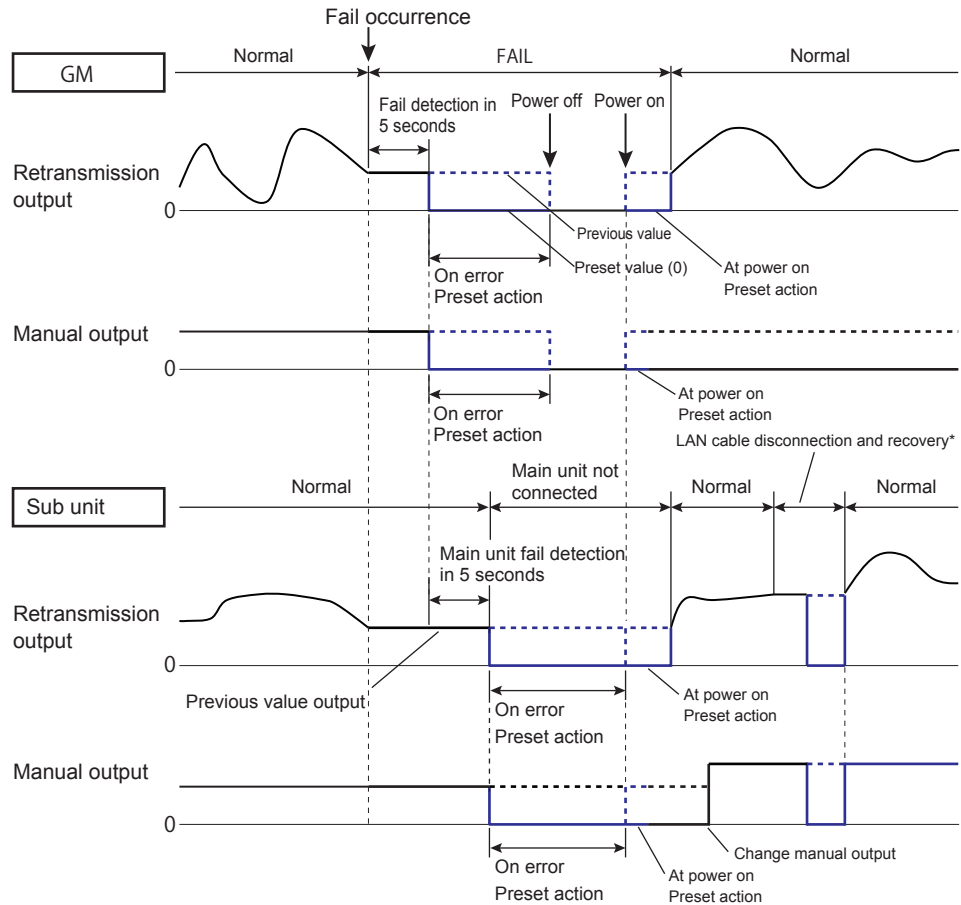

* When the LAN cable is disconnected, the previous value is output for 5 seconds. When 5 seconds elapse, preset action on error is performed. If the connection recovers, the output is resumed.

Re-trans stop

The previous value or preset value is output when the range type is set to retransmission output in the following situations. This does not work when the range type is set to manual output.

- When computation is stopped if the reference channel is a math channel
- When retransmission output is off

Description

Retransmission Output Operation

- If the output value is outside +105% to -5% of the reference channel's set span, the output is clipped at the boundaries of this span. (If the output value is outside the 0 to 22 mA range, the output is clipped at the boundaries of this range.)
- If the reference channel is a measurement channel or communication channel, when the reference channel is +OVER, the output is clipped at 105% of the output channel's set span. When the reference channel is -OVER, the output is clipped at -5% of the set span.

Preset action

When the reference channel is a measurement channel

State	Preset action
When retransmission output is off	Preset action when stopped
When the module has been removed, measurement channel is set to Skip, A/D error, calibration error, burnout	Preset action on error

When the reference channel is a communication channel

State	Preset action
When retransmission output is off	Preset action when stopped
When NaN is input, communication channel is off	Preset action on error

When the reference channel is a math channel

State	Preset action
When math is stopped	Preset action when stopped
When retransmission output is off	
When the math channel value is +OVER, -OVER, math error, or when the math channel is off	Preset action on error

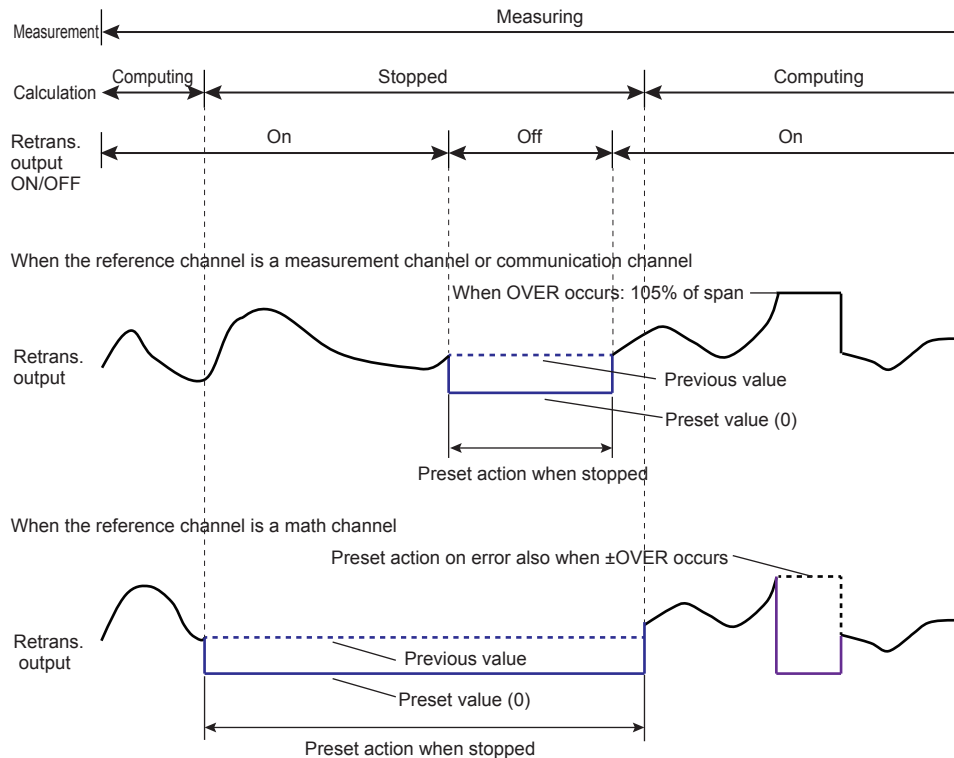

Output Action When Settings Are Changed

Retransmission output

Description of change	Action
<ul style="list-style-type: none"> Reference channel settings, scan interval, module operation mode, A/D integration time, over-range detection, range-over judgment upper and lower limits, chattering filter for pulse input (DI module), and temperature unit * Depending on the type of setting, it may take some time for the measurement to start after changing the setting. 	After the settings are changed, the values before the change are used until the next measurement starts. Then, the new settings are applied.
<ul style="list-style-type: none"> Output channel span 	It is applied to the next measurement after the setting has been changed.
<ul style="list-style-type: none"> Change to manual output 	The value immediately before the setting was changed is held until the next time the manual value is changed.

Manual output

Description of change	Action
<ul style="list-style-type: none"> Change to retransmission output 	It is applied to the next measurement after the setting has been changed.
<ul style="list-style-type: none"> Preset value during preset output 	It is applied at the next output update interval (100 ms).

2.6.2 Setting the display

Path

Web application: Config. tab > AO channel settings > Channel range (display example: 0701-0704) > Display settings

Hardware configurator: AO channel settings > Channel range (display example: 0701-0704) > Display settings

Description

Tag

Setup Item	Selectable Range or Options	Default Value
Characters	Character string (up to 32 characters, Aa#1)	—
No.	Character string (up to 16 characters, Aa#1)	—

Characters

Set the tag.

Not all characters may be displayed due to space constraints.

No.

Set the tag number.

Color

Setup Item	Selectable Range or Options	Default Value
Color	24 colors (red, green, blue, blue violet, brown, — orange, yellow-green, light blue, violet, gray, lime, cyan, dark blue, yellow, light gray, purple, black, pink, light brown, light green, dark gray, olive, dark cyan, and spring green) and a user-defined color (1 color)	

Color

Set channel display colors. The colors apply to the trend display and bar graph display.

- For instructions on how to set the user-defined color, see “Operation example 2” under “Editing Settings” in page 2-10 in section 2.1.6, “Change settings”.

Zone

Setup Item	Selectable Range or Options	Default Value
Lower	0 to 95%	0
Upper	5 to 100%	100

Lower and Upper

Set these values when you want to divide the waveform displays of channels into separate zones so that waveforms do not overlap. Set the Lower and Upper positions as percentages of the maximum display width. Set Lower to a value less than Upper, and set the zone width (Upper – Lower) to be 5% or greater.

Bar graph

Setup Item	Selectable Range or Options	Default Value
Base position	Lower, Center, Upper	Lower

Base position

Set the bar graph base position.

- For display examples, see the bar graph settings on page 2-36 in section 2.3.3, “Setting the Display”.

2.7 Configuring DO Channels (Digital output channels)

Set the input range and display conditions of DO channels (including the DO channels of DI/DO modules). In addition to alarm output, DO output is possible through touch operation (manual operation).

2.7.1 Setting the Range

Path

Web application: **Config.** tab > **DO channel settings*** > Channel range (display example: 0701-0706) > **Range**

Hardware configurator: **DO channel settings** > Channel range (display example: 0701-0706) > **Range**

Description

Range

Setup Item	Selectable Range or Options	Default Value
Type	Alarm, Manual, Fail	Alarm
Span Lower	0/1	0
Span Upper	0/1	1
Unit	Character string (up to 6 characters, Aa#1)	—

Type

Set the input type.

To output through touch operation (manual operation), “Changing each value from monitoring” must be set to On. ► See page 2-97 in section 2.11.5, “Turning the Operation from the Monitor Displays On and Off”.

Options	Description
Alarm	Alarm output
Manual	Manual output and event action output
Fail	Output to a DO channel of a DO module or DI/DO module when an error occurs in the GM10 CPU.

If the type is set to Fail, the GM outputs to a DO channel under the following conditions. The output information varies depending on whether the DO channel being output to is on the main unit or a sub unit.

Unit Containing the DO channel	Output Information
Main unit	When the system crashes or when a GM10 CPU error occurs
Sub unit	When the system crashes, when a GM10 CPU error occurs, when a CPU error occurs in the expansion module of a sub unit, ¹ or when the connection between sub unit is disconnected ²

¹ Only the DO channel of the sub unit in which the CPU error occurred in its expansion module

² Only the DO channel after the sub unit that was disconnected

► For details on system crashes, see page 2-212 in section 2.29.5, “Notes on System Configuration”.

Span Lower, Span Upper

Specify 0 or 1. You cannot set the same value to Span Lower and Span Upper.

Unit

Set the unit.

Operation mode¹

Setup Item	Selectable Range or Options	Default Value
Energize or De-energize ¹	Energize, De-energize	Energize
Operation mode ²	And, Or, Reflash	Or
Hold ^{2, 3}	Hold, Nonhold	Nonhold
Relay action on ACK ⁴	Normal, Reset	Normal
Relay deactivated interval ^{2, 4}	500 ms, 1 s, 2 s	500 ms

- 1 You cannot set this when Type is set to **Fail** (fixed to De-energize).
- 2 You cannot set this when Type is set to **Manual**.
- 3 You cannot set this when Action is set to **Reflash**.
- 4 You can set this when Action is set to **Reflash**.

Energize/De-energize

Set whether to **Energize** or **De-energize** the DO output when an alarm occurs. When Type is set to Fail, Normal [De-energize] is selected, and you cannot change this.

Operation Mode

Options	Description
And	Activated when all assigned alarms are occurring simultaneously
Or	Activated when any of the specified alarms is occurring
Reflash	When multiple alarms are assigned to one alarm output relay, the GM notifies the occurrence of subsequent alarms after the relay is activated by the first alarm.

Hold

Set the DO channel output operation.

Options	Description
Hold	Holds the output relay at ON until an alarm acknowledge operation is performed.
Not held	Turns the output relay off when the alarm condition is released (returns to normal condition).

Relay action on ACK

Set what the output state of the DO channel would be after an alarm ACK operation. If Individual alarm ACK is set to On, this is set to Reset.

Options	Description
Normal	The relay is deactivated when an alarm ACK is executed. If the condition for activating the alarm output relay is met in the next 100 ms, the relay will be activated. This operation is valid only when the alarm output relay is set to Hold .
Reset	The relay is deactivated when an alarm ACK is executed. If the condition for activating the alarm output relay is met again, the relay will be activated.

Example:

An example of the relay action when alarm ACK is executed is shown below. In this example, the relay is set to Or and Hold.

Normal

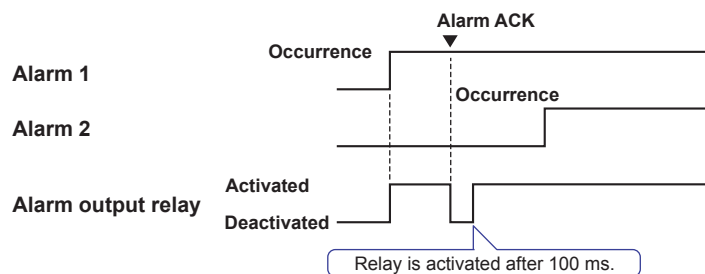

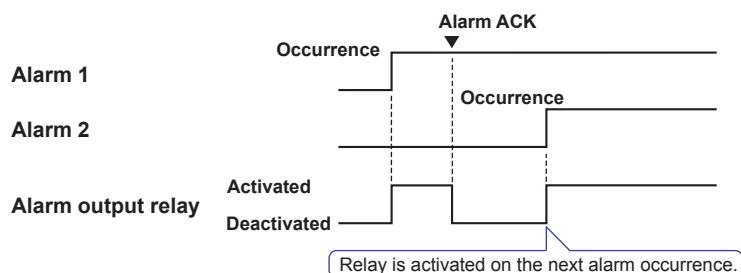
Reset**Relay deactivated interval**

Set the relay's not-active interval for reflash operation.

Explanation**AND/OR Operation**

When multiple alarms are assigned to one alarm output relay, you can select which condition below will activate the output relay. You can also specify AND operation for internal switches.

- AND: Activated when all assigned alarms are occurring simultaneously
- OR: Activated when any of the specified alarms is occurring

Reflash

When multiple alarms are assigned to one alarm output relay, this function notifies the occurrence of subsequent alarms after the relay is activated by the first alarm. When subsequent alarms occur, the output relay is released temporarily. The duration for which the relays are deactivated can be set to 500 ms, 1 s, or 2 s.

Relays set to Reflash will operate using **Or** and **Nonhold** settings.

Energize or De-energize Operation

You can select whether the alarm output relay is energized or de-energized when an alarm occurs. If you select de-energize, the alarm output relays will be in the same state when the GM is shut down as they are when an alarm occurs.

Non-hold/Hold

The alarm output relay can be set to operate in the following fashion when the alarm condition is no longer met.

- Turn OFF the relay output (nonhold).
- Hold the relay at ON until the alarm ACK is executed (hold).

Alarm ACK Operation**Acknowledging All Alarms**

The alarm acknowledge (alarm ACK) operation releases all alarm indications and relay outputs.

Acknowledging Individual Alarms

Individual alarm ACK operation releases specific alarms.

For the behavior of alarm indication and alarm output relay when you execute an alarm ACK operation, see the next page.

DO Output Relay Operation

The DO output relay operation is shown below.

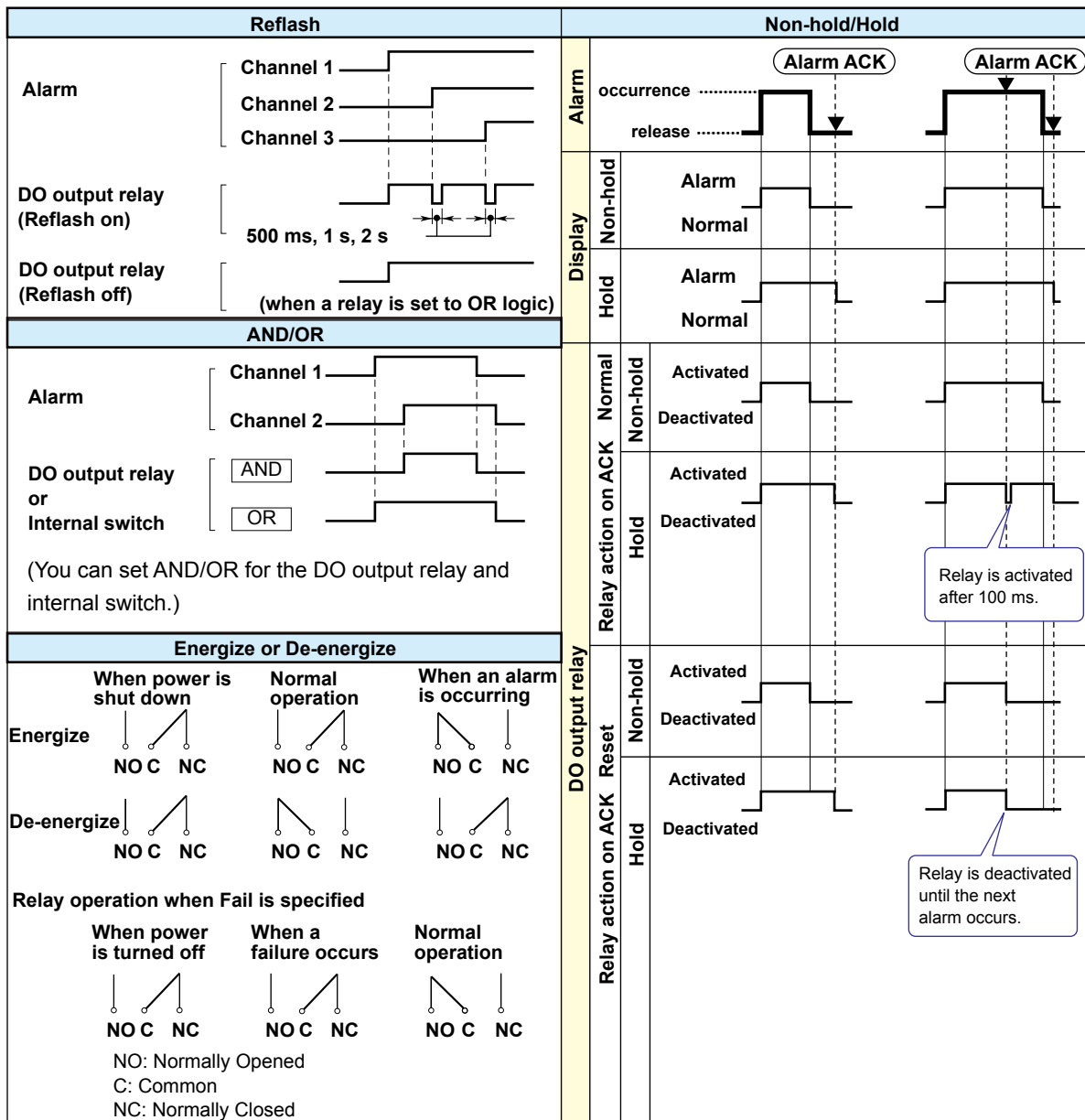

DO Output Relay Operation during an Error

When an error (FAIL) occurs in the system, the DO output relay is de-energized.

When an error occurs, the DO output relay is de-energized in the following manner.

When the system crashes	The DO output relay of the main unit is de-energized. The DO output relays of all sub units are de-energized.
When a CPU error occurs in a data acquisition module	The DO output relay of the main unit is de-energized. The DO output relays of all sub units are de-energized.
When a CPU error occurs in an expansion module	The DO output relay of the main unit continues normal operation. The DO output relays of sub units in which the error did not occur continue normal operation. The DO output relay of the sub unit in which the error occurred is de-energized.
When a connection between expandable I/Os are disconnected	The DO output relay of the main unit continues normal operation. The DO output relays of the sub unit that was disconnected and those of subsequent units are de-energized. Normal operation resumes when the connection recovers.

2.7.2 Setting the Display

Path

Web application: **Config.** tab > **DO channel settings** > Channel range (display example: 0701-0706) > **Display settings**

Hardware configurator: **DO channel settings** > Channel range (display example: 0701-0706) > **Display settings**

Description

Tag

Setup Item	Selectable Range or Options	Default Value
Characters	Character string (up to 32 characters, <input)<="" td="" type="text" value="Aa#1"/> <td>—</td>	—
No.	Character string (up to 16 characters, <input)<="" td="" type="text" value="Aa#1"/> <td>—</td>	—

Characters

Set the tag.

Not all characters may be displayed due to space constraints.

No.

Set the tag number.

Color

Setup Item	Selectable Range or Options	Default Value
Color	24 colors (red, green, blue, blue violet, brown, orange, yellow-green, light blue, violet, gray, lime, cyan, dark blue, yellow, light gray, purple, black, pink, light brown, light green, dark gray, olive, dark cyan, and spring green) and a user-defined color (1 color)	—

Color

Set channel display colors. The colors apply to the trend display and bar graph display.

► For instructions on how to set the user-defined color, see “Operation Example 2” on page 2-13.

Zone

Setup Item	Selectable Range or Options	Default Value
Lower	0 to 95%	0
Upper	5 to 100 %	100

Lower and Upper

Set these values when you want to divide the waveform displays of channels into separate zones so that waveforms do not overlap. Set the **Lower** and **Upper** positions as percentages of the maximum display width. Set **Lower** to a value less than **Upper**, and set the zone width (**Upper – Lower**) to be 5% or greater.

Bar graph base position

Setup Item	Selectable Range or Options	Default Value
Bar graph base position	Lower, Center, Upper	Lower

Bar graph base position

Set the bar graph base position. This setting is applied on the bar graph display.

- For display examples, see the bar graph settings on page 2-36 in section 2.3.3, “Setting the Display”.

Display characters of each value

Setup Item	Selectable Range or Options	Default Value
0	Character string (up to 8 characters, Aa#1)	—
1	Character string (up to 8 characters, Aa#1)	—

0

Set the character string to display when the measured value is 0.

1

Set the character string to display when the measured value is 1.

- For usage examples, see page 2-36 in section 2.3.3, “Setting the Display”.

2.8 Configuring the Control Function and Program Function (/PG option) (Release number 4 and later)

- ▶ For details on configuring the control function and protection function, see the *Loop Control Function, Program Control Function (/PG Option) User's Manual* (IM 04L51B01-31EN).
- ▶ For details on how to set program patterns, see the *SMARTDAC+ STANDARD Hardware Configurator User's Manual* (IM 04L61B01-02EN).

2.9 Configuring Math Channels (/MT option)

Configure math channels. You can define expressions using measured data and computed data as variables, compute expressions, and display and save the results.

When the measurement mode is set to High speed or Dual interval, there is a limit to the number of math channels at scan intervals shorter than 100 ms.

► For limitations, see the *GM Data Acquisition System General Specifications (GS 04L55B01-01EN)*.

2.9.1 Setting Basic Computation Operations (Error indications, operation at start, overflow handling, PSUM overflow* handling)

* Release number 3 and later

Path

Web application: **Config**. tab > **Math channel settings** > **Math action settings**

Hardware configurator: **Math channel settings** > **Math action settings**

Description

Setup Item	Selectable Range or Options	Default Value
Value on Error	+Over, -Over	+Over
START key (3s) action	Off, Start, Reset + Start	Start
STOP key (3s) action	Off, Stop	Off

Value on Error

Set how to display computation errors.

START key (3s) action, STOP key (3s) action

Set how the GM operates when the START key or STOP key is held down for 3 seconds or longer.

Options	Description
Off	Computation does not start or stop even when the START/STOP key is held down.
Start	Computation starts when the START key is held down.
Reset + Start	Computation starts when the START key is held down. If computation is already in progress, it is reset.
Stop	Computation stops when the STOP key is held down.

Value on Overflow

Setup Item	Selectable Range or Options	Default Value
SUM, AVE	Error, Skip, Limit	Skip
MAX, MIN, P-P	Over, Skip	Over

SUM, AVE

Set how to handle overflow data when it is detected in the SUM or AVE computation of TLOG or CLOG. This setting is also applied to report generation and rolling average.

Options	Description
Error	Sets the computation result to computation error.
Skip	Discards overflow data and continues the computation.
Limit	Replaces overflow data with the limit value and continues the computation.

MAX, MIN, P-P

Set how to handle overflow data when it is detected in the MAX, MIN, or P-P computation of TLOG or CLOG. This setting is also applied to report generation.

Options	Description
Over	Computes by using the overflow data.
Skip	Discards overflow data and continues the computation.

PSUM overflow handling

Setup Item	Selectable Range or Options	Default Value
Over/Rotate	Rotate, Over	Rotate

Over/Rotate

Set the handling of instances when the pulse integration result exceeds the displayable range of the math channel.

Options	Description
Over	Minimum value: -9999999 When the value falls below the minimum value, set the result to overflow and stop the computation. (Computed result: -OVER)
	Maximum value: 99999999 When the value falls below the minimum value, set the result to overflow and stop the computation. (Computed result: +OVER)
Rotate	Minimum value: 0 When the value falls below the minimum value, continue the computation by assuming the value of the next count to be the maximum value.
	Maximum value: 99999999 When the value exceeds the maximum value, continue the computation by assuming the value of the next count to be the minimum value.

2.9.2 Setting Expressions

Math Channel Range

GM10-1: A001 to A100

GM10-2: A001 to A200*

* Release number 3 and later

Path

Web application: **Config**. tab > **Math channel settings** > **Channel range** (display example: A001-A020) > **Calculation expression**

Hardware configurator: **Math channel settings** > **Channel range** (display example: A001-A020) > **Calculation expression**

Description

Math range

Setup Item	Selectable Range or Options	Default Value
On/Off	Off/On	Off
Calculation expression*	Character string (up to 120 characters)	0001
Decimal place*	0/1/2/3/4/5	2
Span Lower*	-9999999 to 99999999	0.00
Span Upper*	-9999999 to 99999999	100.00
Unit*	Character string (up to 6 characters, Aa#1)	—

* You can set this when On/Off is set to **On**.

On/Off

Set the channels that you want to use to **On**.

Computation is performed every scan interval, starting with the smallest channel number.

Example: If you specify A002=A001+A003, the value of the previous scan interval is used for A003.

Calculation expression

Set the expression.

In computations, measured values are handled as values without units. For example, if the measured data from channel 0001 is 20 mV and the measured data from channel 0002 is 20 V, the computed result of 0001 + 0002 is 40.

Note

Not all characters may be displayed due to space constraints.

2.9 Configuring Math Channels (/MT option)

Data That Can Be Used in Expressions

You can use the data shown below in expressions.

Data	Notation	Description
I/O channel data	0001 or the like	Specify channel numbers.
Math channel data ¹	A001 or the like	Specify channel numbers.
Constant	K001 to K100	Values.
Variable constant ⁴	W001 to W100	Values.
Integer data ⁴	Z000 to Z999	Integers.
Logic math data ^{4, 5}	LM01 to LM50	Specify with a logic math number.
Communication channel data ²	GM10-1: C001 to C300 GM10-2: C001 to C500	Specify communication channel numbers.
Communication channel raw data ² (release number 3 and later)	GM10-1: RC001 to RC300 GM10-2: RC001 to RC500	Specify communication channel numbers (see "Handling of Math Channel Data (Difference between Cxxx and RCxxx)").
Internal switch status	S001 to S100	1 or 0.
Flag	F01 to F20	1 or 0. Use the event action function to set the flag (for details, see page 2-135 in section 2.20, "Configuring the Event Action Function").
Recording status	GM10-1: REC01 to REC06 ³ GM10-2: REC01 to REC12 ³	Recording (1), not recording (0). If the multi-batch function (release number 3 and later, /BT option) is not in use, "REC01" shows the recording (memory sampling) status. If the multi-batch function is in use, "REC01" to "REC12" show the recording (memory sampling) status of each batch group. Recording status of invalid batch groups is 0.

- 1 The /MT option is required.
- 2 The /MC option is required.
- 3 REC02 to REC12 are available in release number 3 and later.
- 4 Release number 4 and later
- 5 Can be used only for logic math.

Only the types of data with ✓ marks in the table below can be used in TLOG, CLOG, and PRE.

Comp. Type	Data	I/O channel	Math channel	Communication channel	Constant/ Variable constant	Internal switch	Flag	Recording status	Integer data
TLOG		✓	✓	✓	✓				
TLOG.PSUM		✓*							
CLOG		✓	✓	✓					
PRE		✓	✓	✓	✓				
Other computations		✓	✓	✓	✓	✓	✓	✓	✓

Bad examples: TLOG.SUM(S01), CLOG.AVE(0001.0002.K01), PRE(S01)

* GX90XP pulse input module only

Decimal Place

Set the decimal place for span lower and span upper.

Span Lower, Span Upper

Set the measurement range.

The decimal place is determined by the **Decimal place** setting.

Unit

Set the unit of computed values.

TLOG

Setup Item	Selectable Range or Options	Default Value
Timer type	Timer, Match Time Timer	Timer
Timer No.	1, 2, 3, 4, 5, 6, 7, 8, 9, 10, 11, 12*	1
Sum scale	Off, sec, min, hour	Off
Reset	Off, On	Off

* Release number 3 and later

Timer type

Set the timer type.

Timer No.

Set the number of the timer that you want to use.

Sum scale

Set the sum scale depending on the unit of measured values.

Set the sum scale when using sum computation (TLOG.SUM).

Example: If the unit of the measured value is "m³/min," select **min**.

If you select Off, the measured data is summed as-is once per scan interval.

Reset

To reset the TLOG computed value at each interval, select **On**.

The figure below illustrates the reset operation of sum computation (TLOG.SUM).

Example: Result of the TLOG.SUM computation

When reset is **On**, the sum value is computed over each interval. When set to **Off**, the sum value from computation start is computed.

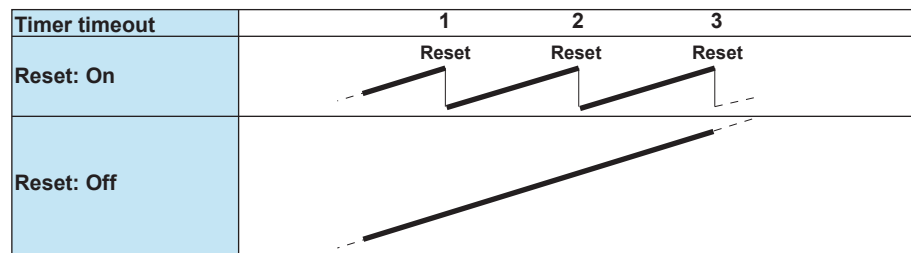

Rolling average

Setup Item	Selectable Range or Options	Default Value
On/Off	Off, On	Off
Interval*	1s, 2s, 3s, 4s, 5s, 6s, 10s, 12s, 15s, 20s, 30s, 1min, 2min, 3min, 4min, 5min, 6in, 10min, 12min, 15min, 20min, 30min, 1h	10s
Number of samples*	1 to 1500	1

* You can set this when rolling average is **On**.

On/Off

Set this to **On** to perform rolling average.

Interval

Set the sampling interval for performing rolling average. The sampling interval takes on a value that is an integer multiple of the scan interval. For example, if the sampling interval is set to 5 s when the scan interval is 2 s, the actual sampling interval is 6 s.

Number of samples

Set the number of samples for performing rolling average.

The rolling average time is equal to the sampling interval × the number of samples.

Note

- If the number of data points to be averaged has not reached the specified number of samples immediately after computation is started, the average of the available data is computed.
 - Computation error data is excluded from the rolling average computation.
 - If the computed data goes outside the upper and lower limits, the data is handled according to the Value on Overflow setting.
 - If set to Error or Skip, the computed data is not used in the rolling average.
 - If set to Limit, the computed data is clipped at the limit value, and the rolling average is computed.
- The limits are “±100000000” ignoring the decimal point. The decimal place is the same as that of the span lower limit.

Explanation

TLOG Computation

TLOG computation determines the sum, maximum, minimum, average, or the difference between the maximum and minimum of a specific channel for each interval determined by a timer.

Computation Data Dropout

A computation data dropout occurs if the computation is not completed within the scan interval.

- When a computation data dropout occurs, the computed data of the scan interval in which the dropout occurred is set to the data immediately before the dropout.
- If computation data dropout occurs frequently, reduce the load on the CPU by reducing the number of math channels or setting a longer scan interval.
- In report computation (integration, average) and TLOG (SUM, AVE), the most recent value is summed for the number of computation data dropout occurrences.
- In pulse integration (TLOG.PSUM), integration is performed without being affected by computation data dropouts.

Numeric Display and Recording

The range of displayed values of computed data is from -9999999 to 99999999 excluding the decimal point. The decimal place corresponds to the decimal place of the lower limit span of the math channel. On the numeric display, values are displayed if the computed result is within the above range regardless of the upper and lower limits of span. The following table indicates special displays.

Display/Recording	Computed Data Status
+Over	<ul style="list-style-type: none"> • +Display over: When a computed result exceeds 99999999 • +Computation over: When a value exceeds approximately 1.79E+308 in the middle of the computation • When a computation error* occurs (you can select +Over or -Over.)
-Over	<ul style="list-style-type: none"> • -Display over: When a computed result is less than -9999999 • -Computation over: When a value is less than approximately -1.79E+308 in the middle of the computation • When a computation error* occurs (you can select +Over or -Over.)

- * Computation error occurs when the following computation is carried out.
 - /0, SQR(-X), or LOG(-X)
 - If a channel number set to skip or Off is used in the equation
 - If error data is used in the equation

Special Data Processing

This section explains the handling of special data in TLOG computation, CLOG computation, and reports.

Power Failure Operation (TLOG and Reports)

If a power failure occurs when the report function is enabled or in the middle of the TLOG computation, the report operation and TLOG computation resume when the GM recovers from the power failure. The operation varies depending on whether the GM recovers from the power failure before or after the time to create a report or the TLOG interval timeout.

Time of Recovery	Operation
After the time to create the data	The report data is created immediately after the GM recovers. The measured data up to when the power failure occurred is used to create the report. When the time to create the next report data arrives, the data after the recovery is used. The interval timer for TLOG data expires immediately after the GM recovers.
Before the time to create the data	After the GM recovers, report data is created at the normal time to create the data. The measured data excluding the power failure period is used to create the report. The interval timer for TLOG data expires after the GM recovers.

Error Data Handling (TLOG, CLOG, and Reports)

If an error occurs in the channel data, the error data is discarded, and the computation continues.

If all the data are in error, an error results.

The following types of data are considered error data.

- Channels set to skip or Off.
- The measured result on an I/O channel is error (A/D converter failure, etc.).
- I/O channel input is in a burnout condition.
- The computed result on a math channel is error.

Handling of Overflow Data*

- * Refers to over range on an I/O channel, computation overflow on a math channel, and over range on a communication channel.

For TLOG, CLOG, and Reports

When the channel data is overflow data, the GM handles it as follows:

Computation Type	Description
Average value or sum value	Set the handling to Error, Skip, or Limit. Error: Sets the computation result to computation error. Skip: Discards overflow data and continues the computation. Limit: Replaces overflow data with the limit value and continues the computation. Limit value: Measurement channels: Upper or lower limit of the selectable range or the scale upper or lower limit Math channels, communication channels: Span upper or lower limit
Maximum, minimum, Maximum – minimum	Set the handling to Over or Skip. Over: Computes by using the overflow data. Skip: Discards overflow data and continues the computation.

For Multiplication and Relation Computation EQ and NE

Computation Type	Computation	Computed Result
Multiplication	0*(+Over)	0
	0*(-Over)	0
	(+Over)*0	0
	(-Over)*0	0
.EQ.	(+Over).EQ.(+Over)	0
	(-Over).EQ.(-Over)	0
.NE.	(+Over).NE.(+Over)	1
	(-Over).NE.(-Over)	1

Handling of Math Channel Data (Difference between Cxxx and RCxxx)

The differences in how computation on communication channels is handled are explained below.

- Cxxx uses the measured results of communication input from a PC or the like (display values of communication channel) in computation.
- RCxxx uses communication input from a PC or the like (display values of communication channel) directly in computation.

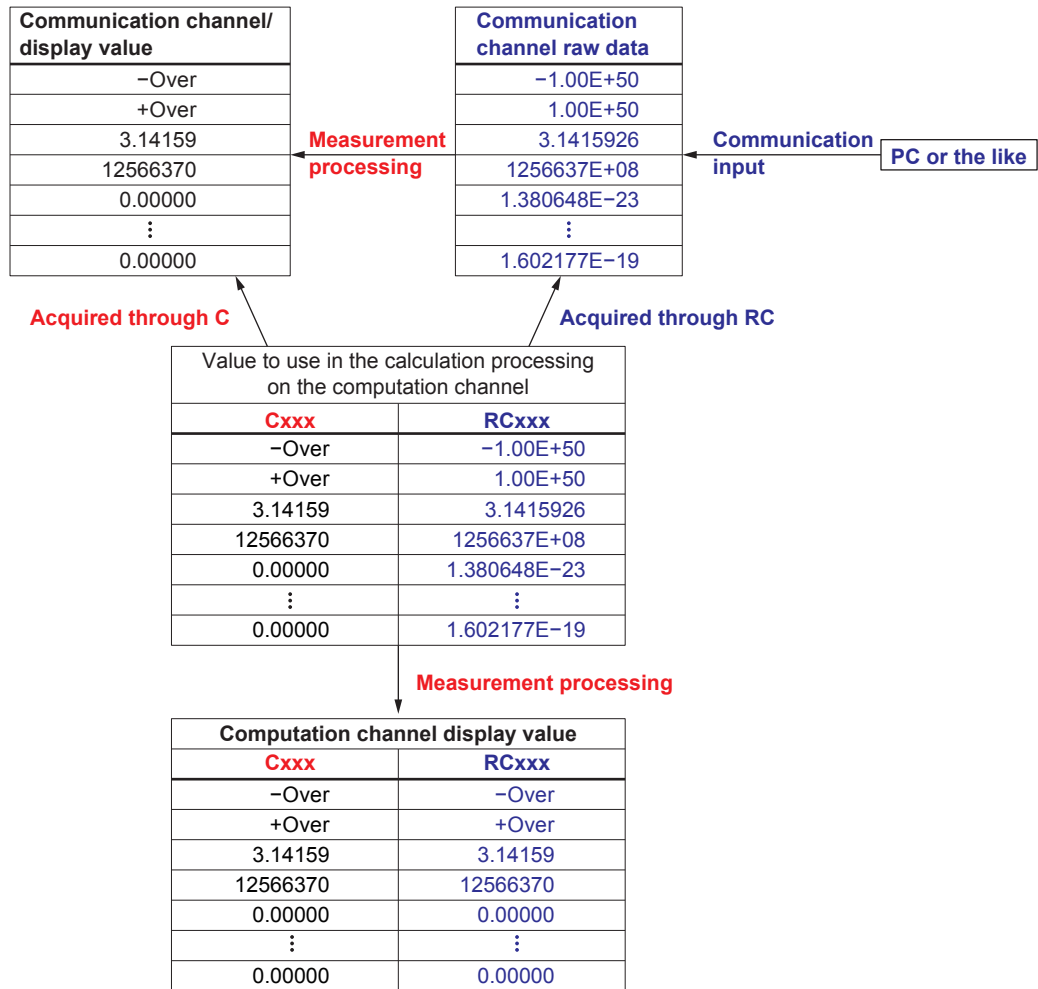

Computational Processing When the Measurement Mode Is Set to Dual interval

- Computational is performed at the scan interval of the measurement group set with the master scan interval. If a channel in a measurement group using a scan interval different from the master scan interval is used, it is indefinite as to which measured value of this channel in time will be used for the difference calculation.
- Pulse integration (TLOG.PSUM) is performed only when the measured value of the channel used in the calculation expression is updated. However, computation is performed at the master scan interval.

Computational Processing When the Measurement Mode Is Set to High Speed

Computation is performed at the scan interval, but computational processing is performed at 100 ms.

2.9.3 Writing Expressions

Common Items

Follow the rules below when writing expressions.

- Use up to 120 characters to write expressions.
- The precedence of computing terms can be specified using parentheses.
- Specify channels in expressions using channel numbers.
Example: 0001, 0012, A001, C001
- The "0" in the top digit of I/O channel numbers (0101), math channel numbers (A001), communication channel numbers (C010), constants (K), internal switch numbers (S), flags (F), variable constants (W), integer data (Z), and recording status (REC) can be omitted.
Examples: 101, A1, C10, K1, S1, F1, REC1, W1, Z1
- The data of the previous scan is used in the computation for its own channel number and channel numbers greater than its own channel number in the expression.
- Write special computations (HOLD, RESET, and CARRY) and conditional expressions at the beginning of expressions.

Order of Precedence in Computations

The order of precedence of computation in expressions is as follows:

Type	Computing Element
Function	ABS(), SQR(), LOG(), LN(), EXP(), TLOG.MAX(), TLOG.MIN(), TLOG.AVE(), TLOG.SUM(), TLOG.P-P(), TLOG.PSUM(), CLOG.MAX(), CLOG.MIN(), CLOG.AVE(), CLOG.SUM(), CLOG.P-P(), BIT, INT, SIN, COS, CLOG.PAVE, CP.O2, CP.CO2
Special computation and conditional expression	PRE, HOLD, RESET, CARRY, [a?b:c]
Power	**
Logical negation	NOT
Multiplication and division	*, /, MOD
Addition and subtraction	+, -
Greater than and less than	.GT. (or >), .LT. (or <), .GE. (or >=), .LE. (or <=)
Equal and not equal	.EQ. (or =), .NE. (or <>)
Logical product	AND
Logical sum and exclusive logical sum	OR, XOR

Limitations

The following limitations exist in expressions.

Type	Limitation
TLOG computation	A computing element cannot be written inside the parentheses. Only one TLOG computation can be specified in a single expression.
CLOG computation	The number of channels that can be written in the parentheses is up to 30 channels. A computing element cannot be written inside the parentheses. Only one CLOG computation can be specified in a single expression.
PRE	A computing element cannot be written inside the parentheses.
HOLD(a):b	Can only be written at the beginning of an expression. Only one HOLD computation can be specified in a single expression.
RESET(a):b	Can only be written at the beginning of an expression. Only one RESET computation can be specified in a single expression.
CARRY(a):b	Can only be written at the beginning of an expression. Only one CARRY computation can be specified in a single expression. Only TLOG.SUM can be written in b.
Conditional equation [a?b:c]	RESET, CARRY, or HOLD cannot be written to a, b, or c. Other computing elements cannot be combined (example: [a?b:c]+0001) However, conditional equations can be specified for a, b, and c.

Basic Arithmetic

Expression Examples

- Addition $0001+0002$
(Determines the sum of the measured values of channels 0001 and 0002)
- Subtraction $0001-0002$
(Determines the difference of the measured values of channels 0001 and 0002)
- Multiplication $0001*K003$
(Multiplies constant K003 to the measured value of channel 0001)
- Division $0001/K002$
(Divides the measured value of channel 0001 by constant K002)

Power and Other Computations

Expression Examples

- Power $0001**0002$
(Determines the measured value of channel 0001 to the power of the measured value of channel 0002)
- Square root $SQR(0002)$
(Determines the square root of the measured value of channel 0002)
- Absolute value $ABS(0002)$
(Determines the absolute value of the measured value of channel 0002)
- Common logarithm $LOG(0001)$
(Determines the common logarithm (log10) of the measured value of channel 0001)
- Natural logarithm $LN(0001)$
(Determines the natural logarithm of the measured value of channel 0001)
- Exponent $EXP(0001)$
(Determines e to the power of the measured value of channel 0001)

Relational Computation

Expression Examples

0002.LT.0003, 0002<0003

If the measured value of channel 0002 is less than the measured value of channel 0003, the computed result is 1.

Otherwise, the result is 0.

0002.GT.0003, 0002>0003

If the measured value of channel 0002 is greater than the measured value of channel 0003, the computed result is 1.

Otherwise, the result is 0.

0002.EQ.0003, 0002=0003

If the measured value of channel 0002 is equal to the measured value of channel 0003, the computed result is 1.

Otherwise, the result is 0.

0002.NE.0003, 0002<>0003

If the measured value of channel 0002 is not equal to the measured value of channel 0003, the computed result is 1.

Otherwise, the result is 0.

0002.GE.0003, 0002>=0003

If the measured value of channel 0002 is greater than or equal to the measured value of channel 0003, the computed result is 1. Otherwise, the result is 0.

0002.LE.0003, 0002<=0003

If the measured value of channel 0002 is less than or equal to the measured value of channel 0003, the computed result is 1. Otherwise, the result is 0.

Logical Computation

Checks whether the two data values, e1 and e2 (e1 only for NOT), are zeros or non-zeros, and computes according to the conditions.

AND

Logical product

(Syntax) e1ANDe2

(Condition) If the two data values e1 and e2 are both non-zeros, the computed result is 1. Otherwise, it is 0.

(Explanation) $e1 = 0, e2 = 0 \rightarrow e1ANDe2 = 0$
 $e1 \neq 0, e2 = 0 \rightarrow e1ANDe2 = 0$
 $e1 = 0, e2 \neq 0 \rightarrow e1ANDe2 = 0$
 $e1 \neq 0, e2 \neq 0 \rightarrow e1ANDe2 = 1$

OR

Logical sum

(Syntax) e1ORe2

(Condition) If the two data values e1 and e2 are both zeros, the computed result is 0. Otherwise, it is 1.

(Explanation) $e1 = 0, e2 = 0 \rightarrow e1ORe2 = 0$
 $e1 \neq 0, e2 = 0 \rightarrow e1ORe2 = 1$
 $e1 = 0, e2 \neq 0 \rightarrow e1ORe2 = 1$
 $e1 \neq 0, e2 \neq 0 \rightarrow e1ORe2 = 1$

XOR

Exclusive OR

(Syntax) e1XORe2

(Condition) If the two data values e1 and e2 are zero and non-zero or non-zero and zero, the computed result is 1. Otherwise, it is 0.

(Explanation) $e1 = 0, e2 = 0 \rightarrow e1XORe2 = 0$
 $e1 \neq 0, e2 = 0 \rightarrow e1XORe2 = 1$
 $e1 = 0, e2 \neq 0 \rightarrow e1XORe2 = 1$
 $e1 \neq 0, e2 \neq 0 \rightarrow e1XORe2 = 0$

NOT

Logical negation

(Syntax) NOTe1

(Condition) The result is the inverse of the status of data e1 (zero or non-zero).

(Explanation) $e1 = 0 \rightarrow NOTe1 = 1$
 $e1 \neq 0 \rightarrow NOTe1 = 0$

Expression Example

0001-0002OR0003.GT.0004

Determines the OR of the computed results of "0001-0002" and "0003.GT.0004".

TLOG Computation

TLOG computation determines the sum, maximum, minimum, average, or the difference between the maximum and minimum of a specific channel for each interval determined by a timer.

In the explanation below, an expression containing a computing element, an internal switch (S), and a flag (F) cannot be written in e1. In addition, only one TLOG computation can be specified in a single computing expression.

TLOG.MAX()

Maximize

(Syntax) TLOG.MAX(e1)

(Condition) Determines the maximum value of channel e1.

TLOG.MIN()

Minimize

(Syntax) TLOG.MIN(e1)

(Condition) Determines the minimum value of channel e1.

TLOG.AVE()

Average value

(Syntax) TLOG.AVE(e1)

(Condition) Determines the average value of channel e1.

TLOG.SUM()

Sum value

(Syntax) TLOG.SUM(e1)

(Condition) Determines the sum of channel e1.*

* Only the input channels of GX90XP pulse input modules

TLOG.PSUM()

Sum value

(Syntax) TLOG.PSUM(e1)

(Condition) Determines the sum of channel e1.

TLOG.P-P()

Maximum – minimum value

(Syntax) TLOG.P-P(e1)

(Condition) Determines the maximum - minimum value of channel e1.

Expression Example

TLOG.MAX(0001)+K001*SQR(0002)

Examples of Equations That Are Not Allowed

TLOG.AVE(0001)+TLOG.AVE(0002)

Reason: TLOG appears twice in one equation.

TLOG.AVE(ABS(0001))

Reason: A computing element is used inside the parentheses.

CLOG Computation

Only data of I/O channels, math channels, and communication channels can be used in CLOG computations. Up to 30 channels can be written in the parentheses.

In the explanation below, an expression containing a computing element cannot be written to e1, etc. In addition, only one CLOG computation can be specified in a single computing expression.

CLOG.SUM()

Sum value

(Syntax) CLOG.SUM(e1.e2.e4-e6)

(Condition) Determines the sum of the data of channels e1, e2, e4, e5, and e6 that are measured at the same time.

CLOG.MAX()

Maximize

(Syntax) CLOG.MAX(e1.e2.e4-e6)

(Condition) Determines the maximum value among the data of channels e1, e2, e4, e5, and e6 that are measured at the same time.

CLOG.MIN()

Minimize

(Syntax) CLOG.MIN(e1.e2.e5.e7)

(Condition) Determines the minimum value among the data of channels e1, e2, e5, and e7 that are measured at the same time.

CLOG.AVE()

Average value

(Syntax) CLOG.AVE(e1-e6)

(Condition) Determines the average value among the data of channels e1 to e6 that are measured at the same time.

CLOG.P-P()

Maximum – minimum value

(Syntax) CLOG.P-P(e1.e2.e5.e7)

(Condition) Determines the difference between the maximum and minimum values among the data of channels e1, e2, e5, and e7 that are measured at the same time.

CLOG.PAVE() (Release number 4 and later)

Average

(Syntax) CLOG.PAVE(e1.e2.e3.e4.e5-e7)

(Condition) Determines the average value by excluding input that falls outside a given width from the pattern (SP) during program operation. For e1 to e4 only, constants and variable constants can be used.

e1: Calculation method switch flag (decimals rounded, computed as CLOG.AVE if zero)

e2: Loop number (decimals truncated)

e3: Effective width for ramp

e4: Effective width for soak

e5 to e7: Channels for calculating the average

Expression Example

CLOG.MAX(0001.0002.A004-A006)+K001*SQR(0002)

CLOG.PAVE(W001.K001.K002.K003.0207.0208)

- During periods in which measured values are unstable such as during startup, W001 is set to 0, and the average of all input values is determined. During period in which measured values are stable, W001 is set to 1, and the average is determined from the input values within the effective width.

Examples of Equations That Are Not Allowed

CLOG.AVE(0001.0003.0005)+CLOG.AVE(0002.0004.0006)

Reason: CLOG appears twice in one equation.

CLOG.AVE(001.ABS(001))

Reason: A computing element is used inside the parentheses.

Special Computations

PRE()

(Syntax) PRE(e1)

(Condition) Determines the previous value of e1.

HOLD(a):b

(Syntax) HOLD(a):b

(Condition) When a is zero, b is carried out to derive the computed value. Otherwise, the previous computed value is held.

Expression Example

Under normal conditions, TLOG.SUM(0001) is carried out to derive the computed value. When [0001] exceeds K01, the previous computed value is held.

HOLD(0001.GT.K01):TLOG.SUM(0001)

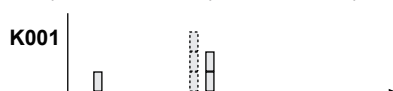

RESET(a):b

(Syntax) RESET(a):b

(Condition) When a is zero, b is carried out to derive the computed value. Otherwise, the previous computed value of b is reset, and b is carried out to derive the computed value.

Expression Example

Under normal conditions, TLOG.SUM(0001) is carried out to derive the computed value. When [A001] exceeds K01, the previous computed value is reset, and TLOG.SUM(0001) is carried out.

RESET(A001.GT.K01):TLOG.SUM(0001)

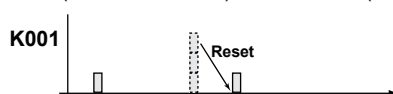

CARRY(a):b

(Syntax) CARRY(a):b

(Condition) Only TLOG.SUM can be specified for b. If the computed value X of b is less than a, the computed result is X. If X is greater than or equal to a, the computed result is the excess (X - a).

(Explanation) When a value such as the flow rate is summed and the threshold value is reached or exceeded, the sum value is reset while carrying over the amount that exceeded the threshold value.

Expression Example

Expression that sums the values of channel 0001 and resets the value when it reaches or exceeds 10000.

K001=10000

CARRY(K001):TLOG.SUM(0001)

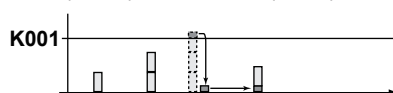

Examples of Equations That Are Not Allowed

0002+HOLD(K001):TLOG.SUM(0001)

Reason: HOLD is not at the beginning of the expression.

RESET(A001.GT.K001):TLOG.SUM(0001)+RESET(A001.GT.K001):0002

Reason: RESET appears twice in one equation.

Conditional Expression

[a?b:c]

(Syntax) [0001.GT.K001?0002:0003]

(Condition) If the measured value of channel 0001 is greater than constant K001, the computed result is the measured value of channel 0002. Otherwise, the computed result is the measured value of channel 0003.

Examples of Equations That Are Not Allowed

[0001.GT.K001?0002:0003]*K002

Reason: Used in combination with another computing element.

Nested Conditional Expressions

A conditional expression can be written to Expression1, Expression2, and Expression3 in the equation [Expression1?Expression2:Expression3]. For example, the following expression is allowed: [Equation1?[Equation2-1?Equation2-2:Equation2-3]:[Equation3-1?Equation3-2:Equation3-3]].

Expressions can be nested as long as the number of characters of the expression does not exceed 120 characters.

Bit Operation

BIT

(Syntax) BIT.Bnn (0001)

(Condition) Assuming that the channel 0001 data (positive integer) is bit data, the nth (B00 to B31) bit is output. If the target bit is 1, the computed result is 1. If the target bit is 0, the computed result is 0.

The higher digit "0" in "Bnn" cannot be omitted.

(Explanation) The status information (e.g., test information) of a lower-level device can be extracted via Modbus communication and processed using bit operation.

The result can be used in alarms, event action, and so on.

If the value includes a decimal, the value is rounded to the nearest integer before performing calculation.

If the input data is 0 or a negative number, the output value is 0.

If the input value is not a number (e.g., ±Over or error), the computed result is error. The error display varies depending on the Value on Error setting in Math action settings.

If computation is performed on a communication channel (maximum data value: 99999999), the valid bit specification is up to B26.

Example when the data value is 3 (0000 0000 0000 0000 0000 0000 0000 0011)

For B01

BIT.B01(C001) = 1

For B02

BIT.B02(C001) = 0

Integer Extraction Operation

INT

(Syntax) INT (0001)

(Condition) Determines the maximum integer that does not exceed the channel 0001 data value. If the channel 0001 data value is 123.45, the computed result is 123.

(Explanation) Operation example

When channel 0001 is 4.3

INT (0001) = 4.0

When channel 0001 is 5.5

INT (0001) = 5.0

When channel 0001 is -2.2

INT (0001) = -3.0

When channel 0001 is -3.8

INT (0001) = -4.0

Remainder Extraction Operation

MOD

- (Syntax) 0001.MOD.K001
 (Condition) Determines the remainder when channel 0001 is divided by constant K001.
 (Explanation) Operation example
 When channel 0001 is 10 and channel K001 is 3
 0001 .MOD. K001 = 1
 When channel 0001 is 7.5 and channel K001 is -2
 0001 .MOD. K001 = -0.5
 When channel 0001 is -6 and channel K001 is 2.5
 0001 .MOD. K001 = 1.5
 When channel 0001 is -8.5 and channel K001 is -4.5
 0001 .MOD. K001 = -4.0

Trigonometric Functions

SIN

- (Syntax) SIN (0001)
 (Condition) Determines the sine value assuming the channel 0001 data value to be an angle in degrees.

COS

- (Syntax) COS (0001)
 (Condition) Determines the cosine value assuming the channel 0001 data value to be an angle in degrees.

Note

If the input data to a trigonometric function is in radians, you can use the following equation to convert into degrees.

$$(\text{degrees}) [^\circ] = (\text{radians}) [\text{rad}] \times 180 / \text{Pi}$$

CP Calculation (Release number 4 and later)

CP.O2

- (Syntax) CP.O2 (e1.e2.e3)
 (Condition) e1: Furnace temperature (727.7°C to 1500.0°C)
 e2: CO partial pressure (0 vol% to 100 vol%)
 e3: Zirconia O2 sensor electromotive force (0 V to 2 V)
 (Explanation) Determines the CP value [wt%] from the zirconia O2 sensor electromotive force, CO partial pressure, and furnace temperature. If a value outside the range is input in e1 to e3, the calculated result will be 2.00000.

CP.CO2

- (Syntax) CP.CO2 (e1.e2.e3)
 (Condition) e1: Furnace temperature (727.7°C to 1500.0°C)
 e2: CO partial pressure (0 vol% to 100 vol%)
 e3: CO2 partial pressure (0 vol% to 100 vol%)
 (Explanation) Determines the CP value [wt%] from the O2 partial pressure, CO partial pressure, and furnace temperature. If a value outside the range is input in e1 to e3, the calculated result will be 2.00000.

2.9.4 Setting Alarms

Path

Web application: **Config.** tab > **Math channel settings** > **Channel range** (display example: A001-A020) > **Alarm**

Hardware configurator: **Setting** tab > **Math channel settings** > **Channel range** (display example: A001-A020) > **Alarm**

Description

Level 1, Level 2, Level 3, Level 4

Setup Item	Selectable Range or Options	Default Value
On/Off	Off, On	Off
Type ¹	H: High limit, L: Low limit, T: Delay high limit, t: Delay low limit, F: Profile high limit ⁴ , Profile low limit ⁴	H: High limit
Value ^{1,5}	-9999999 to 99999999	0.00
Hysteresis ^{1,3,5}	Numeric value (0 to 100000)	0.00
Logging ¹	Off, On	On
Output type ¹	Off, Relay, Internal switch	Off
Output No. ²	DO channel or internal switch	—

- 1 You can set this when On/Off is set to **On**.
- 2 You can set this when Output type is not set to **Off**.
- 3 You can set this when the type is set to **H:High limit** or **L:Low limit**.
- 4 Release number 5 and later. The communication channel function (/MC option) is included and the profile trend setting can be configured when **On**.
- 5 You cannot set this when the type is set to profile high limit or profile low limit.

On/Off

To use an alarm level (1 to 4), set this to **On**.

Type

Set the alarm type.

► For details, see page 2-32 in section 2.3.2, “Setting Alarms”.

Value

Set the alarm value for the specified alarm type.

Options	Value
H, L	Within -9999999 to 99999999 excluding the decimal point.
T, t	Same as H and L

Hysteresis

Set this to establish an offset between the value used to activate and release alarms.

Logging

Set this **On** to display an alarm (notify you) when an alarm occurs. If set to **Off**, when an alarm occurs, the GM outputs signals to alarm output DO channels or internal switches but does not display the alarm. Alarms are also not recorded in the alarm summary.

Output type

Set the alarm output destination type.

Output No.

Set the number of the DO channel or internal switch to output alarms to.

Profile channel (Release number 5 and later) *

Setup Item	Selectable Range or Options	Default Value
High limit	Off, Communication channel	Off
Reference	Same as High limit	Off
Low limit	Same as High limit	Off

* You can set this when the communication channel function (/MC option) is included.

High limit

Sets the communication channel through which the high limit data of the profile trend is loaded.

Reference

Sets the communication channel through which the reference data of the profile trend is loaded.

Lower limit

Set the communication channel through which the low limit data of the profile trend is loaded.

Note

- You must load the profile trend in advance to read the trend data.
- Set the profile channel to the same channel as the channel number of the loaded profile trend.
- You can only set this when On/Off is set to the On communication channel.

Alarm delay (for delay high and low limit alarms)*

Setup Item	Selectable Range or Options	Default Value
Hour	0 to 24	0
Minute	0 to 59	0
Second	0 to 59	10

* You can set this when Level 1, Level 2, Level 3, or Level 4 is On.

Hour, Minute, and Second

Set the alarm delay value. These values are valid when the delay high limit or delay low limit is in use.

2.9.5 Setting the Display

Path

Web application: **Config. tab > Math channel settings > Channel range** (display example: A001-A020) > **Display settings**
 Hardware configurator: **Math channel settings > Channel range** (display example: A001-A020) > **Display settings**

Description

Tag

Setup Item	Selectable Range or Options	Default Value
Characters	Character string (up to 32 characters, Aa#1)	—
No.	Character string (up to 16 characters, Aa#1)	—

Characters

Set the tag.
 Not all characters may be displayed due to space constraints.

No.

Set the tag number.

Color

Setup Item	Selectable Range or Options	Default Value
Color	24 colors (red, green, blue, blue violet, brown, orange, yellow-green, light blue, violet, gray, lime, cyan, dark blue, yellow, light gray, purple, black, pink, light brown, light green, dark gray, olive, dark cyan, and spring green) and a user-defined color (1 color)	—

Color

Set channel display colors. The colors apply to the trend display and bar graph display.

- ▶ For instructions on how to set the user-defined color, see “Operation Example 2” on page 2-13.

Zone

Setup Item	Selectable Range or Options	Default Value
Lower	0 to 95%	0
Upper	5 to 100 %	100

Lower and Upper

Set these values when you want to divide the waveform displays of channels into separate zones so that waveforms do not overlap. Set the **Lower** and **Upper** positions as percentages of the maximum display width. Set **Lower** to a value less than **Upper**, and set the zone width (**Upper – Lower**) to be 5% or greater.

- ▶ For display examples, see page 2-36 in section 2.3.3, “Setting the Display”.

Bar graph

Setup Item	Selectable Range or Options	Default Value
Base position	Lower, Center, Upper	Lower

Base position

Set the bar graph base position.
This setting is applied on the bar graph display.

- ▶ For bar graph display examples, see page 2-36 in section 2.3.3, “Setting the Display”.

Color scale band

Setup Item	Selectable Range or Options	Default Value
Band area	Off, In, Out	Off
Color	24 colors (red, green, blue, blue violet, brown, orange, yellow-green, light blue, violet, gray, lime, cyan, dark blue, yellow, light gray, purple, black, pink, light brown, light green, dark gray, olive, dark cyan, and spring green) and a user-defined color (1 color)	
Display position Lower	Span Lower to Span Upper	0.00
Display position Upper	Span Lower to Span Upper	1.00

Band area

Displays a specified section of the measurement range using a color band on the scale. This setting is shared with the bar graph display.

Options	Description
Off	Disables the function.
In	Displays the area inside using the color band.
Out	Displays the area outside using the color band.

Color

Set the display color.

- For instructions on how to set the user-defined color, see “Operation Example 2” on page 2-13.

Display position Lower and Display position Upper

Set the display position. Set a value within the span or scale range.

- For color band display examples, see page 2-36 in section 2.3.3, “Setting the Display”.

Alarm point mark



Setup Item	Selectable Range or Options	Default Value
Indicate on scale	Off, On	On
Mark kind	Alarm, Fixed	Alarm
Alarm 1 color to Alarm 4 color*	24 colors (red, green, blue, blue violet, brown, orange, yellow-green, light blue, violet, gray, lime, cyan, dark blue, yellow, light gray, purple, black, pink, light brown, light green, dark gray, olive, dark cyan, and spring green) and a user-defined color (1 color)	

* You can set this when the Mark kind is set to **Fixed**.

Indicate on scale

Set this to **On** to display alarm point marks on the scale. Set this to **Off** to not display them. This setting is shared with the bar graph display.

Mark kind

Options	Description	Mark Shape
Alarm	Displayed normally in green. Displayed in the specified color when an alarm occurs.	 or 
Fixed	Displayed with a fixed color.	

Alarm 1 color to Alarm 4 color

When Mark kind is set to **Fixed**, set the display colors of point marks for alarm levels 1 to 4.

2.9.6 Setting Constants to Use in Computation

Path

Web application: **Config. tab > Math channel settings > Constant**
 Hardware configurator: **Math channel settings > Constant**

Description

Number of constant

Displays a range of constant numbers (K001 to K100).

Constant

Setup Item	Selectable Range or Options	Default Value
K001 to K100	–9.999999E+29 to 9.999999E+29 –9.999999E+29 to –1.000000E–30, 0, 1.000000E–30 to 9.999999E+29	0

K001 to K100

Set the constant. The number of significant digits of a constant is eight. When specifying a constant using exponential notation, set the mantissa using up to 8 digits and the exponent using up to 2 digits. The constants in the range specified by **Number of constant** are displayed.

2.9.7 Setting Variable Constants to Use in Computation

Variable constants are constants that can be varied even when computation or recording is in progress. They can be used for math and logic math.

You can vary variable constants on the setting screen or tuning screen (when the PID control module is installed).

Path

Web application: **Config. tab > Math channel settings > Variable constant**
 Configurator: **Math channel settings > Variable constant**

Description

Number of constant

Displays a range of constant numbers (W001 to W100) to be set (in units of 10 numbers).

Value

Setup Item	Selectable Range or Options	Default Value
W001 to W100	–9.999999E+29 to 9.999999E+29 –9.999999E+29 to –1.000000E–30, 0, 1.000000E–30 to 9.999999E+29	0

W001 to W100

Set the constant. The number of significant digits of a constant is eight. When specifying a constant using exponential notation, set the mantissa using up to 8 digits and the exponent using up to 2 digits. The constants in the range specified by **Number of constant** are displayed.

2.10 Configuring Logic Math (/MT option)

Set the logic math operation. Logic math is a function that outputs calculated results as 0 or 1 to relays (DOs) or internal switches.

2.10.1 Logic Math Number, Output Destination, Calculation expressions

Path

Web application: **Config.** tab > **Logic math settings**
Hardware configurator: **Logic math settings**

Description

Logic math number

Up to 50 numbers can be set. Shows the number (LM01 to LM50) to assign logic math to.

Output

Setup Item	Selectable Range or Options	Default Value
Type	Off, Relay,1 Internal switch2	Off
Number	DO channel or internal switch	

- 1 You can set this when the range type of the DO channel is set to Manual.
- 2 You can set this when the internal switch type is set to Manual.

Type

Select the output of the logic math number to use.

Number

Select the output number of the calculated result. You can only select internal switch numbers, relay (DO) channels, or PID control module's DO with the type set to manual.

Expression

Type	Computing Element
Auxiliary operation	+, -
Basic arithmetic	+, -, *, /
Relational operation	.GT., .GE., .LT., .LE., .EQ., .NE., >, >=, <, <=, =, <>
Logical operation	AND, OR, NOT, XOR
Conditional operation	[expression 1 ? expression 2 : expression 3]
Bit operation	BIT.Bnn()

Up to 120 characters can be entered in a calculation expression.

Data That Can Be Used in Expressions

- See page 2-71 in section 2.9.2, "Setting Expressions".

Note

You cannot change the calculation expression while recording is in progress.

Description

The internal switch or relay output is 0 when the calculated result of logic math is as follows (or 1 otherwise).

- When the calculated result is greater than -0.5 and less than 0.5
- When the calculated result is in error

Operation Interval

Computation and updating of the output operate at the scan interval. However, if the scan interval is less than 100 ms, it runs at 100 ms.

If the measurement mode is set to dual interval, logic math runs according to the master scan interval.

Starting

Operation starts when the logic math setting is changed to a value other than off. It is not affected by the starting and stopping of math, recording or control.

About the Logic Math Data (LM)

Logic math data is used when you want the result of a logic math operation to be reflected in the operation of another logic math number in the same period. The function returns a 1 when the logic math operation outputs a 1 and 0 when the operation outputs a 0. The function also returns a 0 when the output type of the specified logic math number is set to Off.

The data cannot be used in the calculation expression of a math channel. LM values are retained only during the same scan interval.

Operating Conditions

The relay (DO channel) values used in logic math are displayed values (values that reflect energized or de-energized).

Logic math is applied to the internal switches and relays (DOs) after the next interval. If you want to reflect the results of logic math within the same interval, use logic math data (LM).

Example: Differences in the logic math results depending on the calculation expression

	Logic math number	Output		Expression	
		Output type	Output No.	Setting 1	Setting 2
Settings	LM01	Internal switch	1	W001	W001
	LM02	Internal switch	2	S001	LM01
	LM03	Internal switch	3	S002	LM02
Results	First interval		Internal switch 1	1	1
			Internal switch 2	0	1
			Internal switch 3	0	1
	Second interval		Internal switch 1	1	1
			Internal switch 2	1	1
			Internal switch 3	0	1
	Third interval		Internal switch 1	1	1
			Internal switch 2	1	1
			Internal switch 3	1	1

If multiple logic math operations set the same output, the result of the logic math with the largest logic math number is reflected. However, for the logic math data (LM), the calculated result of that number is reflected.

Example: When multiple logic math operations specify the same output

Settings

Logic math 1 (LM01)

Output type: Internal switch

Output No.: 1

Calculation expression: W001 (W001 is set to 1)

Logic math 2 (LM02)

Output type: Internal switch

Output No.: 1

Calculation expression: W002 (W002 is set to 0)

Values after calculation

Internal switch 1 = 0

LM01=1

LM02=0

2.11 Setting Display Conditions

Set the display conditions.

2.11.1 Setting the Trend Interval

This setting is not available when the measurement mode is High speed and Dual interval.

Path

Web application: **Config.** tab > **Display settings** > **Trend interval**
Hardware configurator: **Display settings** > **Trend interval**

Description

Setup Item	Selectable Range or Options	Default Value
Trend interval [/div] (recording interval) ¹	5s (100ms), ^{2,3} 10s (200ms), ^{2,3} 15s (500ms), ² 30s (1s), 1min (2s), 2min (4s), 5min (10s), 10min (20s), 15min (30s), 20min (40s), 30min (1min), 1h (2min), 2h (4min), 4h (8min), 10h (20min) 1min (2s)	1min (2s)

- 1 Does not appear if the recording mode is set to Event in basic settings under recording settings
- 2 Cannot be specified if an electromagnetic relay type module is in use (configured).
- 3 Cannot be specified if a low withstand voltage relay type module is in use (configured).

Trend interval [/div]

Set the trend interval.

Relationship between the Scan Interval and Trend Interval

The shortest trend interval that you can specify varies depending on the scan interval.

Scan Interval	Shortest Trend Interval
100 ms	5 s
200 ms	10 s
500 ms	15 s
1 s	30 s
2 s	1 min
5 s	5 min

Explanation

If the recording mode is set to Event, the trend interval depends on the recording interval of event data.

2.11.2 Setting Display Groups

Assign channels and set the group name for each display group. Set lines at specified positions in the waveform display range on the Trend display.

- ▶ If you want to use the multi-batch function (/BT option), see the multi-batch function manual (IM 04L51B01-03EN).

Path

Web application: **Config. tab > Display settings > Group settings > Group No. (display example: 1-20)**

Hardware configurator: **Display settings > Group settings > Group No. (display example: 1-20)**

Description

Group number

Select the target group number.
GM10-1: 50, GM10-2: 60

Group settings

Setup Item	Selectable Range or Options	Default Value
On/Off	Off, On	Off
Group name	Character string (up to 16 characters, Aa#1)	—
Scan group*	1/2	1
Channel set	Up to 20 channels	—

* You can set this when the measurement mode is set to Dual interval.

On/Off

Set this to **On** to use the target group number.

Group name

Set the group name.

Scan Group

When the measurement mode is set to dual interval, set the measurement group number to assign to the group.

Channel set

Select from AI channels, DI channels, DO channels, math channels (/MT option), and communication channels (/MC option).

- In the Channel set dialog box, you can drag channels to change the displayed order of the channels in the group. The order is applied on the monitor display.
 - ▶ For the procedure, see "Operation Example 3" on page 2-14.

Trip line 1 to 4

Set lines at specified positions in the waveform display range on the Trend display.

Setup Item	Selectable Range or Options	Default Value
On/Off	Off, On	Off
Position	0 to 100 %	50
Color	24 colors (red, green, blue, blue violet, brown, orange, yellow-green, light blue, violet, gray, lime, cyan, dark blue, yellow, light gray, purple, black, pink, light brown, light green, dark gray, olive, dark cyan, and spring green) and a user-defined color (1 color)	—

On/Off

Set this to **On** to display trip lines.

Position

Set the display position in the range of 0 to 100% of the display width.

Color

Set the display color.

2.11.3 Setting Messages

Path

Web application: **Config. tab > Display settings > Message settings**
 Hardware configurator: **Display settings > Message settings**

Description

Message number

Displays the message number (1 to 100) to be set.

Message

Setup Item	Selectable Range or Options	Default Value
Message 1 to 100	Character string (up to 32 characters, Aa#1)	—

Message 1 to 100

Assign a message to the message number.

Writing Messages

You can recall preset messages and write them. With free messages, you can set messages when you need to write them.

For the procedure, see “Writing Messages” on page 3-14.

2.11.4 Setting Trend Display Conditions

Path

Web application: **Config. tab > Display settings > Trend settings**
 Hardware configurator: **Display settings > Trend settings**

Description

Message

Setup Item	Selectable Range or Options	Default Value
Power-fail message	Off, On	Off

Power-fail message

Set this to **On** to write power-fail messages.

When the GM recovers from a power failure, a message is written.

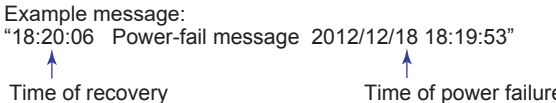
Options	Description
On	Automatically writes the message when the GM recovers from a power failure. Example message: “18:20:06 Power-fail message 2012/12/18 18:19:53” 
Off	Disables the feature.

2.11.5 Turning the Operation from the Monitor Displays On and Off

Path

Web application: **Config. tab > Display settings > Screen display settings**
 Hardware configurator: **Display settings > Screen display settings**

Description

Changing each value from monitoring

Setup Item	Selectable Range or Options	Default Value
On/Off	Off, On	Off

On/Off

Set this to On to enable users to change alarm values, perform alarm ACK (when individual alarm ACK is enabled), and control DO or AO from the monitor displays (trend, digital, bar graph, and overview)

- For the procedure, see page 3-8 in section 3.1.2, "Monitoring the GM Data and Controlling the GM from the Monitor Screen".

2.12 Setting Measurement Conditions (Scan interval, A/D integrate, etc.)

Set the scan interval, A/D integrate, measurement groups, etc.

2.12.1 Setting the Scan Interval

When the measurement mode is set to Dual interval, see page 2-112 in section 2.14, “Configuring the Dual Interval Settings (Release number 4 and later)”.

Path

Web application: **Config.** tab > **Measurement settings** > **Scan interval**
Hardware configurator: **Measurement settings** > **Scan interval**

Description

Scan interval

Setup Item	Selectable Range or Options	Default Value
Scan interval	1ms, ⁴ 2ms, ⁴ 5ms, ⁴ 10ms, ⁴ 20ms, ⁴ 50ms, ⁴ 100ms, ^{1,3} 200ms, ^{1,3} 500ms, ¹ 1s, 2s, 5s	1 s ²

- 1 Cannot be specified if an electromagnetic relay type analog input module is in use (configured).
- 2 2 s if an electromagnetic relay type analog input module is in use.
- 3 Cannot be specified if a low withstand voltage relay type analog input module is in use (configured).
- 4 You can set this when the measurement mode is High speed.

Scan interval

Set the scan interval. The scan intervals that you can set are displayed depending on the installed modules.

When the measurement mode is High speed and the scan interval is 1 ms or 2 ms, the following limitations apply to the number of valid channels of high-speed universal type.

Scan interval	Channel limitations*
1ms	All channels except channel 1 of each module are set to Skip.
2ms	Channels 3 and 4 of each module are set to Skip.

- * Channels set to skip as a result of changing the scan interval are not changed from display group channel settings or recording channel settings.

2.12.2 Setting the Over-range Detection Method

Path

Web application: **Config. tab > Measurement settings > Over-range**
 Hardware configurator: **Measurement settings > Over-range**

Description

Over-range

Setup Item	Selectable Range or Options	Default Value
Value on over-range	Free, Over	Over

Value on over-range

Set how to detect over-range values on linearly scaled or square-rooted I/O channels. In either case, +over range occurs if the value excluding the decimal point exceeds 99999 and –over range if it falls below –999999.

Options	Description
Free	The value is set to –over range if the value is less than –5% of the measurable span range and +over range if the value is greater than 105%.
Over	The value is set to –over range if the value is less than –5% of the span setting (Linear scaling or , Square root span) and +over range if the value is greater than 105%. They are displayed as –Over and +Over. Example: If the linear scaling scale is 0.0 to 200.0, a value less than –10.0 results in a –over range, and a value greater than 210.0 results in a +over range.

2.12.3 Setting the Operation Mode of a Module

Path

Web application: **Config. tab > Measurement settings > Module operation settings**
 Hardware configurator: **Measurement settings > Module operation settings**

Description

AI Modules

Operation mode

Setup Item	Selectable Range or Options	Default Value
Operation mode	AI modules other than those below	2ch Only, Low noise mode; 10ch Normal mode
	4-wire RTD/resistor type	2ch mode (low noise), 6ch mode (normal)
	Electromagnetic relay type, low withstand voltage relay type	Fixed to 10ch mode
	High-speed universal	10ch mode
		Cannot be set.
		—

Operation mode

Set the operation mode to use. For details on the operation modes, see the explanation.

DI Modules or DI/DO Modules

Operation mode

Setup Item	Selectable Range or Options	Default Value
Operation mode	Remote, Normal	Normal

Operation mode

Set the operation mode to use. For details on the operation modes, see the explanation.

Explanation

2ch Mode and 6ch/10ch Mode (AI modules)

In 10ch mode, measurement is possible on CH1 to CH10.

In 6ch mode, measurement is possible on CH1 to CH6.

In 2ch mode, measurement is possible only on CH1 and CH2. (CH3 and higher channels are fixed to **Skip**.)

In 6ch/10ch mode, when the scan interval is set to 100 ms or 200 ms, the A/D integration time is fixed at 1.67 ms. This prevents power frequency noise from being eliminated, causing measured values to wobble (especially for temperature). In 2ch mode, when the scan interval is 100 ms or 200 ms, the A/D integration time is 16.67 ms or 20 ms. This allows power frequency noise to be eliminated.

Note that the selectable A/D integration times vary depending on the 2ch/6ch/10ch mode and scan interval settings.

Normal and Remote (DI modules)

Specify Remote to use the DI as a remote control input.

When there are multiple DI modules, only one of them can be set to Remote.

Remote can only be specified for a DI module or DI/DO module linked to the GM main unit.

For normal DI input, specify Normal.

When using Event action, set to Remote.

► For remote control using event action, see page 2-135 in section 2.20, "Configuring the Event Action Function".

Operation mode DI input

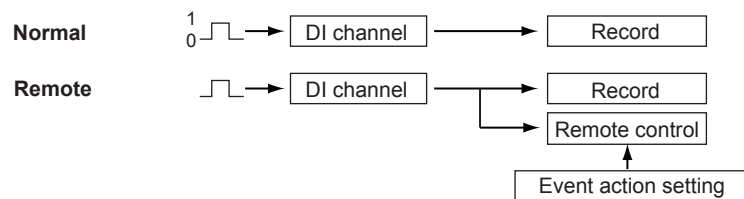

2.12.4 Setting the A/D Integral Time (Other than high-speed AI or PID control modules)

Path

Web application: **Config.** tab > **Measurement settings** > **Module operation settings**
 Hardware configurator: **Measurement settings** > **Module operation settings**

Description

A/D integrate

Setup Item	Selectable Range or Options	Default Value
A/D integrate	Auto, 50Hz, 60Hz, Common ¹	Auto

¹ You can specify **Common** when the scan interval is 500 ms or longer (1 s or longer for a low withstand voltage relay type).

A/D integrate

Set the module's A/D integration time. The available options appear depending on the scan interval setting.

Options	Description
Auto	The GM automatically detects the power supply frequency and sets the A/D integration time to 16.67 ms for 60 Hz and 20 ms for 50 Hz. However, if the module operation mode is 10ch/6ch and the scan interval is 100 ms or 200 ms, the A/D integration time is fixed at 1.67 ms.
50Hz	Sets the integration time to 20 ms.
60Hz	Sets the integration time to 16.67 ms.
Common	Sets the integration time to 16.67 ms, 20 ms, 36.67 ms, or 100 ms. Integration time and scan interval by module

Type	Integration time	Scan interval	
		10ch mode / 6ch mode	2ch mode
Universal	36.67ms	1s	
Current (mA) input	100ms	2s or 5s	
4-wire RTD/resistance			
High withstand voltage			
Electromagnetic relay	16.67ms/20ms	1s	—
	36.67ms	2s	—
	100ms	5s	—
Low withstand voltage relay	36.67ms	2s	—
	100ms	5s	—

Explanation

Integration Time of the A/D Converter

The GM uses an A/D converter to convert sampled analog signals to digital signals. The power supply frequency noise can be effectively eliminated by setting the integration time of the A/D converter to match the time period corresponding to one cycle of the power supply or an integer multiple of one cycle.

Common (36.67 ms/100 ms) can be specified to effectively eliminate power supply frequency noise for both 50 Hz and 60 Hz.

2.12.5 Setting the Noise Rejection (High-speed AI, PID control module) (Release number 4 and later)

Path

Web application: **Config.** tab > **Measurement settings** > **Module operation settings**
 Hardware configurator: **Measurement settings** > **Module operation settings**

Description

Noise rejection

Setup Item	Selectable Range or Options	Default Value
Noise rejection	Auto, 50Hz, 60Hz, Common ¹	2

- Common** can be set when the scan interval is longer than 100 ms. For PID control modules, this is fixed to Common.
- Depends on the scan interval. Refer to the noise rejection that are available depending on the scan interval.

Noise rejection

Set the noise rejection. The available options appear depending on the scan interval setting. For PID control modules, this is fixed to Common.

Options	Description
Auto	The GM automatically detects the power supply frequency and rejects 50 Hz noise for 50 Hz or 60 Hz noise for 60 Hz. However, noise is not rejected if the scan interval is set to 1 ms, 2 ms, 5 ms, or 10 ms.
50Hz	50 Hz noise is rejected.
60Hz	60Hz noise is rejected.
Common	50 Hz and 60 Hz noise is rejected simultaneously.

Noise rejection that is available depending on the scan interval

Scan interval	Noise rejection that is available	Default value	Filter
1ms	Auto	Auto	None
2ms			
5ms			
10ms			
20ms	Auto 50Hz 60Hz	Auto	None
50ms	Auto 50Hz 60Hz	Auto	50 Hz or 60 Hz auto selection 50Hz 60Hz
100ms	Common	Common	50 Hz and 60 Hz simultaneous rejection
200ms			
500ms			
1s			
2s			
5s			

2.12.6 Setting the Burnout Criteria

Set the upper and lower limits for determining burnout for when the range type is set to GS or GS (4-20mA).

Path

Web application: **Config. tab > Measurement settings > Module operation settings**
Hardware configurator: **Measurement settings > Module operation settings**

Description

Lower limit of burnout set (%), Upper limit of burnout set (%)

Setup Item	Selectable Range or Options	Default Value
Lower limit of burnout	-20.0 to -5.0 %	-10.0 (AI module) -20.0 (PID module)
Upper limit of burnout	105.0 to 120.0 %	110.0 (AI module) 120.0 (PID module)

Lower Limit of Burnout

Set the lower limit for determining burnout.
Set as a percentage of the specified span width.

Upper Limit of Burnout

Set the upper limit for determining burnout.
Set as a percentage of the specified span width.

2.12.7 Setting the Chattering Filter for Pulse Input

You can set this filter on a DI module or DI/DO module when the GM10 (/MT option) operation mode is set to **Normal**.

To set the chattering filter of a pulse input module, use the pulse input channel settings.

▶ See page 2-51 in section 2.5.1, "Setting the Range".

Path

Web application: **Config. tab > Measurement settings > Module operation settings**
Hardware configurator: **Measurement settings > Module operation settings**

Description

Chattering filter for pulse input

Setup Item	Selectable Range or Options	Default Value
Chattering filter for pulse input	On, Off	On

Explanation

This filter prevents pulse count errors caused by chattering or noise. By default, the chattering filter for pulse input is set to On. This is because the pulse input of DI modules and DI/DO modules may be affected by noise. In normal situations, set the chattering filter for pulse input to On.

2.13 Setting Recording Conditions (Recording mode, recording interval, saving interval)

Set the type of data to record (event or display data), the recording interval, and the interval for saving measurement data files to an SD card.

When the measurement mode is Dual interval, the recording setting menu does not appear. For details on recording conditions in this situation, see page 2-112 in section 2.14, "Configuring the Dual Interval Settings (Release number 4 and later)".

2.13.1 Setting the Type of Data to Record (Event or display data) and Recording Conditions

Path

Web application: **Config. tab > Recording settings > Recording basic settings**
 Hardware configurator: **Recording settings > Recording basic settings**

Description

Recording mode

Setup Item	Selectable Range or Options	Default Value
File type	Display, ² Display + Event, ^{1,2} Event	Event

- 1 This is not available when you are using the advanced security function (/AS option) or multi-batch function (/BT option).
- 2 You cannot set this when the measurement mode is High speed or Dual interval.

File type

Set the type of data to record.

When the measurement mode is High speed or Dual interval, this is fixed to Event.

Setup Item	Description
Display	Records display data
Display + Event	Records display and event data
Event	Records event data

Event data¹

Setup Item	Selectable Range or Options	Default Value
Recording interval	1ms, ⁷ 2ms, ⁷ 5ms, ⁷ 10ms, ⁷ 20ms, ⁷ 50ms, ⁷ 100ms, ⁴ 200ms, ⁴ 500ms, ⁴ 1s, 2s, 5s, 10s, 15s, 20s, 30s, 1min, 2min, 5min, 10min, 15min, 20min, 30min	1s ⁵
Recording mode	Free, Single ⁶ , Repeat ⁶	Free
Data length	2min, 5min, 10min, 20min, 30min, 1h, 2, h, 3h, 4h, ² 6h, 8h, 12h, 1day, 2day, 3day, 5day, 7day, 14day, 31day	
Pre-trigger ³	0%, 5%, 25%, 50%, 75%, 95%, 100%	0%
Trigger source operation ³	Off, On	On

- 1 You can set this when the file type is set to Display + Event or **Event**.
- 2 The minimum effective data length based on the recording interval of event data and the number of recording channels.
- 3 You can set this when the mode is not set to **Free**.
- 4 Cannot be specified if an electromagnetic relay type analog input module is in use (configured).
- 5 2 s if an electromagnetic relay type analog input module is in use.
- 6 This is not available when you are using the advanced security function (/AS option) or multi-batch function (/BT option).
- 7 You can set this when the measurement mode is High speed or Dual interval.

Recording Interval

Set the event data recording interval. You cannot choose a recording interval shorter than the scan interval or a recording interval that is not an integer multiple of the scan interval.

Note

When the measurement mode is set to Normal

- The maximum number of channels that the GM can record varies depending on the recording interval and file type.

Recording Interval	GM10-1		GM10-2	
	Event	Display + Event	Event	Display + Event
100 ms	100ch	100ch	500ch	100ch
200 ms	200ch	200ch	500ch	200ch
500 ms	500ch	500ch	1000ch	500ch
1 s or more	500ch	500ch	1000ch	1000ch

When the measurement mode is set to High speed or Dual interval

- There is a limit to the number of channels that can record at scan intervals shorter than 100 ms.

For limitations, see the limitations provided in the *GM Data Acquisition System General Specifications* (GS 04L55B01-01EN).

Recording mode

Set the mode for recording event data.

Options	Description
Free	Records data at all times
Single	Records data when the trigger condition is met
Repeat	Records data every time the trigger condition is met

Free

Recording starts when you start it and stops when you stop it.

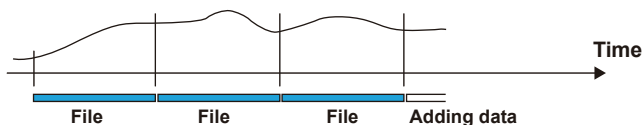

Single

The GM enters the trigger-wait state when you start recording. After a trigger event occurs, the GM will record data for the specified time (data length) and stop. From this point, the GM will not record even if the trigger condition is met.

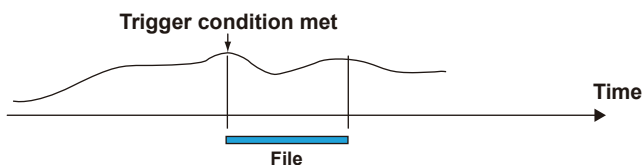

Repeat

The GM enters the trigger-wait state when you start recording. After a trigger event occurs, the GM will record data for the specified time (data length) and stop. Then, it enters the trigger-wait state again and repeats recording for the specified time (data length) every time the trigger condition is met. To stop recording event data, stop the recording.

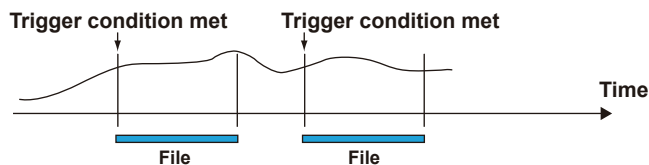

2.13 Setting Recording Conditions (Recording mode, recording interval, saving interval)

Data length

Set the size of recording data per file. Recording data is divided at the specified file size. The selectable data lengths vary depending on the number of channels to record and the **Recording Interval** setting.

A file is also created in the following instances.

- When a file is created manually
- When recording is stopped
- When file creation is executed with the event action function
- After recovering from a power failure

Recording Interval*	1 ms	2 ms	5 ms	10 ms	20 ms
Selectable range of data length	2 min to 10 min	2 min to 20 min	2 min to 1 hour	5 min to 2 hours	5 min to 4 hours
Recording Interval*	50 ms	100 ms	200 ms	500 ms	1 s
Selectable range of data length	10 min to 8 hours	10 min to 1 days	10 min to 2 days	10 min to 3 days	10 min to 7 days
Recording Interval*	2 s	5 s	10 s	15 s	20 s
Selectable range of data length	10 min to 14 days	10 min to 31 days	10 min to 31 days	10 min to 31 days	10 min to 31 days
Recording Interval*	30 s	1 min	2 min	5 min	10 min
Selectable range of data length	1 hour to 31 days	1 hour to 31 days	1 hour to 31 days	1 hour to 31 days	1 hour to 31 days
Recording Interval*	15 min	20 min	30 min		
Selectable range of data length	1 hour to 31 days	1 hour to 31 days	1 hour to 31 days		

* You cannot choose a recording interval that is shorter than the scan interval.

Pre-trigger

Set the range of data to record before the trigger point. Set this value as a percentage of the data length. If you do not want to record data before the trigger point, set this to 0%. Pre-trigger enables you to record data before an event, such as an alarm.

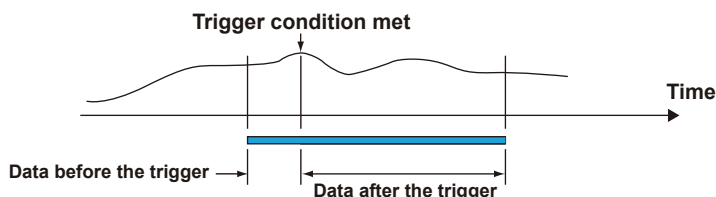

Trigger source operation

Select **On** to apply triggers through the **User function key** of the event action function.

Note

- The event trigger can be used from the Web Page.
 - See "Triggering the Starting of Event Data Recording" on page 3-5
- When you start recording, recording will start if the trigger condition is met.

Display Data, Trend Waveform

Setup Item	Selectable Range or Options	Default Value
Saving interval ¹	10min, 20min, 30min, 1h, 2, h, 3h, 4h, 6h, 8h, 12h, 1day, 2day, 3day, 5day, 7day, 14day, 31day	²

- You cannot set this when the file type is set to **Event**.
- The minimum effective saving interval based on the trend interval of display data and the number of recording channels.

Note

- The maximum number of channels that the GM can record varies depending on the trend interval and file type.

Trend Interval (Unit: /div)	GM10-1		GM10-2	
	Display	Display + Event	Display	Display + Event
5s	100ch	100ch	200ch	100ch
10s	200ch	200ch	500ch	200ch
15s	500ch	500ch	1000ch	500ch
30s or more	500ch	500ch	1000ch	1000ch

Saving interval

Set the size of recording data per file. Recording data is divided at the specified file size. The options vary depending on the number of channels to record and the **Saving interval** setting.

The divided files can be connected with the universal viewer. However, you can not connect files that have stopped recording.

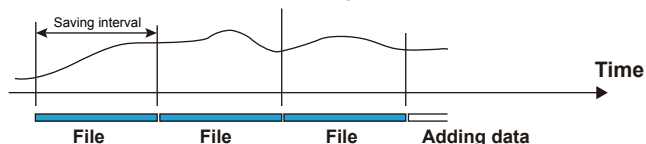

A file is also created in the following instances.

- When a file is created manually
- When recording is stopped
- When file creation is executed with the event action function
- After recovering from a power failure

Trend Interval and Display Data Recording Interval

Trend Interval*	5 s	10 s	15 s	30 s	1 min
Recording interval	100 ms	200 ms	500 ms	1 s	2 s
Selectable range of file save interval	10 min to 12 hours	10 min to 1 days	10 min to 3 days	10 min to 7 days	10 min to 14 days
Trend Interval*	2 min	5 min	10 min	15 min	20 min
Recording interval	4 s	10 s	20 s	30 s	40 s
Selectable range of file save interval	10 min to 14 days	10 min to 31 days	10 min to 31 days	10 min to 31 days	1 hour to 31 days
Trend Interval*	30 min	1 h	2 h	4 h	10 h
Recording interval	1 min	2 min	4 min	8 min	20 min
Selectable range of file save interval	1 hour to 31 days	1 hour to 31 days	2 hour to 31 days	4 hour to 31 days	8 hour to 31 days

* You cannot choose a recording interval that is shorter than the scan interval.

Explanation

Event Data and Display Data

There are two file types: event data and display data.

Event data is useful when you wish to record the measured data in detail.

In the case of event data, the GM records the measured values at every recording interval (Instantaneous data in each scan interval).

Display data can be likened to the conventional recording on the chart sheet and are useful for long-term recording.

In the case of display data, the GM records the maximum and minimum values from the measured values within each recording interval (Instantaneous data in each scan interval).

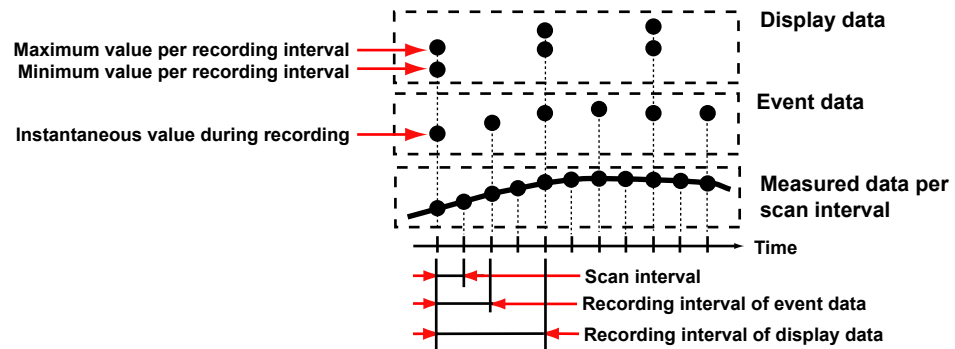

Refer to the examples below, and record data that suits your purpose.

Example 1: Continuously record the waveform data as with the conventional chart recorder.
Record the display data.

Setup Items
File type: Display data

Example 2: Record waveform data under normal conditions but record details around the point of alarm occurrence when alarms occur.
Record detailed data.
Continuously record display data and record event data when alarms occur.

Setup Items
File type: Display + Event data
Recording mode: Single or Repeat

Example 3: Record the most-detailed data at all times.
Record event data by specifying the recording interval.

Setup Items
File type: Event data
Recording mode: Free

Example 4: No need to continuously record data. Record data only when alarms occur.
Record event data only when alarms occur.

Setup Items
File type: Event data
Recording mode: Single or Repeat

Data Types

The GM can record the following types of data.
If you are using the advanced security function (/AS option), see section 1.2.1, "Data Types," in the Advanced Security Function User's Manual (IM 04L55B01-05EN).

Data Type	Description
Event data	<ul style="list-style-type: none"> Measured data that is recorded at the specified recording interval. There are two modes. One mode starts recording when a trigger occurs. The other mode records at all times. A header string (shared with other files) can be written in the file. Event data contains alarm and message information. Data format: Binary (undisclosed), text
Display data	<ul style="list-style-type: none"> Waveform data displayed on the trend display. The measured data is recorded at the specified trend interval. The minimum and maximum values among the measured data within the trend interval are saved. A header string (shared with other files) can be written in the file. Event data contains alarm and message information. Data format: Binary (undisclosed), text
Manual sampled data	<ul style="list-style-type: none"> Instantaneous value of the measured data when a manual sample operation is executed. A header string (shared with other files) can be written in the file. Data format: Text
Report data (/MT option)	<ul style="list-style-type: none"> Hourly, daily, weekly, monthly, batch, daily custom report data. Report data is created at an interval that is determined by the report type (one hour for hourly reports, one day for daily reports, and so on). A header string (shared with other files) can be written in the file. Data format: Text The data can be converted to Excel and PDF formats.
Setting parameter	<ul style="list-style-type: none"> The setting parameters of the GM. Data format: Text
Alarm summary data	<ul style="list-style-type: none"> This is the alarm summary information saved in the internal memory. Data format: Text format The data can be saved to an SD card.
Health monitor log data	<ul style="list-style-type: none"> This is the health monitor log data. Data format: Text format The data can be saved to an SD card.

Flow of Data Recording and Storage

Measured data is recorded once to the internal memory and then saved to the external storage medium.

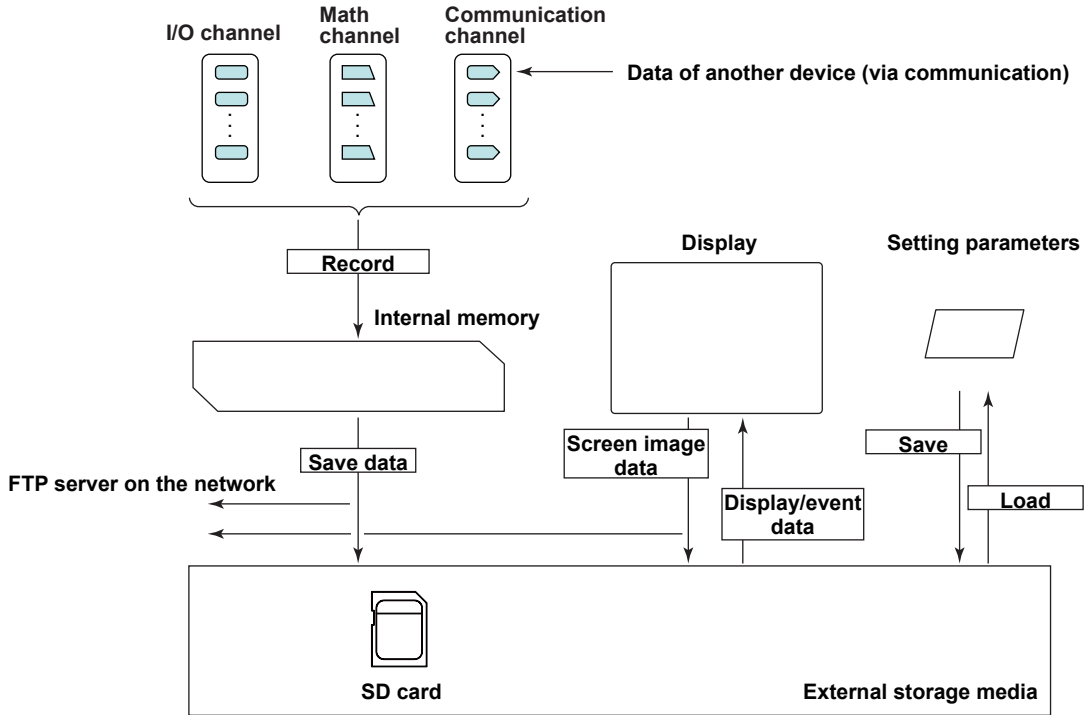

Internal Memory

Display data and event data are held in files in the internal memory. This data is also saved as files to a storage medium.

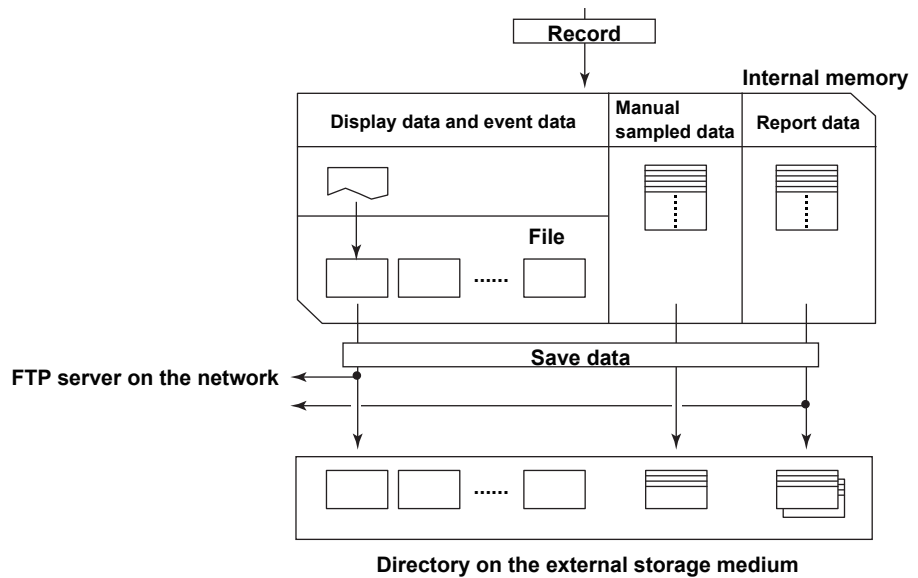

2.13.2 Configuring Recording Channels

Path

Web application: **Config. tab > Recording settings > Recording channel settings**
 Hardware configurator: **Recording settings > Recording channel settings**

Description

Setup Item	Selectable Range or Options	Default Value
Display data, Trend waveform	AI, DI, DO, AO, PID, math, communication channels	—
Event data	AI, DI, DO, AO, PID, math, communication channels	—
Manual sample	AI, DI, DO, AO, PID, math, communication channels	—

Display data, Trend waveform

Set the channels for recording display data. Channels that you can specify are displayed.

Event data

Set the channels for recording event data. Channels that you can specify are displayed. If you specify more than the number of recordable channels, the recording interval will automatically change to a setting that is possible (see Note).

Manual sample

Set the channels for recording manual sampled data. Channels that you can specify are displayed.

Number of Recording Channels

Model	Maximum Number of Channels
GM10-1	50
GM10-2	100

Manual sampled data is recorded to internal memory. If the number of manual sampled data entries exceeds 400, the data is overwritten from the oldest entry.

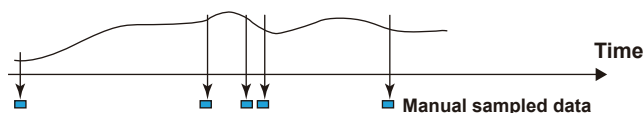

Note

- When the measurement mode is set to Normal
- The maximum number of channels that the GM can record varies depending on the recording interval and file type.

Display data

Trend Interval (Unit: /div)	GM10-1		GM10-2	
	Display	Display + Event	Display	Display + Event
5s	100ch	100ch	200ch	100ch
10s	200ch	200ch	500ch	200ch
15s	500ch	500ch	1000ch	500ch
30s or more	500ch	500ch	1000ch	1000ch

Event data

Recording interval	GM10-1		GM10-2	
	Event	Display + Event	Event	Event + Display
100ms	100ch	100ch	500ch	100ch
200ms	200ch	200ch	500ch	200ch
500ms	500ch	500ch	1000ch	500ch
1 s or more	500ch	500ch	1000ch	1000ch

When the measurement mode is set to High speed or Dual interval

- There is a limit to the number of channels that can record at scan intervals shorter than 100 ms.

For limitations, see the limitations provided in the *GM Data Acquisition System General Specifications* (GS 04L55B01-01EN).

2.14 Configuring the Dual Interval Settings (Release number 4 and later)

These settings apply when the measurement mode is set to Dual interval.

2.14.1 Setting the Scan Interval

Path

Web application: **Config.** tab > **Dual interval settings** > **Scan interval**
Hardware configurator: **Dual interval** > **Scan interval**

Description

Scan interval

Setup Item	Selectable Range or Options	Default value
Measurement group 1	1ms ^{1, 3, 4, 5}	1s ²
	2ms ^{1, 3, 4, 5}	
	5ms ^{1, 3, 4, 5}	
	10ms ^{1, 3, 4, 5}	
	20ms ^{1, 3, 4, 5}	
	50ms ^{1, 3, 4, 5}	
	100ms ^{1, 3, 4}	
	200ms ^{1, 3, 4}	
	500ms ^{1, 4}	
	1s	
	2s	
	5s	
Measurement group 2	100ms ^{1, 3, 4}	2s
	200ms ^{1, 3, 4}	
	500ms ^{1, 4}	
	1s,	
	2s	
	5s	

- 1 You cannot specify this value on sub unit (unit 1 to unit 6) modules.
- 2 2s when an electromagnetic relay type module is used in the same scan group..
- 3 You cannot specify this value when a low withstand voltage relay type module is used in the same scan group.
- 4 You cannot specify this value when an electromagnetic relay type module is used in the same scan group.
- 5 You can specify this value when only a high-speed universal type module is in use. However, can not settings 1 ms and 2 ms for GM10-1.

Measurement group 1

Set the scan interval of measurement group 1. You can select from the scan intervals available depending on the installed module.

Measurement group 2

Set the scan interval of measurement group 2. You can select from the scan intervals available depending on the installed module.

Note

You cannot set the scan intervals of measurement group 1 and measurement group 2 to the same value.

Master Scan Interval

Setup Item	Selectable Range or Options	Default value
Measurement group number	Measurement group 1, measurement group 2	Measurement group 1

Measurement group number

Set the measurement group number with the scan interval that you want to use as the master scan interval.

2.14.2 Setting the Scan Interval of Each Module

Path

Web application: **Config. tab > Dual interval settings > Scan interval**
 Hardware configurator: **Dual interval settings > Scan interval**

Description

Main Unit Module Scan Interval, Unit 1 to Unit 6 Module Scan Interval

Setup Item	Selectable Range or Options	Default value
Measurement group number	Measurement group 1, measurement group 2	—

Measurement group number

Set the scan group with the scan interval that you want the module to run at.

2.14.3 Setting the Recording Conditions

Path

Web application: **Config. tab > Dual interval settings > Recording settings**
 Hardware configurator: **Dual interval settings > Recording settings**

Description

Recording mode

Setup Item	Selectable Range or Options	Default value
File type	Event (fixed)	Event

File type

Records event data

Event data (Measurement group 1)

Setup Item	Selectable Range or Options	Default value
Recording interval	1ms, 2ms, 5ms, 10ms, 20ms, 50ms, 100ms, 200ms, 500ms, 1s, 2s, 5s, 10s, 15s, 20s, 30s, 1min, 2min, 5min, 10min, 15min, 20min, 30min	1s
Recording mode	Free, Single, Repeat	Free
Data length	2min, 5min, 10min, 20min, 30min, 1h, 2, h, 3h, 4h, 6h, 8h, 12h, 1day, 2day, 3day, 5day, 7day, 14day, 31day	1h
Pre-trigger ³	0%, 5%, 25%, 50%, 75%, 95%, 100%	0%
Trigger source operation ³	Off, On	On

Recording interval

Set the event data recording interval. You cannot choose a recording interval shorter than the scan interval or a recording interval that is not an integer multiple of the scan interval.

Recording mode

Set the mode for recording event data.

Setup Item	Description
Free	Records data at all times
Single	Records data when the trigger condition is met
Repeat	Records data every time the trigger condition is met

Data length

Set the size of recording data per file. Recording data is divided at the specified file size. The selectable data lengths vary depending on the number of channels to record and the Recording Interval setting.

A file is also created in the following instances.

- When a file is created manually
- When recording is stopped
- When file creation is executed with the event action function
- After recovering from a power failure

Event data (Measurement group 2)

Setup Item	Selectable Range or Options	Default value
Recording interval	100ms, 200ms, 500ms, 1s, 2s, 5s, 10s, 15s, 20s, 30s, 1min, 2min, 5min, 10min, 15min, 20min, 30min	2s
Recording mode	Free, Single, Repeat	Free
Data length	10min, 20min, 30min, 1h, 2, h, 3h, 4h, 6h, 8h, 12h, 1day, 2day, 3day, 5day, 7day, 14day, 31day	1h

Recording interval

Set the event data recording interval. You cannot choose a recording interval that is shorter than the scan interval.

Recording mode

This is the same as Measurement group 1.

Data length

This is the same as Measurement group 1.

2.14.4 Configuring Recording Channels

Path

Web application: **Config. tab > Dual interval settings > Recording channel settings**
 Hardware configurator: **Dual interval settings > Recording channel settings**

Description

Event data (Measurement group 1)

Setup Item	Selectable Range or Options	Default value
Event data	AI, DI, pulse input, AO, DO, math, communication channels	—

Event data

Set the channels for recording event data with measurement group 1. Channels that you can specify are displayed.

Event data (Measurement group 2)

Setup Item	Selectable Range or Options	Default value
Event data	AI, DI, pulse input, AO, DO, math, communication channels	—

Event data

Set the channels for recording event data with measurement group 2. Channels that you can specify are displayed.

Manual sample

Set the channels for recording manual sampled data. Channels that you can specify are displayed.

Setup Item	Selectable Range or Options	Default value
Manual sample	AI, DI, pulse input, AO, DO, math, communication channels	—

Manual sample

Set the channels for recording manual sampled data. Channels that you can specify are displayed.

Number of Recording Channels

Model	Maximum number of channels
GM10-1	50
GM10-2	100

2.15 Setting the Conditions for Saving Data Files

Set the conditions for saving data files.

- ▶ If you want to use the multi-batch function (/BT option), see the multi-batch function manual (IM 04L51B01-03EN).

2.15.1 Setting the Save Directory, File Header, and File Name

Path

Web application: **Config.** tab > **Data save settings**
 Hardware configurator: **Data save settings**

Description

Save directory

Setup Item	Selectable Range or Options	Default Value
Directory name	Character string (up to 20 characters, A a# 1)	DATA0

Directory name

Set the name of the directory on the storage medium for saving data.

Characters that cannot be used: ' ; " * / : < > ? \ |

Spaces are not allowed in the beginning or end of names.

Names cannot be all spaces.

Strings that cannot be used: AUX, CON, PRN, NUL, CLOCK, CLOCK\$, COM0 to COM9, LPT0 to LPT9

- If a character or string that cannot be used is entered, it is changed to an underscore when the entry is completed.

Note

Do not place a file with the same name as the directory name ("DATA0" by default) in the storage medium for saving data.

File header

Setup Item	Selectable Range or Options	Default Value
Characters	Character string (up to 50 characters, A a# 1)	—

Characters

Enter a header comment to write into data files.

Data file name

Setup Item	Selectable Range or Options	Default Value
Structure	Date, Serial, Batch*	Date
Identified strings	Character string (up to 16 characters, A a# 1)	—

* Appears when the batch function is set to **On**.

Structure

Sets the structure of the file name when saving data.

Options	Description
Date	Serial number + specified string + date The date reflects the date and time when recording was started to the relevant file.
Serial	Serial number + specified string
Batch Name	Serial number + batch (when using the batch function)

Identified strings

Set the user-assigned character string.

Characters that cannot be used: ' ; " * / : < > ? \ |

Explanation

File name

You can select what type of file name to use to save measured data to an SD card. The following three types are available.

If you are using the advanced security function (/AS option), see section 1.2.8, “Saving Data to External Storage Medium,” in the Advanced Security Function User’s Manual (IM 04L55B01-05EN).

Structure	Description	
Date	Display data Event data ¹ Manual sampled data Snapshot data Alarm data Health monitor log data	<div style="border: 1px solid black; padding: 2px; display: inline-block;"> Serial Specified string Date . Extension </div> Example: 000123_AAAAAAAAAAAAA121231_174633.GDS
	Report data	<div style="border: 1px solid black; padding: 2px; display: inline-block;"> Serial Specified string Date Type . Extension </div> Example: 000123_AAAAAAAAAAAAA121231_174633HD.GRE
Serial	Display data Event data ¹ Manual sampled data Snapshot data Alarm data Health monitor log data	<div style="border: 1px solid black; padding: 2px; display: inline-block;"> Serial Specified string . Extension </div> Example: 000123_AAAAAAAAAAAAA.GDS
	Report data	<div style="border: 1px solid black; padding: 2px; display: inline-block;"> Serial Specified string Type . Extension </div> Example: 000123_AAAAAAAAAAAHD.GRE
Batch	Display data Event data ¹	<div style="border: 1px solid black; padding: 2px; display: inline-block;"> Serial Batch name . Extension </div> Example: 000123_BBBBBBBBBBBBBBBBBBBBBBBBBBBBBB.GDS
	Report data	<div style="border: 1px solid black; padding: 2px; display: inline-block;"> Serial Date Type . Extension </div> Example: 000123_121231_174633HD.GRE
	Manual sampled data Alarm data Health monitor log data	<div style="border: 1px solid black; padding: 2px; display: inline-block;"> Serial Date . Extension </div> Example: 000123_121231_174633.GMN

¹: For measurement group 2 when the measurement mode is set to Dual interval, “S” is attached to the front of the file name.
Example when Structure is set to Date: S00123_AAAAAAAAAAAAA121231_174633.GEV

Item	Description	
Serial	<div style="border: 1px solid black; padding: 2px; display: inline-block;"> 6-digit number + 1-character delimiter </div>	
	6-digit number	A number that indicates the file’s order of occurrence. The number ranges from 000001 to 999999. If the number reaches 999999, it returns to 000000.
	1-character delimiter	Starts with ‘_’ and takes on the following values: A to Z and 0 to 9. If a file with the same name exists in the specified directory, the file is saved by changing the delimiter to prevent overwriting. Example: If a file named “000123_AAAAAAAAAAAAA.GDS” already exists, the file is saved to the name “000123AAAAAAAAAAAA.GDS.”
Date	YYMMDD_hhmmss	YY: Year (lower two digits) MM: Month, DD: Day hh: Hour, mm: minute, ss: Second The date reflects the date and time when recording was started to the relevant file.
Specified string	AAAAAAAAAAAAA	Up to 16 alphanumeric characters can be used.
Batch name	BBBBBBBBBBBBBB***B	Up to 41 alphanumeric characters can be used.
Type	H_, D_, W_, M_, HD, DW, DM, B_, C_	Report data types H_: Hourly, D_: Daily, W_: Weekly, M_: Monthly, HD: Hourly and daily, DW: Daily and weekly, DM: Daily and monthly, B_: Batch, C_: Daily custom
Extension	Display data: GDS Event data: GEV Manual sampled data: GMN Alarm summary data: GAL Display data (text): GTD Event data (text): GTE	Report data: GRE Report data: xlsx or xlsm (report template function) Report data: pdf (report template function) Health monitor log data ² : GHL

²: If you save the health monitor log manually, the serial number is fixed at 0.

2.15.2 Setting the Save Method to Media (Auto save or manual save) and Media FIFO

Path

Web application: **Config.** tab > **Data save settings**
 Hardware configurator: **Data save settings**

Description

Media save

Setup Item	Selectable Range or Options	Default Value
Auto save	Off, On	On
Media FIFO*	Off, On	Off

* You can set this when **Auto save** is set to On.

Auto save

Set this to **On** to automatically save measured data. To save measured data manually, set this to **Off**.

Options	Description
On	Automatically saves measured data to an SD card Set this to On to use the media FIFO.
Off	Measured data is not saved automatically. The data in the internal memory is saved at once when an external storage medium is inserted.

Media FIFO

Set this to **On** to use media FIFO.

Options	Description
On	Enables media FIFO. Constantly retains the most recent data files in an SD card.
Off	Disables media FIFO. Replace the SD card if the free space on it drops low.

Note

If you are not using media FIFO, the SD card must have adequate free space to store all the data; otherwise, the GM will not be able to save the data from the internal memory. Replace the SD card and save the data before the data in the internal memory is overwritten.

Explanation

Internal Memory

The recorded measured data is divided at a specific time interval (saving interval) and saved to files. If the internal memory is full or if the number of display data files and event data files exceeds 500 for the GM10-1 or 1000 for the GM10-2, files are overwritten from the oldest file.

Auto Save

• When Media FIFO Is Not in Use

Keep the SD card inserted in the drive at all times. The data in the internal memory is automatically saved to the SD card.

If there is not enough free space on the SD card, the GM cannot save the data in the internal memory to the SD card.

Replace the SD card and save the data before the data in the internal memory is overwritten.

• Auto Save Timing

Data Type	Description						
Display data	The file is saved when the file is created.						
Event data	Same as the display data.						
Manual sampled data	<p>The first time manual sample is executed, a manual sampled data file is created on the SD card. The data is appended to this file for each subsequent manual sample operation. A new file is created after manual sampled data is stored 100 times.</p> <p>▶For operating instructions, see "Executing Manual Sampling" on page 3-5.</p>						
Report data	<p>The first time report data is generated, a report data file is created on the SD card and report data is stored. The report data is appended to this file every time a report is created.</p> <p>Dividing of the report files</p> <p>The appending of the report data to the file is stopped at a specified time, and subsequent reports are saved to a new file. The file is divided in the unit shown in the table below. Also, when recording is stopped, all report files are divided.</p> <p>Report template</p> <p>Every time a report file is divided, a report file is created according to the specified template format such as an XML spreadsheet format or PDF format. The report file can also be printed.</p> <p>▶For the setup procedure, see page 2-124 in section 2.17, "Configuring the Report Function (/MT option)".</p>						
Report kind	<table border="1"> <thead> <tr> <th>Report File</th> <th></th> </tr> </thead> <tbody> <tr> <td>Separate</td> <td>Combine</td> </tr> </tbody> </table>	Report File		Separate	Combine		
Report File							
Separate	Combine						
Hourly and daily reports	<table border="1"> <thead> <tr> <th>Separate</th> <th>Combine</th> </tr> </thead> <tbody> <tr> <td><input type="checkbox"/> a file for each daily report</td> <td><input type="checkbox"/> hourly reports for a day and a daily report</td> </tr> <tr> <td><input type="checkbox"/> hourly reports for a day</td> <td></td> </tr> </tbody> </table>	Separate	Combine	<input type="checkbox"/> a file for each daily report	<input type="checkbox"/> hourly reports for a day and a daily report	<input type="checkbox"/> hourly reports for a day	
Separate	Combine						
<input type="checkbox"/> a file for each daily report	<input type="checkbox"/> hourly reports for a day and a daily report						
<input type="checkbox"/> hourly reports for a day							
Daily and weekly reports	<table border="1"> <thead> <tr> <th>Separate</th> <th>Combine</th> </tr> </thead> <tbody> <tr> <td><input type="checkbox"/> a file for each weekly report</td> <td><input type="checkbox"/> daily reports for a week and a weekly report</td> </tr> <tr> <td><input type="checkbox"/> daily reports for a week</td> <td></td> </tr> </tbody> </table>	Separate	Combine	<input type="checkbox"/> a file for each weekly report	<input type="checkbox"/> daily reports for a week and a weekly report	<input type="checkbox"/> daily reports for a week	
Separate	Combine						
<input type="checkbox"/> a file for each weekly report	<input type="checkbox"/> daily reports for a week and a weekly report						
<input type="checkbox"/> daily reports for a week							
Daily and monthly reports	<table border="1"> <thead> <tr> <th>Separate</th> <th>Combine</th> </tr> </thead> <tbody> <tr> <td><input type="checkbox"/> a file for each monthly report</td> <td><input type="checkbox"/> daily reports for a month and a monthly report</td> </tr> <tr> <td><input type="checkbox"/> daily reports for a month</td> <td></td> </tr> </tbody> </table>	Separate	Combine	<input type="checkbox"/> a file for each monthly report	<input type="checkbox"/> daily reports for a month and a monthly report	<input type="checkbox"/> daily reports for a month	
Separate	Combine						
<input type="checkbox"/> a file for each monthly report	<input type="checkbox"/> daily reports for a month and a monthly report						
<input type="checkbox"/> daily reports for a month							
Batch reports	<table border="1"> <thead> <tr> <th>Separate</th> <th>Combine</th> </tr> </thead> <tbody> <tr> <td><input type="checkbox"/> a file for each recording start/stop operation The file will be divided if the number of data entries exceeds 200.</td> <td><input type="checkbox"/> a file for each recording start/stop operation The file will be divided if the number of data entries exceeds 200.</td> </tr> </tbody> </table>	Separate	Combine	<input type="checkbox"/> a file for each recording start/stop operation The file will be divided if the number of data entries exceeds 200.	<input type="checkbox"/> a file for each recording start/stop operation The file will be divided if the number of data entries exceeds 200.		
Separate	Combine						
<input type="checkbox"/> a file for each recording start/stop operation The file will be divided if the number of data entries exceeds 200.	<input type="checkbox"/> a file for each recording start/stop operation The file will be divided if the number of data entries exceeds 200.						
Daily custom	<table border="1"> <thead> <tr> <th>Separate</th> <th>Combine</th> </tr> </thead> <tbody> <tr> <td><input type="checkbox"/> a file for each file creation unit</td> <td><input type="checkbox"/> a file for each file creation unit</td> </tr> </tbody> </table>	Separate	Combine	<input type="checkbox"/> a file for each file creation unit	<input type="checkbox"/> a file for each file creation unit		
Separate	Combine						
<input type="checkbox"/> a file for each file creation unit	<input type="checkbox"/> a file for each file creation unit						
Health monitor log data	When the log reaches 100, the file is saved.						

• **When Media FIFO Is in Use**

If not enough free space is available when saving a new data file to the SD card, files are deleted in order from the oldest data update date/time to save the new file. This operation is referred to as FIFO (first in first out).

When saving the data files automatically, you can save the data so that the most recent data files are constantly retained in the SD card. This method allows you to use the GM continuously without having to replace the SD card.

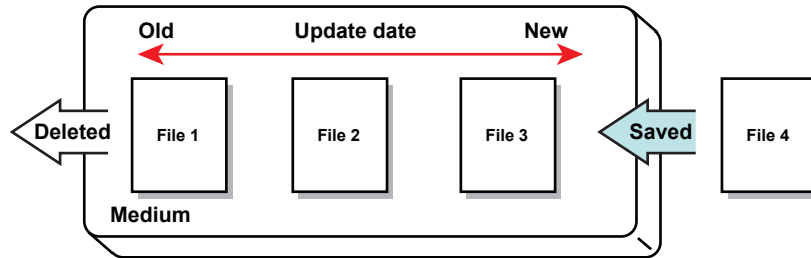

Media FIFO Save Operation

- FIFO is used only when the following files are saved automatically. When files are saved using other methods, FIFO is not used.
 - Display data files, event data files, report data files, manual sample data files, and snapshot data files
- Files subject to deletion
 - All files in the destination directory, except for the ones listed below, are subject to deletion. However, the following files are excluded.
 - Hidden files, read-only files, files in the subdirectory within the save destination directory
- Up to the most recent 1000 files are retained. If the number of files in the save destination directory exceeds 1000, the number of files is held at 1000 by deleting old files even if there is enough free space.
- If there are more than 1000 files already in the save destination directory, at least one file is always deleted before saving the new file. The number of files is not kept within 1000 in this case.

Manual Save (Collectively storing unsaved data)

When automatic saving is set to Off, unsaved data in the internal memory is stored in files to the external storage medium (SD card) when an external storage medium is inserted.

When using manual save, it is important that you save the data in the internal memory to the external storage medium before the data is overwritten. Determine the usage condition of the internal memory and save the data to the external storage medium at appropriate times.

- ▶ For details on the manual save operation, see “Saving Event Data” on page 3-5 or “Saving Display Data” on page 3-5.

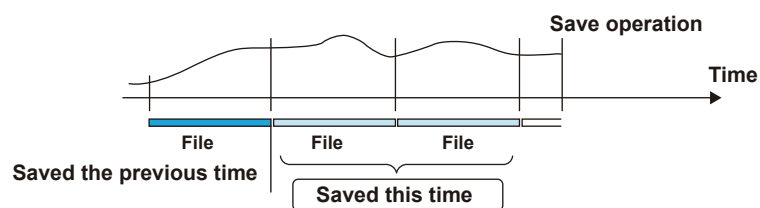

2.15.3 Setting the File Format of Display Data and Event Data

Path

Web application: **Config.** tab > **Data save settings**
 Hardware configurator: **Data save settings**

Description

File format

Setup Item	Selectable Range or Options	Default Value
Display/Event data	Binary, Text *	Binary

* This is not available when you are using the advanced security function (/AS option).

Display/Event data

Set the file format of display data and event data.

Text format is TSV (tab separated).

When the measurement mode is set to Dual interval or High speed, this is fixed to **Binary**.

2.16 Configuring the Batch Function

Set the batch function. You can add batch information to display data and event data files. You can manage display data and event data files using batch information.

2.16.1 Configuring the Batch Function (Lot-No. digit and Auto increment)

Path

Web application: **Config.** tab > **Batch settings** > **Batch function**
Hardware configurator: **Batch settings** > **Batch function**

Description

Batch function

Setup Item	Selectable Range or Options	Default Value
On/Off	Off, On	Off
Lot-No. digit*	Off/4/6/8	6
Auto increment*	Off, On	On

* You can set this when the batch function is set to **On**.

On/Off

Set this to **On** to use the batch function.

Lot No.

Set the number of digits of lot numbers. To disable lot numbers, set this to **Off**.

Auto increment

Options	Description
On	Automatically sets the lot number of the next measurement to the current lot number + 1.
Off	Turns auto increment off.

2.16.2 Setting Batch Text (When the batch function is set to On)

Path

Web application: **Config.** tab > **Batch settings** > **Batch text**
Hardware configurator: **Batch settings** > **Batch text**

Description

Setup Item	Selectable Range or Options	Default Value
Text field number	1 to 24	1

Text field number

Select the text field number to assign text to.

Text field

Setup Item	Selectable Range or Options	Default Value
Title of field	Character string (up to 20 characters, Aa#1)	—
Characters	Character string (up to 30 characters, Aa#1)	—

Title of field

Set the title for the text field number you selected.

Characters

Set the characters for the text field number you selected.

Explanation**Batch Function**

- **Batch Number and Lot Number**

Display data and event data files can be identified by their “batch number-lot number” (hereinafter referred to as batch name). The lot number does not have to be specified.

- Batch number (up to 32 characters)
- Lot number (up to 8 digits)

- **Automatic Increment of the Lot Number**

The lot number can be automatically incremented when the recording is stopped.

- **Text Field**

You can enter text fields into a file. There are 24 available text fields. Each text field consists of the following:

- Field title (up to 20 characters)
- Field string (up to 30 characters)

You can use the touch screen to display text fields on the GM screen.

- **Batch Comment**

You can enter up to three comments in a file. You can enter each comment once during recording.

Comment 1, Comment 2, and Comment 3 (up to 50 characters each)

Using the Batch Function

You can enter text in measurement data files.

See the figure below.

For example, you can enter the operator name and administrator name in text fields.

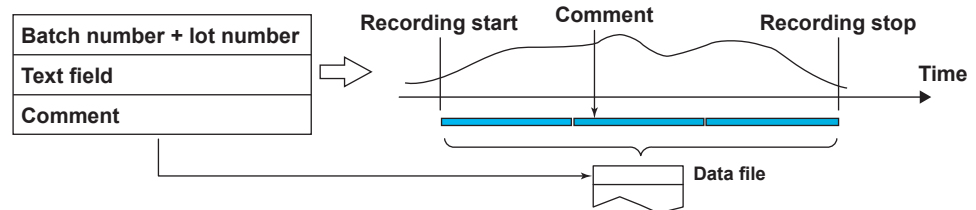

► For the procedure, see “Starting Recording” on page 3-2.

2.17 Configuring the Report Function (/MT option)

Set the report function. When the measurement mode is set to High speed or Dual interval, there is a limit to the number of report channels at scan intervals shorter than 100 ms. For limitations, see the *GM Data Acquisition System General Specifications* (GS 04L55B01-01EN).

2.17.1 Setting the Report Type, Creation Time, Data Type, Etc.

Path

Web application: **Config**. tab > **Report settings** > **Report basic settings**
 Hardware configurator: **Report settings** > **Report basic settings**

Description

Type

Setup Item	Selectable Range or Options	Default Value
Type	Off, Hourly + Daily, Daily + Weekly, Daily + Monthly, Batch, Daily custom	Off

Type

Set the kind of report to create.

Options	Description
Off	Disables the report function.
Hourly + Daily	Creates hourly and daily reports. Hourly report: Creates report data every hour on the hour for the previous one hour. Daily report: Creates report data every day at a specified time for the previous one day.
Daily + Weekly	Creates hourly and weekly reports. Weekly report: Creates report data every week at a specified time at a specified day of the week for the previous one week.
Daily + Monthly	Monthly report: Creates report data every month at a specified time at a specified day for the previous one month.
Batch	Creates a report in unit of batches.
Daily custom	Creates daily reports by dividing it at the specified time intervals.

Creation time¹

Setup Item	Selectable Range or Options	Default Value
Day	1 to 28	1
Day of the week	Sunday, Monday, Tuesday, Wednesday, Thursday, Friday, Saturday	Sunday
Hour	1 to 23	0
Minute	0 to 59	0
Save interval ²	2min, 3min, 4min, 5min, 10min, 15min, 30min, 1h	10min
File creation interval	4h, 6h, 8h, 12h, 24h	4h

1 You can set this when the kind of report is not set to **Off**.

2 You can set this when the type is set to **Batch** or **Daily custom**.

Depending on the kind of report, set the items with ✓ marks in the table below.

Setup Item	Kind				
	Hourly + Daily	Daily + Weekly	Daily + Monthly	Batch	Daily custom
Day			✓		
Day of the week		✓			
Hour of the day	✓	✓	✓		✓
Minute					✓
Save interval				✓	✓
File creation interval					✓

Day, Day of week, Hour, Minute

Set the day or day of week and the time to create reports.

Save interval (for Batch and Day custom)

Set the data recording interval.

File creation interval (for Day custom)

Set the time interval for dividing files.

Data type

Setup Item	Selectable Range or Options	Default Value
Report 1 to 5	Ave, Max, Min, Sum, Inst, Off*	—

* You can set this for Report 2 to Report 5.

Report 1 to 5

Set the data type to output as reports.

Options	Description
Ave	Outputs average values.
Max	Outputs maximum values.
Min	Outputs minimum values.
Sum	Outputs sum values.
Inst	Outputs instantaneous values.

File type*

Setup Item	Selectable Range or Options	Default Value
File type	Separate, Combine	Combine

* You can set this when the Type is not set to **Batch** or **Daily custom**.

File type

Set this item when creating two types of reports such as daily report and monthly report.

Options	Description
Separate	Saves each type of report to a separate file. ► For information about how files are divided, see page 2-118 in section 2.15.2, "Setting the Save Method to Media (Auto save or manual save) and Media FIFO".
Combine	Saves the report data of two types in a single file.

Report template output

Setup Item	Selectable Range or Options	Default Value
Excel file	Off, On	Off
PDF file	Off, On	Off
Printer	Off, On	Off

Excel file

Set this to **On** to output in Excel format.

PDF file

Set this to **On** to output in PDF format.

Printer

Set this to **On** to output to a printer.

► For instructions on how to set the output destination printer, see page 2-186 in section 2.26.6, "Setting the Printer Output Conditions".

Electric Signature

Setup Item	Selectable Range or Options	Default Value
PDF Electronic Signature	Off, On	Off

PDF Electronic Signature

Set this to **On** to electronically sign a PDF file.

To use electronic signature, you need to create a key and a certificate.

► See page 2-214 in section 2.30, “Configuring Key Creation, Certificate Management, and Encryption/Certificate (SSL communication, PDF electronic signature)”.

Text File

Setup Item	Selectable Range or Options	Default Value
Attach batch information	Off, On	Off

Attach batch information

Set this to **On** to output text data of report files by attaching batch information. If the file division mode is **Separate**, batch information is attached to each file.

Note

- If the multi-batch function (/BT option) is enabled, batch information cannot be attached.
- Batch information cannot be output in report template output (Excel file, PDF file, printer output).

Explanation

Report Data Values

The range of report data values is from -9999999 to 99999999 excluding the decimal point.

Saving the Report Data

Report data is saved to the internal memory. If the number of report data entries exceeds 800, the data is overwritten from the oldest entry.

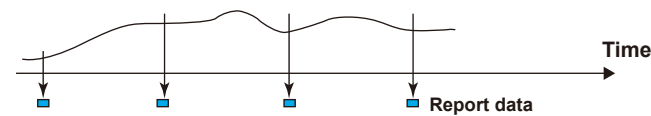

Daily custom

You can create daily reports by dividing files at the specified time interval (file creation interval).

For example, in a three-shift system, you can set the file creation interval to 8 hours to create a file for each shift.

2.17.2 Setting the Channels to Output Reports

Path

Web application: **Config. tab > Report settings > Report channel settings**
 Hardware configurator: **Report settings > Report channel settings**

Description

Setup Item	Selectable Range or Options	Default Value
Report channel number	1 to 60	1

Report channel number

Select the report channel number. The GM generates reports in order by this number.

Report channel

Setup Item	Selectable Range or Options	Default Value
Channel type	IO channel, Math channel, Communication channel, Off	—
Channel number*	Channels that you can set	—
Sum scale*	Off, /s, /min, /h, /day	—

* You can set this when the channel type is not set to **Off**.

Channel type

Set the channel type to assign to the report channel.

Channel no

Set the channel number to assign to the report channel. All channels can be assigned, but reports are not created for channels set to **Skip** or **Off** even if they are assigned.

Sum scale

Set the sum scale to match the unit of the measured values.

Example: If the unit of the measured value is "m³/min," select **min**.

Off: The measured data is summed as-is once per scan interval.

Explanation**Unit of Sum Computation**

In sum computation, data is summed over the scan interval. However, for flow values that have units /s, /min, /h, or /day a simple summation results in the actual value not matching the computed result, because the scan interval and the unit of the input values are different. In such cases, set the sum scale to match the unit of the input value. In effect, the sum value with the same unit as that of the input value is computed.

For example, if the scan interval is 2 s, and the input value is 100 m³/min, a simple summation would add 100 every 2 s resulting in 3000 after one minute. However, if the sum scale is set to /min, then 2 s/60 s is multiplied every scan interval before the value is added giving a result that has an m³ unit.

The following converting equations are used to compute the sum. The scan interval unit is seconds.

Off: $\Sigma(\text{measured data every scan interval})$

/s: $\Sigma(\text{measured data every scan interval}) \times \text{scan interval}$

/min: $\Sigma(\text{measured data every scan interval}) \times \text{scan interval}/60$

/h: $\Sigma(\text{measured data every scan interval}) \times \text{scan interval}/3600$

/day: $\Sigma(\text{measured data every scan interval}) \times \text{scan interval}/86400$

Report Processing when the Measurement Mode Is Set to Dual Interval

Report computation is performed at the scan interval of each measurement group. For example, if a channel of measurement group 1 is assigned to a report channel, computation on that report channel is performed at the scan interval of measurement group 1. A single report file will be created.

Report Processing When the Measurement Mode Is Set to High Speed

Report computation is performed at the scan interval.

Maximum Number of Report Channels

The following table shows the maximum number of report channels depending on the measurement mode.

Measurement mode		
Normal	High speed	Dual interval
60	60	30

2.18 Using the Report Template Function (/MT option)

You can create report templates and use them to automatically create custom report files. Load a report template file that you have created into the GM10 internal memory. The GM10 will automatically create report files using the report template file.

A report template file can be used to create report files in Excel format, create report files in PDF format, and print reports on a printer connected over the LAN. The GM can handle template files that are 1 MB or smaller.

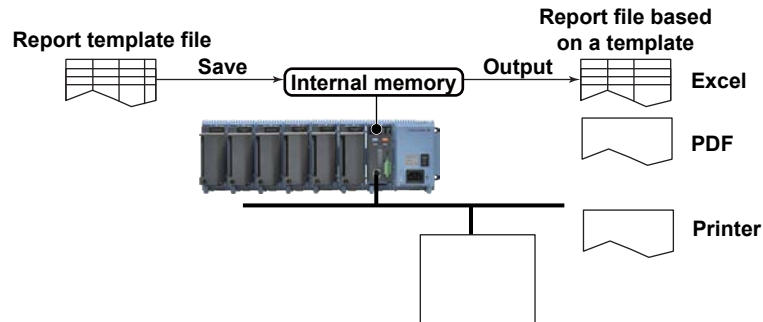

- ▶ Creating a report template: page App-17 in Appendix 4, “Creating Report Templates”
- ▶ Loading and saving report templates: page 2-195 in section 2.28.3, “Saving and Loading Report Templates (/MT option)”

2.18.1 Excel Report Files

- ▶ For instructions on how to create templates, see page App-17 in Appendix 4, “Creating Report Templates”.

Template

Item	Description
Format, extension	Excel format. The extension is .xlsx or .xlsm (with macro) (lowercase).
File name	Assign a file name of your choosing.
Kind	A report template for each kind of report file is created. The kinds of report files available are hourly, daily, weekly, monthly, hourly + daily, daily + weekly, daily + monthly, batch, and day custom.
Creation method	Create templates using Microsoft Office 2007 or later.

Excel Report Files

Item	Description
Format, extension	Excel format. You can open the file with Excel. The extension is .xlsx or .xlsm (with macro).
File name	The file name excluding the extension is the same as the report file with the .GRE extension. ▶ File Name: page 2-116 in section 2.15.1, “Setting the Save Directory, File Header, and File Name”
Kind	For each kind of report file, a corresponding template file is used to create the appropriate report files. The report file that you create is based on the report creation setting. For example, if the GM is not configured to create daily reports, you will not be able to use a report template to create daily reports. However, regardless of this setting, you can output the data of all data types (average, maximum, minimum, sum, and instantaneous).

2.18.2 PDF Report Files

- ▶ For instructions on how to create templates, see page App-17 in Appendix 4, “Creating Report Templates”.

Template

Item	Description
Format, extension	Yokogawa proprietary format. The extension is .tpl (lowercase).
File name	Assign a file name of your choosing.
Kind	A report template for each kind of report file is created. The kinds of report files available are hourly, daily, weekly, monthly, hourly + daily, daily + weekly, daily + monthly, batch, and day custom.
Creation method	Create templates using a YOKOGAWA’s original tool.

PDF Report Files

Item	Description
Format, extension	PDF format. The extension is .pdf (lowercase).
File name	The file name excluding the extension is the same as the report file with the .GRE extension. ▶File Name: page 2-116 in section 2.15.1, “Setting the Save Directory, File Header, and File Name”
Kind	For each kind of report file, a corresponding template file is used to create the appropriate report files. The report file that you create is based on the report creation setting. For example, if the GM is not configured to create daily reports, you will not be able to use a report template to create daily reports. However, regardless of this setting, you can output the data of all data types (average, maximum, minimum, sum, and instantaneous).

2.18.3 Printing on a Printer over the LAN

Report template

The report template for PDF reports is used to output data to the printer.

Printer output

Item	Description
Compatible printers	Printers supporting the HP PCL5c language and can print through port 9100 on a LAN connection ▶For configuring the printer, see page 2-186 in section 2.26.6, “Setting the Printer Output Conditions”.
Kind	For each kind of report file, the specified template file is used to create the appropriate report files. The report file that you create is based on the report creation setting. For example, if the GM is not configured to create daily reports, you will not be able to create daily reports. However, regardless of this setting, you can output the data of all data types (average, maximum, minimum, sum, and instantaneous).

2.18.4 Creating Template-Based Report Files

Template-based report files are created (the creation of template-based report files will hereinafter be referred to as “template conversion”) in the following cases.

- ▶ For instructions on how to set the type of files to output, see page 2-124 in section 2.17.1, “Setting the Report Type, Creation Time, Data Type, Etc.”.

PDF Report Files and Excel Report Files

- **Auto Save**

When a report file is created (when file division occurs), template conversion is performed, and the report file is saved to the SD card. Template conversion is also performed when recording stops.

- **Manual Save (Collectively storing unsaved data)**

When you save a report file manually, template conversion is performed on the report files in the internal memory that have not yet been converted. Converted files are saved to the external storage medium.

Printer Output

When a report file is created (when file division occurs), template conversion is performed, and the report is output to a printer.

Template conversion is also performed when recording stops.

2.18.5 Loading and Saving Report Template Files

- ▶ For details on loading report template files, see page 2-195 in section 2.28.3, “Saving and Loading Report Templates (/MT option)”.

About Report Template Files

Creates a report template for each kind of report file.

If the file type is Separate, a template for each type is necessary.

Example in which the report file type is Hourly +Daily

File type	Template
Combine	An Hourly + Daily report template is necessary.
Separate	An Hourly and Daily report templates are necessary.

2.19 Setting the Timers

Set the timers that are used in the event action function and the math function (/MT option). There are two types of timers: absolute and relative. You can set up to 12 timers* for each type. You cannot change timers during recording or computing.

* For release numbers 3 and later (up to 4 timers for release numbers earlier than 3).

2.19.1 Setting the Timers

Path

Web application: **Config. tab > Timer settings > Timer**
Hardware configurator: **Timer settings > Timer**

Description

Timer: 1 to 12

Type

Setup Item	Selectable Range or Options	Default Value
Type	Off, Relative, Absolute	Off

Type

Set the timer type.

Options	Description
Relative timer	Times out at specified intervals.
Absolute timer	Expires at the times determined by the reference time and the interval.

Interval¹

Setup Item	Selectable Range or Options	Default Value
Day ²	0 to 31	0
Hour ²	0 to 23	1
Minute ²	0 to 59	0
Interval ³	1min, 2min, 3min, 4min, 5min, 6min, 10min, 12min, 15min, 20min, 30min, 1h, 2, h, 3h, 4h, 6h, 8h, 12h, 24h	1h

- 1 You can set this when the type is not set to **Off**.
- 2 You can set this when the type is set to **Relative timer**.
- 3 You can set this when the type is set to **Absolute timer**.

Day, Hour, Minute

Set the interval for the relative timer.

Interval

Set the interval for the absolute timer.

Action on Math Start^{*}

Setup Item	Selectable Range or Options	Default Value
Reset	Off, On	On

* You can set this when the type is set to **Relative timer**.

Reset

Set this to **On** to reset the timer when starting computation. Set this to **Off** to not reset. The timer does not expire (if the timer is specified as an event, the action will not be executed).

Reference time*

Setup Item	Selectable Range or Options	Default Value
Hour	0 to 23	0
Minute	0 to 59	0

* You can set this when the type is set to **Absolute timer**.

Hour, Minute

Set the reference time for the absolute timer.

Explanation**Timers**• **Relative Timer**

The timer is started when the timer is set, and the timer expires every specified interval. In this mode, the timer stops when a power failure occurs.

Example: Interval: 00:15

The timer expires every 15 minutes.

• **Absolute Timer**

The timer expires at the times determined by the reference time and the interval. The reference time is set on the hour (00 to 23).

Example: Reference time: 00:00

Interval: 10 min

The timer expires at 0 hour, 0 hour 10 min, 0 hour 20 min, . . . 23 hour 40 min, and 23 hour 50 min.

For example, if the timer is set at 9 hour 36 min, the timer expires at 09 hour 40 min, 09 hour 50 min, 10 hour, and so on.

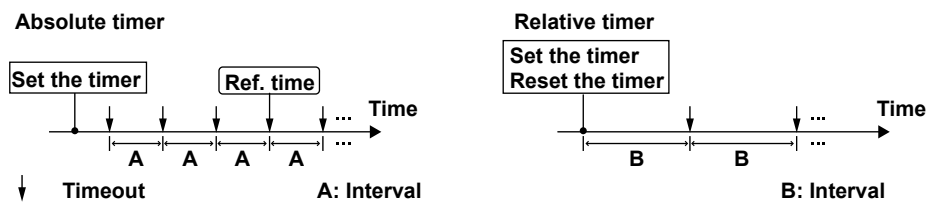
**2.19.2 Setting the Match Time Timer****Path**

Web application: **Config. tab > Timer settings > Match time timer**
 Hardware configurator: **Timer settings > Match time timer**

Description

Match time timer: 1 to 12

Type

Setup Item	Selectable Range or Options	Default Value
Type	Off, Day, Week, Month, Year	Off

Type

Set the kind of match time timer.

Options	Description
Off	Disables the function.
Day	Set the time match condition of a day.
Week	Set the time match condition of a week.
Month	Set the time match condition of a month.
Year	Set the time match condition of a year.

Timer match condition¹

Setup Item	Selectable Range or Options	Default Value
Day of week	Sunday to Saturday	Sunday
Month	January to December	January
Day	1 to 31 ²	1
Hour	0 to 23	0
Minute	0 to 59	0

- 1 You can set this when the type of timer is not set to **Off**. The items that are displayed varies depending on the Type setting.
- 2 If Type is set to **Year**, the range varies depending on the timer match condition **Month**. If Type is set to **Month**, the range is 1 to 28.

Day of Week, Month, Day, Hour, Minute

Set each timer match condition.

Depending on the Type setting, set the items with ✓ marks in the table below.

Setup Item	Type			
	Day	Week	Month	Year
Month				✓
Day			✓	✓
Day of the week		✓		
Hour:Minute	✓	✓	✓	✓

Timer action

Setup Item	Selectable Range or Options	Default Value
Timer action	Single, Repeat	Repeat

Timer action

Set the timer action.

Options	Description
Single	Executes the action once when the condition is met.
Repeat	Executes the action at every specified time.

2.20 Configuring the Event Action Function

The event action function is used to execute a specified action on the basis of events that occur. The settings explained here are also used to configure the remote control function.

2.20.1 Setting Event Action Numbers and Actions

Select an event action number, and set event action to On.
Set the even type and event-specific conditions.
Then, set the action for the event and the action conditions.

Path

Web application: **Config.** tab > **Event action** > **Event action number (display example: 1-20)**

Hardware configurator: **Event action** > **Event action number (display example: 1-20)**

Description

Event action number

Select the event action number (1 to 50) to assign an event action.

Event action

Setup Item	Selectable Range or Options	Default Value
On/Off	Off, On	Off

On/Off

Select **On** to use the event action function.

Event¹

Setup Item	Selectable Range or Options	Default Value
Type	Internal switch, Remote, ⁴ Relay, Alarm - IO channel, Alarm - Math channel, Alarm - Communication channel, Any alarm, Timer, Match time timer, User function key, Status, Health score notification ⁷	Internal switch
Number ²	IO channel, Math channel, Communication channel, Internal switch, Timer, Match time timer, User function key, Relay, Remote	1
Detail ³	When the Type is to Alarm - IO channel, Alarm - Math channel, or Alarm - Communication channel. Level 1, Level 2, Level 3, Level 4	Level 1
	When the type is set to Status . Record, Computation, User lock out ⁶ , Memory/Media error, Measurement error, Communication error	Record
Operation mode	Rising edge, Falling edge, Rising/Falling edge, Edge ⁵	Rising edge

¹ You can set this when Event action is set to **On**.

² You cannot set this when Type is set to **Any alarm** or **Status**.

³ You can set this when the Type is to Alarm - IO channel, Alarm - Math channel, Alarm - Communication channel, or Status.

⁴ You can set this when the operation mode of the DI module is set to **Remote**.

⁵ You can set this when the event is set to **Timer**, **Match time timer**, **User function key**, or **Health score notification**.

⁶ You can set this when you are using the advanced security function (/AS option).

⁷ Release number 5 and later

Type

Set the event conditions for executing the action.

Event Type	Description
Internal switch	Select the internal switch number.
Remote	Select the DI channel number of the remote control input. You cannot set this on a DI of a PID control module.
Relay	Select the DO channel number.
Alarm - I/O channel	Set the alarm of an I/O channel.* Channels of PID control modules are not included.
Alarm - Math channel	Set the alarm of a math channel.*
Alarm - Communication channel	Set the alarm of a communication channel.* You cannot set this on a DO of a PID control module with the type set to Contact output within module.
Any alarm	The change from no active alarms to one or more active alarms is regarded as an event. Alarms of PID control modules are also included.
Health score notification	An event that occurs when the health score falls to a negative value, or below the set early warning notification threshold.
Timer	Select a timer number. Timer timeout.
Match time timer	Select a match time timer number. When the time matches.
User function key	Select the user function key number.
Status	Select the status.

* Alarms whose **Logging** is set to **Off** in the alarm settings are also applicable.

Number

Set a number from the following table depending on the event type.

Event Type	Description
Internal switch	Internal switch number
Remote	DI channel number of the remote control input
Relay	Output relay number (DO channel number)
Alarm - I/O channel	I/O channel number
Alarm - Math channel	Computation channel number
Alarm - Communication channel	Communication channel number
Timer	Timer number
Match time timer	Match time timer number
User function key	User function key number

Detail

Set the alarm level and status.

Detail	Description
Alarm level 1 to 4 ¹	Alarm level (1 to 4)
Record ²	Recording in progress.
Computation ²	Computing in progress.
User lock out	User lock out occurring.
Memory/Media error ²	Internal memory or external media error
Measurement error ²	Measurement error status.
Communication error ²	Communication error status.

1 When the Type is to Alarm - IO channel, Alarm - Math channel, or Alarm - Communication channel.

2 When the type is set to **Status**.

Operation mode

Set the edge type for performing actions.

Operation mode	Description
Rising edge	The action is executed when the event changes from off to on.
Falling edge	The action is executed when the event changes from on to off.
Rising / Falling edge	When the event changes from off to on, the action is changed from off to on. When the event changes from on to off, the action is changed from on to off. You can set this on events other than Timer and Match time timer .
Edge	The action is executed when an event occurs. This applies when the event is set to Timer , Match time timer , or Health score notification .

Operation Modes That Can Be Specified Depending on the Event

The settings with ✓ marks in the table below are possible.

Event	Rising edge	Falling edge	Rising / Falling edge	edge
Remote (DI)	✓	✓	✓	
Internal switch	✓	✓	✓	
Relay (DO)	✓	✓	✓	
Alarm - IO channel	✓	✓	✓	
Alarm - Math channel	✓	✓	✓	
Alarm - Communication channel	✓	✓	✓	
Any alarm	✓	✓	✓	
Health score notification				✓
Timer				✓
Match time timer				✓
User function key				✓
Status	✓	✓	✓	

Rising edge

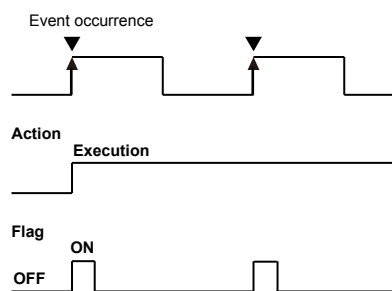

Falling edge

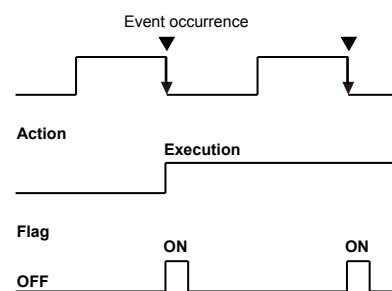

Rising / Falling edge

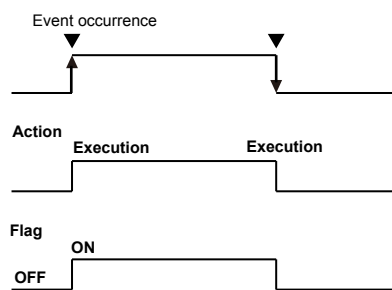

Edge (timer, match time timer)

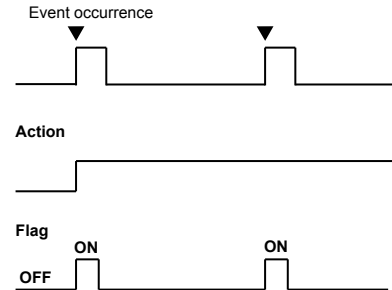

Action

Setup Item	Selectable Range or Options	Default Value
Type	<p>When the operation mode is rising edge, falling edge, or edge Recorded, Computation, Flag, Manual sample, AlarmAck, Adjust the time, Save display data, Save event data, Event trigger⁸, Message, Reset the relative timer, Load Settings, Save Settings, Relay, Internal switch, Load program pattern¹¹, Load profile trend^{11, 12, 13}, Load predictive detection model^{11, 12}, Predictive detection section¹², HOLD profile trend^{12, 13}</p> <p>When the operation mode is Rising/Falling edge Recording start/stop, Computation start/stop, Flag On/Off, Relay On/Off, Internal switch On/Off, Predictive detection section start/stop¹², HOLD profile trend On/Off¹²</p>	—
Number ¹	Depends on the type	
Detail ²	Start, ⁴ Stop, ⁴ Reset, ⁵ All groups, ⁶ Specified group, ⁶ On/Off ⁷	—
Group number ³	GM10-1: 1 to 50 GM10-2: 1 to 60	1
Batch group number ^{9, 10}	GM10-1: ALL, ¹¹ 1 to 6 GM10-2: ALL, ¹¹ 1 to 12	

- 1 You can set this when the type is set to **Flag, Message, Reset the relative timer, Flag On/Off, Relay, Relay On/Off, Internal switch, Internal switch On/Off, Load profile trend, or Load predictive detection model**.
- 2 You can set this when the type is set to **Recorded, Computation, Message, Relay, Internal switch, Predictive detection section, or HOLD profile trend**.
- 3 Appears when the type is set to **Message** and Detail is set to **Specified group**.
- 4 You can set this when the type is set to **Recorded, Computation, or Predictive detection section**.
- 5 You can set this when the type is set to **Computation**.
- 6 You can set this when the type is set to **Message**.
- 7 You can set this when the type is set to **Relay, Internal switch, or HOLD profile trend**.
- 8 This is not available when you are using the advanced security function (/AS option).
- 9 This is available when you are using the multi-batch function (/BT option).
- 10 You cannot set this when the type is set to Flag, Manual sample, or Computation start/stop. If the type is set to **Computation**, you can set this only when Detail is set to **Reset**. You cannot set this when the type is set to **Message**.
- 11 This action can be specified only when the event is set to **Remote** or **User function key**.
- 12 Release number 5 and later.
- 13 You can set this when the communication function (/MC option).

Type

Set the action to execute when an event occurs.

When the Event Operation Mode Is Rising Edge, Falling Edge or Edge

Options	Description
Recording	Starts or stops recording.
Computing	Starts or stops computation (/MT option) or resets the computed values of all math channels.
Flag	Sets the flag to 1 (On). (/MT option)
Manual sample	Executes manual sampling
Alarm ACK	Clears the alarm output DOs of PID control modules are also included.
Save display data	Saves the display data being recorded to a file in the internal memory. You can specify this when the GM is configured to record display data.
Save event data	Saves the event data being recorded to a file in the internal memory. You can specify this when the GM is configured to record event display data.
Event trigger	Applies a trigger that starts event data recording. You can specify this when the GM is configured to record event display data.
Message	Writes a message. Specify the message number and the message write destination. Set the destination to all groups, or specify a write destination group number. You can execute this while recording is in progress.
Reset the relative timer	Resets a relative timer. The timer starts immediately.
Load settings	Loads the setting parameter file in the root directory of the SD card and configures the GM accordingly. (See the explanation.)
Save settings	Saves the setting parameter file in the root directory of the SD card.

Continued on the next page

Options	Description								
Adjust the time	Sets the clock to the nearest hour.								
Relay	Sets the relay output to On or Off. DO channels of PID control modules are applicable.								
Internal switch	Sets the internal switch to On or Off.								
Load program pattern	Loads all the pattern files (ProgPatYY, YY: 01 to 99) in the specified folder at the root directory of the SD memory card. <table border="1" data-bbox="758 407 1423 533"> <thead> <tr> <th>Folder name</th> <th>Content</th> </tr> </thead> <tbody> <tr> <td>LoadProgPatXX</td> <td>XX: 01 to 10</td> </tr> <tr> <th>File name</th> <th>Content</th> </tr> <tr> <td>ProgPatYY.GPT</td> <td>YY: 01 to 99</td> </tr> </tbody> </table>	Folder name	Content	LoadProgPatXX	XX: 01 to 10	File name	Content	ProgPatYY.GPT	YY: 01 to 99
Folder name	Content								
LoadProgPatXX	XX: 01 to 10								
File name	Content								
ProgPatYY.GPT	YY: 01 to 99								
Load profile trend	Loads the specified files in the "Profile" folder at the root directory of the SD memory card. File name: Profile1 to 50								
Load predictive detection model	Loads the specified files in the "Model" folder at the root directory of the SD memory card. File name: Model1 to 50								
Predictive detection section	Starts or stops the predictive detection section.								
HOLD profile trend	Sets the HOLD profile trend to On or Off.								

When the Event Operation Mode Is Rising/Falling Edge

Options	Description
Recording start/stop	Repeats recording start and stop on every event occurrence.
Computation start/stop	Repeats computation (MT option) start and stop on every event occurrence.
Flag On/Off	Repeats the operation of setting the flag to 1 (On) and 0 (Off) on every event occurrence.
Relay On/Off	Repeats the operation of setting the relay to On and Off on every event occurrence.
Internal switch On/Off	Repeats the operation of setting the internal switch to On and Off on every event occurrence.
Predictive detection section start/stop	Repeats early warning detection interval start and stop on every event occurrence.
HOLD profile trend On/Off	Repeats pause and resume reading of the profile trend on every event occurrence.

Detail

Set the details when the action type is set to **Recorded**, **Computation**, **Message**, **Predictive detection section**, or **HOLD profile trend**.

When Set to Recorded, Computation, or Predictive detection section

Options	Description
Start	Starts recording, computation, or predictive detection section.
Stop	Stops recording, computation, or predictive detection section.
Reset (Computation only)	Resets computation.

When Set to Message

Options	Description
All groups	Writes the message to all groups.
Specified group	Writes the message to the specified group. Set the destination by specifying a group number.

When Set to Relay, Internal switch, or HOLD profile trend

Options	Description
On	Set the relay, internal switch, or HOLD profile trend to On.
Off	Set the relay, internal switch, or HOLD profile trend to Off.

Note

Do not manually operate a relay assigned to a status event or the output status of an internal switch action.

Number

Set the target number for Message, Reset the relative timer, Event trigger, Save event data, Flag, User function key, Load program pattern, Load profile trend, or Load predictive detection model.

Operation mode	Type	Setup Items
Rising edge, Falling edge, Edge	Flag	Flag number 1 to 20
	Relay	DO channel whose Type is set to Manual
	Save event data	Measurement group 1
	Event trigger	Measurement group 1, measurement group 2*
	Message	Message number 1 to 100
	Reset the relative timer	Timer number 1 to 4 (relative time)
	Load settings	Load number 1 to 10
	Save settings	Save number: 1 to 10
	Internal switch	Internal switch number whose Type is set to Manual
	Load program pattern*	File number 1 to 10
	Load profile trend	Load number 1 to 50
	Load predictive detection model	Load number 1 to 50
	Rising / Falling edge	Flag On/Off
Relay On/Off		DO channel whose Type is set to Manual
Internal switch On/Off		Internal switch number whose Type is set to Manual

* When the measurement mode is set to Dual interval Release number 4 and later.

Group number

Set the display group number to write the message to when **Specified group** is specified.

Batch group number

Set the batch group number or all batch groups (ALL) to execute when events occur.

Explanation

Resetting a Relative Timer

Resets a timer and starts it.

If you reset a relative timer, it is considered to have expired (if the timer is being used as an event, the corresponding action is executed).

Resetting a Match Time Timer

Resets a match time timer after it expires so that it is enabled again.

- Resetting a match time timer is not considered a timeout (even if it is being used as an event in the event action function, the corresponding action is not executed).
- This operation can be used with match time timers whose timer action is set to single.

Loading Setting Parameters

This action can be specified only when the event is set to remote or user function key.

This action loads a setting parameter file from the root directory of the SD card and configures the GM accordingly. Setting parameter files are named "LOAD1.GNL," "LOAD2.GNL," and so on up to "LOAD10.GNL." (If the advanced security function is enabled (On), the extension is .GSL.)

You must create a setting parameter file and save it to the SD card in advance.

If the advanced security function (/AS option) is in use, security settings are not loaded.

Loading Profile Trend

This action can be specified only when the event is set to remote or user function key.

A "Profile" folder must be created in the root directory of the SD card in advance and files with the names "Profile1.GPF," "Profile2.GPF," and so on up to "Profile50.GPF" must be saved.

- If the profile waveform is loaded during the early warning detection interval, the profile waveform reading and the determination of the profile alarm are stopped.

Loading Predictive Detection Model

This action can be specified only when the event is set to remote or user function key. A "Model" folder must be created in the root directory of the SD card in advance and files with the names "Model1.GPF," "Model2.GPF," and so on up to "Model50.GPF" must be saved.

Saving Setting Parameters

This action can be specified only when the event is set to remote or user function key. This action saves a setting parameter file with the name "SAVE1.GNL," "SAVE2.GNL," and so on up to "SAVE10.GNL" in the root directory of the SD card. (If the advanced security function is enabled (On), the extension is .GSL.)

Time Adjustment

This action can be specified only when the event is set to remote control input. This action sets the GM internal clock to the nearest hour.

- **Operation When Recording Is Stopped**

Difference from the Nearest Hour	Operation
00 min 00 s to 01 min to 59 s	Truncates the minutes and seconds. Example: 10 hours 01 min 50 s becomes 10 hours 00 min 00 s.
02 min 00 s to 57 min to 59 s	The time is not changed.
58 min 00 s to 59 min to 59 s	Rounds up the minutes and seconds. Example: 10 hours 59 min 50 s becomes 11 hours 00 min 00 s.

- **Operation during Recording**

If the time difference between the event occurrence time and the nearest hour is within the time specified by **Gradually adjusting the time** of **Time basic settings**, the time is gradually corrected. Otherwise, the time is corrected according to **Time adjustment beyond limit**.

▶ See the explanation in page 2-182 in section 2.26.4, "Setting the Time Zone, Gradual Time Adjustment, and Daylight Saving Time".

Internal Switch and Relay Output When the Scan Interval Is Shorter Than 100 ms

Internal switches and relays triggered by event actions are output at 100 ms intervals.

Limitations on the Combinations of Events and Actions

The combinations that are indicated with ✓ marks in the table below can be used.

Action \ Event	Remote (DI) ³	Relay (DO)	Internal switch	Alarm - IO channel	Alarm - Math channel	Alarm - Communication channel	Any alarm	Health score notification	Timer	Match timer	User function key	Status
Recording	✓	✓	✓	✓	✓	✓	✓	✓	✓	✓	✓	
Recording start/stop ¹	✓	✓	✓	✓	✓	✓	✓					
Computation	✓	✓	✓	✓	✓	✓	✓	✓	✓	✓	✓	
Computation start/stop ¹	✓	✓	✓	✓	✓	✓	✓					
Manual sample	✓	✓	✓	✓	✓	✓	✓	✓	✓	✓	✓	
Alarm ACK	✓								✓	✓	✓	
Save display data	✓	✓	✓	✓	✓	✓	✓	✓	✓	✓	✓	
Save event data	✓	✓	✓	✓	✓	✓	✓	✓	✓	✓	✓	
Event trigger	✓	✓	✓	✓	✓	✓	✓		✓	✓	✓	
Message	✓	✓	✓	✓	✓	✓	✓	✓	✓	✓	✓	✓
Reset the relative timer	✓	✓	✓	✓	✓	✓	✓			✓	✓	
Load settings	✓										✓	
Save settings	✓										✓	
Load program pattern	✓										✓	
Adjust the time	✓											
Flag	✓	✓	✓	✓	✓	✓	✓	✓	✓	✓	✓	✓
Flag On/Off ¹	✓	✓	✓	✓	✓	✓	✓					✓
Relay output ²	✓		✓					✓	✓	✓	✓	✓
Relay On/Off ^{1,2}	✓		✓									✓
Internal switch ²	✓	✓						✓	✓	✓	✓	✓
Internal switch On/Off ^{1,3}	✓	✓										✓
Load profile trend	✓										✓	
Load predictive detection model	✓										✓	
Predictive detection section	✓	✓	✓	✓	✓	✓	✓		✓	✓	✓	
HOLD profile trend	✓	✓	✓	✓	✓	✓	✓		✓	✓	✓	
Predictive detection section start/stop ¹	✓	✓	✓	✓	✓	✓	✓					
HOLD profile trend On/Off ¹	✓	✓	✓	✓	✓	✓	✓					

- 1 When the operation mode is Rising/Falling edge.
- 2 Action can be set to Relay output, Relay On/Off, Internal switch, or Internal switch On/Off only when the DO channel range type and internal switch type is set to Manual.
- 3 Only for DI modules installed in the GM whose operation mode is set to Remote.

2.20.2 Event Action Examples

Example 1: Starting/Stopping Recording through Remote Control

Starts or stops recording when a remote control signal is applied to DI channel 0101. We assume that a DI module is installed in slot 1 of the main unit and that the operation mode is set to Remote. Event action number 1 will be used.

Setting the Mode of the DI Module

- **Procedure**

Config. tab > Measurement settings > Module settings > Module code "GX90XD-16-11N"

- **Setup Items**

Setup Item	Value
Operation mode	Remote

Configuring the Event Action

- **Procedure**

Config. tab > Event action > Event action number [1-20]

- **Setup Items**

Setup Item	Value
Event action number	1
Event action	On/Off
Event	Type
	Number
	Operation mode
Action	Type

Operation

If the DI channel 0101 input is turned on when recording is stopped, recording starts. If the DI channel 0101 input is turned off when recording is in progress, recording stops.

Example 2: Writing a Message When an Alarm Occurs

Write the message "Channel 1 Alarm" to group 1 when an alarm occurs on channel 0001. This example assumes that an AI module is installed in slot 0 of the GM main unit. Use event action number 2.

Configuring the Event Action

- **Procedure**

Config. tab > Event action > Event action number [1-20]

- **Setup Items**

Setup Item	Value
Event action number	2
Event action	On/Off
Event	Type
	Number
	Detail
	Operation mode
Action	Type
	Number

Other Settings

- Set AI channel 0001 to alarm level 1.
 - ▶ Setup: See page 2-32 in section 2.3.2, "Setting Alarms".
- Register "Channel 1 Alarm" in message number 1.
 - ▶ Setup: See page 2-96 in section 2.11.3, "Setting Messages".

Example 3: Saving the Data Every Day at Hour 17

Save recorded data to the SD card every day at hour 17. Use event action number 3. Use match time timer number 1.

Setting Match Time Timer 1

- **Procedure**
 Config. tab **Timer settings** > **Match time timer**
- **Setup Items**

Setup Item	Value	
Match time timer	1	
Type	Day	
Timer match condition	Hour	17
	Minute	00
Timer action	Timer action	Repeat

Configuring the Event Action

- **Procedure**
 Config. tab > **Event action** > **Event action number** [1-20]
- **Setup Items**

Setup Item	Value	
Event action number	3	
Event action	On/Off	On
Event	Type	Match time timer
	No.	1
	Operation mode	Edge
Action	Type	Save display data

Other Settings

Set the display data to be saved automatically. Set the file save interval to **1day** or longer. If a file save interval shorter than **1day** is specified, the data is also saved at the file save interval.

- ▶ Setup: page 2-104 in section 2.13.1, "Setting the Type of Data to Record (Event or display data) and Recording Conditions"
- ▶ Setup: page 2-118 in section 2.15.2, "Setting the Save Method to Media (Auto save or manual save) and Media FIFO"

Example 4: Setting DO to OFF and When Recording Starts and DO to ON When Recording Stops

Set the output status of DO channel 0009 to ON when recording stops and OFF when recording starts.

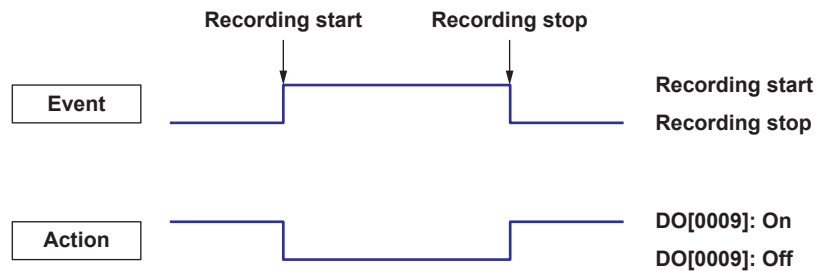

This example assumes that a DI/DO module is installed in slot 0 of the GM main unit. Use event action numbers 4 and 5.

Setting the DO Channel Type

- **Procedure**
Config. tab > DO channel settings > [0009-0014] > Range
- **Setup Items**

Setup Item	Value
CH (channel)	0009
Range	Type Manual

Configuring the Event Action

- **Procedure**
Config. tab > Event action > Event action number [1-20]
- **Setup Items**

Setup Item	Value
Event action number	4
Event action	On/Off On
Event	Type Status
	Detail Record
	Operation mode Rising edge
Action	Type Relay
	No. 0009
	Detail Off

Setup Item	Value
Event action number	5
Event action	On/Off On
Event	Type Status
	Detail Record
	Operation mode Falling edge
Action	Type Relay
	No. 0009
	Detail On

2.21 Configuring Communication Channels (/MC option)

Set communication channels.

Set these items to make the GM record data from Modbus devices or PCs.

2.21.1 Enabling Communication Channels and Setting the Span, Decimal Point, and Unit

Path

Web application: **Config.** tab > **Communication channel settings** > **Channel range**
(display example: C001-C020) > **On/Off, Span**

Hardware configurator: **Communication channel settings** > **Channel range** (display example: C001-C020) > **On/Off, Span**

Description

Item	Selectable Range or Options	Default Value
Channel range	GM10-1: C001 to C300 GM10-2: C001 to C500	—

On/Off, Decimal place, Span Lower, Span Upper, Unit

Setup Item	Selectable Range or Options	Default Value
On/Off	Off, On	Off
Decimal place*	0, 1, 2, 3, 4, 5	0
Span Lower*	–9999999 to 99999999	0
Span Upper*	–99999999 to 999999999	100
Unit*	Character string (up to 6 characters, A a# 1)	—

* You can set this when a communication channel is set to **On**.

On/Off

Select **On** to use the communication channels.

Decimal place

Set the decimal place for span lower and span upper.

Span Lower, Span Upper

Set the input range.

Unit

Set the unit.

At Power on*

Setup Item	Selectable Range or Options	Default Value
Value at power on	Last value, Preset value	Last value

* You can set this when On/Off is set to **On**.

Value at power on

Set the value to replace the communication channel value at power-on.

Preset value*

Setup Item	Selectable Range or Options	Default Value
Preset value	-9.999999E+29 to 9.999999E+29 -9.999999E+29 to -1.000000E-30,0, 1.000000E-30 to 9.999999E+29	0

* You can set this when On/Off is set to **On**.

Preset value

Set the preset value.

Watchdog timer

Setup Item	Selectable Range or Options	Default Value
On/Off	Off, On	Off
Timer*	1 to 120 (s)	30
Value at timer-expired*	Last value, Preset value	Last value

* You can set this when the watchdog timer is set to **On**.

On/Off

Set this to **On** to use the watchdog timer.

Timer

Set the duration for monitoring values that fail to be updated.

If a value is not updated within the specified duration, the value is replaced.

Value at timer-expired

Set whether to set the value when the timer expires to the last value or preset value.

Explanation**Watchdog Timer Function**

Data may fail to be updated due to Modbus or other communication problems. The watchdog timer function replaces values with preset values or last values when values are not updated within the specified duration (timer).

Data replacement occurs immediately when the timer expires, and the values are held until the next read cycle.

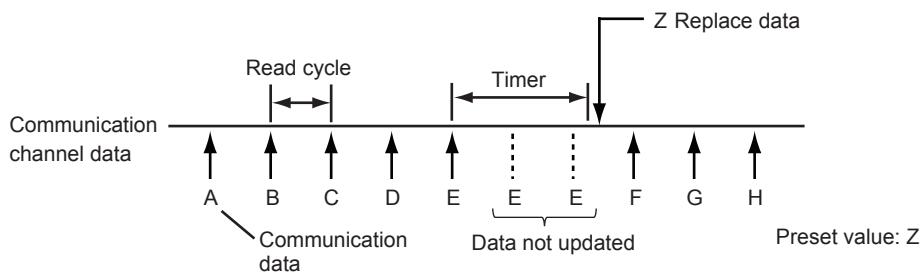

2.21.2 Setting Alarms

Path

Web application: **Config.** tab > **Communication channel settings** > **Channel range**
(display example: C001-C020) > **Alarm**

Hardware configurator: **Setting** tab > **Communication channel settings** > **Channel range**
(display example: C001-C020) > **Alarm**

Description

Setup Item	Selectable Range or Options	Default Value
Channel range	GM10-1: C001 to C300 GM10-2: C001 to C500	—

Level 1, Level 2, Level 3, Level 4

Setup Item	Selectable Range or Options	Default Value
On/Off	Off, On	Off
Type ¹	H: High limit, L: Low limit, T: Delay high limit, t: Delay low limit, F: Profile high limit ⁴ , f: Profile low limit ⁴	H: High limit
Value ^{1,5}	–9999999 to 99999999	0
Hysteresis ^{1,3,5}	Numeric value (0 to 100000)	0
Logging ¹	On/Off	On
Output type ¹	Off, Relay, Internal switch	Off
Output No. ²	DO channel or internal switch	—

1 You can set this when a level (1 to 4) is set to **On**.

2 You can set this when Output type is not set to **Off**.

3 You can set this when the type is set to **H:High limit** or **L:Low limit**.

4 Release number 5 and later. The profile trend setting can be configured when **On**.

5 You cannot set this when the type is set to profile high limit or profile low limit.

On/Off

Set this to **On** to set alarms.

Type

Set the alarm type.

Value

Set the alarm value for the specified alarm type.

Options	Value
H, L	Within –9999999 to 99999999 excluding the decimal point.
T, t	Same as H and L

Hysteresis

Set this to establish an offset between the value used to activate and release alarms.

Logging

Set this **On** to display an alarm (notify you) when an alarm occurs. If set to **Off**, when an alarm occurs, the GM outputs signals to alarm output DO channels or internal switches but does not display the alarm. Alarms are also not recorded in the alarm summary.

Output type

Set the alarm output destination.

Output No.

Set the number of the DO channel or internal switch to output alarms to.

Profile channel (Release number 5 and later) *

Setup Item	Selectable Range or Options	Default Value
High limit	Off, Communication channel	Off
Reference	Same as High limit	Off
Low limit	Same as High limit	Off

* You can set this when the communication channel function (/MC option) is included.

High limit

Sets the communication channel through which the high limit data of the profile trend is loaded.

Reference

Sets the communication channel through which the reference data of the profile trend is loaded.

Lower limit

Set the communication channel through which the low limit data of the profile trend is loaded.

Note

- You must load the profile trend in advance to read the trend data.
- Set the profile channel to the same channel as the channel number of the loaded profile trend.
- You can only set this when On/Off is set to the On communication channel.

Alarm delay (for delay high/low limit alarms) *

Setup Item	Selectable Range or Options	Default Value
Hour	1 to 24	0
Minute	0 to 59	0
Second	0 to 59	10

* You can set this when Level 1, Level 2, Level 3, or Level 4 is **On**.

Hour, Minute, and Second

Set the alarm delay. These values are valid when the delay high limit or delay low limit is in use.

► For details on alarm types, see page 2-32 in section 2.3.2, "Setting Alarms".

2.21.3 Setting the Display**Path**

Web application: **Config.** tab > **Communication channel settings** > **Channel range**
(display example: C001-C020) > **Display settings**

Hardware configurator: **Communication channel settings** > **Channel range** (display example: C001-C020) > **Display settings**

Description**Tag**

Setup Item	Selectable Range or Options	Default Value
Characters	Character string (up to 32 characters, Aa#1)	—
No.	Character string (up to 16 characters, Aa#1)	—

Characters

Set the tag.

Not all characters may be displayed due to space constraints.

No.

Set the tag number.

Color

Setup Item	Selectable Range or Options	Default Value
Color	24 colors (red, green, blue, blue violet, brown, orange, yellow-green, light blue, violet, gray, lime, cyan, dark blue, yellow, light gray, purple, black, pink, light brown, light green, dark gray, olive, dark cyan, and spring green) and a user-defined color (1 color)	—

Color

Set channel display colors. The colors apply to the trend display and bar graph display.

- ▶ For instructions on how to set the user-defined color, see “Operation Example 2” on page 2-13.

Zone

Setup Item	Selectable Range or Options	Default Value
Lower	0 to 95%	0
Upper	5 to 100% input	100

Lower and Upper

Set these values when you want to divide the waveform displays of channels into separate zones so that waveforms do not overlap. Set the **Lower** and **Upper** positions as percentages of the maximum display width. Set **Lower** to a value less than **Upper**, and set the zone width (**Upper – Lower**) to be 5% or greater.

- ▶ For zone display examples, see “Changing the Trend’s Waveform Display” on page 3-16.

Bar graph

Setup Item	Selectable Range or Options	Default Value
Base position	Lower, Center, Upper	Lower

Base position

Set the bar graph base position.
This setting is applied on the bar graph display.

- ▶ For bar graph display examples, see “Bar Graph Monitor and Horizontal Bar Graph Monitor” on page 3-22.

Color scale band

Setup Item	Selectable Range or Options	Default Value
Band area	Off, In, Out	Off
Color	24 colors (red, green, blue, blue violet, brown, orange, — yellow-green, light blue, violet, gray, lime, cyan, dark blue, yellow, light gray, purple, black, pink, light brown, light green, dark gray, olive, dark cyan, and spring green) and a user-defined color (1 color)	
Display position Lower	Span (scale) lower limit to span (scale) upper limit	0.00
Display position Upper	Span (scale) lower limit to span (scale) upper limit	1.00

Band area

Displays a specified section of the measurement range using a color band on the scale. This setting is shared with the bar graph display.

Options	Description
Off	Disables the function.
In	Displays the area inside using the color band.
Out	Displays the area outside using the color band.

Color

Set the display color.

Upper display position limit, Lower display position limit

Set the display position. Set a value within the span range.

Alarm point mark



Setup Item	Selectable Range or Options	Default Value
Indicate on Scale	Off, On	On
Mark kind	Alarm, Fixed	Alarm
Alarm 1 color to Alarm 4 color*	24 colors (red, green, blue, blue violet, brown, orange, yellow-green, light blue, violet, gray, lime, cyan, dark blue, yellow, light gray, purple, black, pink, light brown, light green, dark gray, olive, dark cyan, and spring green) and a user-defined color (1 color)	

* You can set this when the Mark kind is set to **Fixed**.

Indicate on Scale

Set this to **On** to display alarm point marks on the scale. Set this to **Off** to not display them. This setting is shared with the bar graph display.

Mark kind

Options	Description	Mark Shape
Alarm	Displayed normally in green. Displayed in the specified color when an alarm occurs.	 or 
Fixed	Displayed with a fixed color.	

Alarm 1 color to Alarm 4 color

When Mark kind is set to **Fixed**, set the display colors of point marks for alarm levels 1 to 4.

2.21.4 Setting Calibration Correction (Linearizer approximation, linearizer bias, Correction factor* (release number 4 (version 4.02) and later))

* /AH option only

Path

Web application: **Config.** tab > **AI channel settings** or **AI (mA) channel settings** > Channel range (display example: 0001-0010) > **Calibration correction**
 Hardware configurator: **AI channel settings** or **AI (mA) channel settings** > Channel range (display example: 0001-0010) > **Calibration correction**

Description

Calibration correction

Setup Item	Selectable Range or Options	Default Value
On/Off	Off/On ²	Off
Mode ¹	Linearizer Approximation, Linearizer Bias, Correction Factor	Linearizer Approximation
Number of set points ¹	2 to 12	2
Edit correction points ¹	Use the Edit correction points button to display a — calibration correction dialog box.	—

¹ You can set this when On/Off is set to **On**.

² This setting is fixed to Off when communication channel is not used (Off (page 2-146)).

On/Off

Set the communication channel for the calibration correction to On*.

* The number of channels that can be set to On has the following limitations.

Model	Number of channels that can be set to On
GM10-1	150
GM10-2	300

Mode

Set the correction mode when performing calibration correction.

When the range is set to DI or Skip, the mode is fixed to Off.

Number of set points

Set the number of points that make up the segments (including the start and end points).

Edit correction points: Linearizer approximation or linearizer bias (1 to 12*)

Setup Item	Selectable Range or Options	Default Value
Linearizer input	-9999999 to 9999999	—
Linearizer output	-9999999 to 9999999	—

* The number of displayed points varies depending on the number of set points.

Linearizer input, Linearizer output

Enter the value of the set point. For linearizer input, set a value that is greater than the previous value.

Edit correction points: Correction factor (1 to 12*) (/AH option only)

Setup Item	Selectable Range or Options	Default Value
Uncorrected value	-9999999 to 9999999	—
Instrument correction factor	-9999999 to 9999999	—
Sensor correction factor	-9999999 to 9999999	—
Execution of the input measurement	—	—

* The number of displayed points varies depending on the number of set points.

Uncorrected value

Enter the uncorrected value. Set a value that is greater than the previous value.

Instrument correction factor

Set the instrument-dependent correction factor.

Sensor correction factor

Set the sensor-dependent correction factor.

Procedure

Click Linearizer **Edit correction points** to display the AI channel[XXXX] Calibration correction dialog box.

Linearizer approximation, linearizer bias

Linearizer input/output	Linearizer input	Linearizer output
1	-99999.99	-99999.99
2	0.01	0.01
3	100000.01	100000.01
4	200000.00	200000.00
5	300000.00	300000.00
6	400000.00	400000.00
7	500000.00	500000.00
8	600000.00	600000.00
9	700000.00	700000.00
10	799999.99	799999.99
11	899999.99	899999.99
12	999999.99	999999.99

Correction factor

Correction point	Uncorrected value	Instrument correction factor	Sensor correction factor
1	-99999.99	0.00	0.00
2	0.01	0.00	0.00
3	100000.01	0.00	0.00
4	200000.00	0.00	0.00
5	300000.00	0.00	0.00
6	400000.00	0.00	0.00
7	500000.00	0.00	0.00
8	600000.00	0.00	0.00
9	700000.00	0.00	0.00
10	799999.99	0.00	0.00
11	899999.99	0.00	0.00
12	999999.99	0.00	0.00

Explanation

Linearizer Approximation

Corrects input values using characteristics specified with segments to derive output values.

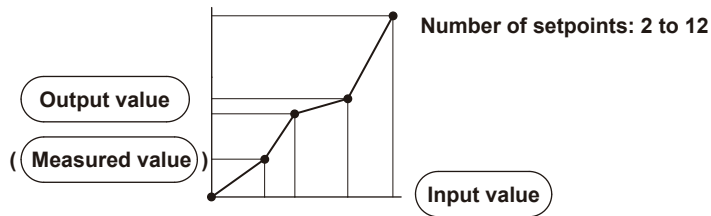

Linearizer Bias

Corrects input values using bias values specified with segments to derive output values.

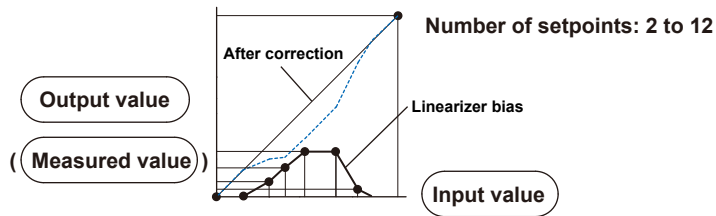

Correction Factor

Corrects input values using the instrument correction factor and sensor correction factor specified with segments to derive output values.

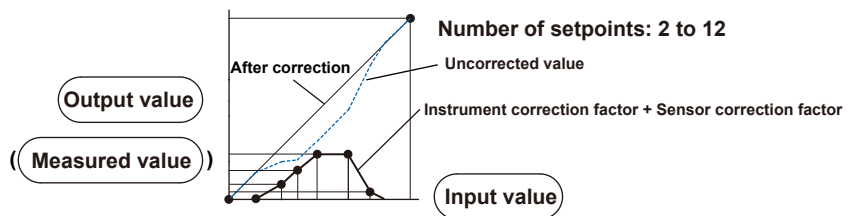

2.22 Configuring the Ethernet Communication Function

Set the Ethernet communication conditions.

- ▶ For the WT connection client settings (WT communication (/E2 option)), see the WT Communication (/E2) User's Manual (IM 04L51B-19EN).
- ▶ For the EtherNet/IP communication settings (EtherNet/IP communication (/E1 option)), see the EtherNet/IP Communication (/E1) User's Manual (IM 04L51B-18EN).
- ▶ For the SLMP client settings (SLMP communication (/E4 option)), see the SLMP Communication (/E4) User's Manual (IM 04L51B-21EN).

2.22.1 Setting Basic Communication Conditions

Path

Web application: **Config. tab > Communication (Ethernet) settings > Communication (Ethernet) Basic settings**

Hardware configurator: **Communication (Ethernet) settings > Ethernet basic settings**

Description

Automatic IP settings

Setup Item	Selectable Range or Options	Default Value
Obtain IP address automatically	Off, On	Off

Obtain IP address automatically

Set this to **On** to automatically obtain the IP address (DHCP).

- If the current connection is disconnected after obtaining the IP address automatically, you can check the IP address with the IP Address Configurator (▶ see page 2-2 in section 2.1.2, "Setting the IP Address (IP Address Configurator)").
After reconnection, you can check the IP address on the network information monitor (▶ see "Network Information Monitor" on page 3-37).

IP address

Setup Item	Selectable Range or Options	Default Value
IP address	0.0.0.0 to 255.255.255.255	0.0.0.0
Subnet mask	0.0.0.0 to 255.255.255.255	0.0.0.0
Default gateway	0.0.0.0 to 255.255.255.255	0.0.0.0

* You can set this when Obtain IP address automatically is set to **Off**.

IP address

Set a fixed IP address to assign to the GM.

Subnet mask

Set the subnet mask. Set this in accordance with the system or network that the GM belongs to.

Default gateway

Set the IP address of the default gateway.

Automatic DNS settings*

Setup Item	Selectable Range or Options	Default Value
Obtain DNS address automatically	Off, On	Off

* You can set this when Obtain IP address automatically is set to **On**.

Obtain DNS address automatically

Set this to **On** to automatically obtain the DNS server address. Otherwise, set this to **Off**. If you set this to **Off**, you need to set the primary and secondary DNS servers and domain suffixes.

You can check the DNS server address that was obtained automatically (▶see “Network Information Monitor” on page 3-37).

DNS settings*

Setup Item	Selectable Range or Options	Default Value
Primary DNS server	0.0.0.0 to 255.255.255.255	0.0.0.0
Secondary DNS server	0.0.0.0 to 255.255.255.255	0.0.0.0

* You can set this when Obtain DNS address automatically is set to **Off**.

Primary DNS server

Set the IP address of the primary DNS server.

Secondary DNS server

Set the IP address of the secondary DNS server.

Domain suffix

Setup Item	Selectable Range or Options	Default Value
Primary domain suffix	Character string (up to 64 characters, Aa#1)	—
Secondary domain suffix	Character string (up to 64 characters, Aa#1)	—

Primary domain suffix

Set the primary domain name. You do not have to set this.

Secondary domain suffix

Set the secondary domain name. You do not have to set this.

Host settings

Setup Item	Selectable Range or Options	Default Value
Host name	Character string (up to 64 characters, Aa#1)	—
Domain name	Character string (up to 64 characters, Aa#1)	—

Host name

Set the GM host name.

Domain name

Set the domain name of the network that the GM belongs to. This is valid when Obtain DNS address automatically is set to **Off**.

Host name registration*

Setup Item	Selectable Range or Options	Default Value
Host name registration	Off, On	Off

* You can set this when Obtain IP address automatically is set to **On**.

Host name registration

Set this to **On** to register the host name.

Note

For information on IP address, subnet mask, default gateway, DNS, and other settings, check with your network administrator.

If the communication is disconnected due to a change in the IP address, do not close the browser, refresh the Web browser, or change the URL until the communication status icon turns off.

Doing so may cause the closing of the browser or refreshing of the Web page to take a long time.

► For details on the communication status icon, see “Status Indications” on page 2-7.

2.22.2 Configuring the FTP Client Function

Path

Web application: **Config. tab > Communication (Ethernet) settings > FTP client settings**
 Hardware configurator: **Communication (Ethernet) settings > FTP client settings**

Description

FTP client function

Setup Item	Selectable Range or Options	Default Value
On/Off	Off, On	Off

On/Off

Select **On** to use the FTP client function.

Transfer file¹

Setup Item	Selectable Range or Options	Default Value
Display & Event data	Off, On	Off
Report	Off, On	Off
Manual sampled data	Off, On	Off
Alarm summary	Off, On	Off
Setting file ²	Off, On	Off
Health monitor ³	Off, On	Off

¹ You can set this when the FTP client function is set to **On**.

² You can set this when you are using the advanced security function (/AS option).

³ Release number 5 and later.

Display & Event data

Set this to **On** to automatically transfer display and event data files.

Report

Set this to **On** to automatically transfer report data files (including those based on report templates).

Manual sampled data

Set this to **On** to automatically transfer manual sampled data.

Alarm summary

Set this to **On** to automatically transfer alarm summaries.

Setting file (for the advanced security function (/AS option))

Set this to **On** to automatically transfer the setting parameter file when settings are changed. The files saved to the SD memory card are also automatically transferred when the profile trend is loaded.

Health monitor

Set this to **On** to automatically transfer health monitor files.

Transfer wait time^{*}

Setup Item	Selectable Range or Options	Default Value
Display & Event data	0 to 120 (minute)	0
Report	0 to 120 (minute)	0

^{*} You can set this when the FTP client function is set to **On**.

Display & Event data

Set the time to delay the data transfer to the FTP server.

Report

Set the time to delay the data transfer to the FTP server.

Encryption*

Setup Item	Selectable Range or Options	Default Value
Encryption	Off, On	Off
Verification of certificate	Off, On	On

* You can set this when the FTP client function is set to **On**.

Encryption

Set to **On** to encrypt using SSL the data transferred via FTP.

Verification of Certificate

Set to **On** to verify the certificate received from the server using the certificate installed in the GM.

FTP connection Primary*

Setup Item	Selectable Range or Options	Default Value
FTP server name	Character string (up to 64 characters, Aa#1)	—
Port number	Numeric value (1 to 65535)	21
User name	Character string (up to 32 characters, Aa#1)	—
Password	Character string (up to 32 characters, Aa#1)	—
Directory	Character string (up to 64 characters, Aa#1)	—
PASV mode	Off, On	Off

* You can set this when the FTP client function is set to **On**.

FTP server name

Set the name of the FTP server to transfer files to.

If the DNS is available, you can set the host name as a server name.

You can also set the IP address. In this case, the DNS is not required.

- For details on DNS, see page 2-154 in section 2.22.1, "Setting Basic Communication Conditions".

Port number

Set the port number of the FTP server to transfer files to.

User name

Set the user name (login name) for accessing the FTP server.

Password

Set the password for accessing the FTP server.

Directory

Set the directory of the file transfer destination. The delimiter for directories varies depending on the implementation of the destination FTP server.

Example: When transferring files to the "data" directory in the "home" directory of an FTP server on a UNIX file system.

/home/data

PASV mode

Set this to **On** when using the GM behind a firewall that requires the PASV mode.

FTP connection Secondary

Configure the secondary FTP server. The settings are the same as those for "FTP connection Primary."

2.22.3 Configuring the SMTP Client Function

Path

Web application: **Config. tab > Communication (Ethernet) settings > SMTP client settings**

Hardware configurator: **Communication (Ethernet) settings > SMTP client settings**

Description

SMTP client function

Setup Item	Selectable Range or Options	Default Value
On/Off	Off, On	Off

On/Off

Select **On** to use the SMTP client function.

Authentication*

Setup Item	Selectable Range or Options	Default Value
Authentication	Off, SMTP Authentication, POP before SMTP, APOP	Off

* You can set this when the SMTP client function is set to **On**.

Authentication

Set the authentication method for authenticated e-mail transmission.

Encryption*

Setup Item	Selectable Range or Options	Default Value
Encryption	Off, On	Off
Verification of certificate	Off, On	On

* You can set this when authentication is set to **Off** or **SMTP Authentication**.

Encryption

Set to On to encrypt using SSL the data transferred via SMTP.

Verification of Certificate

Set to On to verify the certificate received from the server using the certificate installed in the GM.

SMTP server¹

Setup Item	Selectable Range or Options	Default Value
SMTP server name	Character string (up to 64 characters, Aa#1)	—
Port number	Numeric value (1 to 65535)	25
User name ²	Character string (up to 32 characters, Aa#1)	—
Password ²	Character string (up to 32 characters, Aa#1)	—

¹ You can set this when the SMTP client function is set to **On**.

² You can set this when authentication is set to **SMTP Authentication**.

SMTP server name

Set the host name or IP address of the SMTP server.

Port number

Set the port number to use. Unless specified otherwise, you do not need to change this number.

User name

Set the login name for accessing the server using SMTP authentication.

Password

Set the password for accessing the server using SMTP authentication.

POP3 Server¹

Setup Item	Selectable Range or Options	Default Value
POP3 server name	Character string (up to 64 characters, Aa#1)	—
Port number	Numeric value (0 to 65535)	110
User name ²	Character string (up to 32 characters, Aa#1)	—
Password ²	Character string (up to 32 characters, Aa#1)	—

¹ You can set this when the SMTP client function is set to **On**.

² You can set this when authentication is set to **POP Before SMTP** or **APOP**.

POP3 server name

If you need to use POP before SMTP, set the host name or IP address of the POP3 server.

Port number

Set the port number to use. Unless specified otherwise, you do not need to change this number.

User name

Set the login name for accessing the POP3 server.

Password

Set the login password for accessing the POP3 server.

2.22.4 Setting E-mail Transmission Conditions (When the SMTP client function is on)

Set the server configuration and the contents of the e-mail transmission.

► For the mail format, see page 3-45 in section 3.2.5, "E-mail Format".

Path

Web application: **Config**. tab > **Communication (Ethernet) settings** > **E-mail settings**

Hardware configurator: **Communication (Ethernet) settings** > **E-mail settings**

Description**Mail header**

Setup Item	Selectable Range or Options	Default Value
Recipient 1	Character string (up to 150 characters, Aa#1)	—
Recipient 2	Character string (up to 150 characters, Aa#1)	—
Sender	Character string (up to 64 characters, Aa#1)	—
Subject	Character string (up to 32 characters, Aa#1)	—

Recipient 1

Set the address of recipient 1. You can enter multiple e-mail address in a recipient box. When entering multiple addresses, delimit each address with a space.

Recipient 2

Set the address of recipient 2. You can enter multiple e-mail address in a recipient box. When entering multiple addresses, delimit each address with a space.

Sender

Set the sender address. Set this if necessary.

Subject

Set the subject of e-mails.

E-mail contents

Setup Item	Selectable Range or Options	Default Value
Header	Character string (up to 128 characters, Aa#1)	—
Include source URL	Off, On	Off

Header

Set the mail header.

Include source URL

Set this to **On** to include the source URL. The URL is attached when the Web server is enabled.

Alarm settings

Setup Item	Selectable Range or Options	Default Value
Alarm notification	Off, Recipient 1, Recipient 2, Recipient 1 & Recipient 2	Off
Detection ¹	Channel, Alarm level	Channel
Channel set ²	Up to 50 channels; I/O channels, Math channels, communication channels	—
Alarm level 1 ³	Off, On	Off
Alarm level 2 ³	Off, On	Off
Alarm level 3 ³	Off, On	Off
Alarm level 4 ³	Off, On	Off
Attach instantaneous data*	Off, On	Off
Send alarm action*	Occurrence & Release, Occurrence	Occurrence & Release
Include tag/ch in Subject	Off, On	Off

- 1 You can set this when the alarm notification is not set to **Off**.
- 2 You can set this when the Detection is set to Channel.
- 3 You can set this when the Detection is set to Alarm level.

- Alarm notification mail is not sent when a control alarm occurs or is released.

Alarm notification

Set the recipients that will receive e-mails when alarms occur and are released.

Detection

Set the type for detecting alarm occurrence and release.
You cannot specify a channel of an AO module or PID control module.

Channel set

Set the source channel for detecting alarm occurrence and release.

Alarm level 1 to Alarm level 4

Set the alarm level for detecting alarm occurrence and release.
The setting applies to all channels.

Attach instantaneous data

Set this to **On** to include instantaneous data. The data that is attached is the instantaneous value at the time an e-mail is transmitted.

Send alarm action

Set the type of alarm notification mail to transmit.

Include tag/ch in Subject

Set this to **On** to include the channel number and tag of the alarm detection channel in the subject.

Report settings

Setup Item	Selectable Range or Options	Default Value
Report notification	Off, Recipient 1, Recipient 2, Recipient 1 & Recipient 2	Off

Report notification

Set the recipients that will receive report e-mails.

Scheduled settings

Setup Item	Selectable Range or Options	Default Value
Scheduled notification	Off, Recipient 1, Recipient 2, Recipient 1 & Recipient 2	Off
Attach instantaneous data*	Off, On	Off
Interval (Recipient 1)	1h/2h/3h/4h/6h/8h/12h/24h	24h
Ref. time hour (Recipient 1)	0 to 23	0
Ref. time minute (Recipient 1)	0 to 59	0
Interval (Recipient 2)	1h/2h/3h/4h/6h/8h/12h/24h	24h
Ref. time hour (Recipient 2)	0 to 23	0
Ref. time minute (Recipient 2)	0 to 59	0

* You can set this when Scheduled notification is not set to **Off**.

Scheduled notification

Set the recipients that will receive scheduled e-mail transmissions.

Attach instantaneous data

Set this to **On** to include instantaneous data. The data that is attached is the instantaneous value at the scheduled times.

Interval (Recipient 1)

Set the interval for transmitting e-mails to recipient 1.

Ref. time hour, Ref. time minute (Recipient 1)

Set the time used as a reference for sending e-mails at specific intervals to Recipient 1.

Interval (Recipient 2)

Set the interval for transmitting e-mails to recipient 2.

Ref. time hour, Ref. time minute (Recipient 2)

Set the time used as a reference for sending e-mails at specific intervals to Recipient 2.

System settings

Setup Item	Selectable Range or Options	Default Value
Memory full notification	Off, Recipient 1, Recipient 2, Recipient 1 & Recipient 2	Off
Power failure notification	Off, Recipient 1, Recipient 2, Recipient 1 & Recipient 2	Off
System error notification	Off, Recipient 1, Recipient 2, Recipient 1 & Recipient 2	Off
User lockout notification ¹	Off, Recipient 1, Recipient 2, Recipient 1 & Recipient 2	Off
Health score notification ²	Off, Recipient 1, Recipient 2, Recipient 1 & Recipient 2	Off

¹ You can set this when you are using the advanced security function (/AS option).

² Release number 5 and later.

Memory full notification

Sends a message when the free space on the external storage medium or internal memory is low.

Power failure notification

Set recipients if you want e-mails to be sent when the GM is powered on or recovers from a power failure.

System error notification

Set recipients if you want e-mails to be sent when system errors occur.

Health score notifications

Set the recipients that will receive health score notification email transmissions.

Transmission email type

Health score	Email type
Early notification threshold or less	Early notification
Less than 0	NG notification *

* If the health score is less than 0, whether the early warning notification function is [On] or [Off], an "NG notification" email is sent. "NG" means Not Good.

► For the early notification, see page 3-45 in section 3.2.5, "E-mail Format".

User lockout notification (for the advanced security function (/AS option))

Set recipients if you want an e-mail to be sent when a user lock out (user invalidation) occurs.

Mail Format

► For the mail format, see page 3-45 in section 3.2.5, "E-mail Format".

2.22.5 Setting the SNTP Client Function

Set the function used to query the time information server on the network for the time and synchronize the time.

Path

Web application: **Config. tab > Communication (Ethernet) settings > SNTP client settings**

Hardware configurator: **Communication (Ethernet) settings > SNTP client settings**

Description

SNTP client function

Setup Item	Selectable Range or Options	Default Value
On/Off	Off, On	Off

On/Off

Select **On** to use the SNTP client function.

SNTP server*

Setup Item	Selectable Range or Options	Default Value
SNTP server name	Character string (up to 64 characters, Aa#1)	—
Port number	Numeric value (1 to 65535)	123

* You can set this when the SNTP client function is set to **On**.

SNTP server name

Set the SNTP server name.

If the DNS is available, you can set the host name as a server name.

You can also set the IP address. In this case, the DNS is not required.

► For details on DNS, see page 2-154 in section 2.22.1, "Setting Basic Communication Conditions".

Port number

Set the port number of the SNTP server. Unless specified otherwise, you do not need to change this number.

Query action*

Setup Item	Selectable Range or Options	Default Value
Ref. time (Hour)	0 to 23	0
Ref. time (Minute)	0 to 59	0
Interval	6h, 12h, 24h	6h
Timeout	10s, 30s, 90s	30s
Time adjust on Start action	Off, On	Off

* You can set this when the SNTP client function is set to **On**.

Ref. time (Hour), Ref. time (Minute)

Set the reference time for making queries.

Interval

Set the time interval for synchronizing the time with the server.

Timeout

Set the time to wait for the response from the SNTP server when querying the time.

Time adjust on Start action

Set this to **On** to synchronize the time using SNTP when recording is started. When set to **ON**, the clock is adjusted when recording starts and when the GM recovers from power failures when recording is in progress.

2.22.6 Configuring the Modbus Client Function (/MC option)

Configuring Basic Settings

Path

Web application: **Config. tab > Communication (Ethernet) settings > Modbus client settings**

Hardware configurator: **Communication (Ethernet) settings > Modbus client settings**

Description

Modbus client function

Setup Item	Selectable Range or Options	Default Value
On/Off	Off, On	Off

On/Off

Select **On** to use the Modbus client function.

Communication¹

Setup Item	Selectable Range or Options	Default Value
Interval	100ms, 200ms, 500ms, 1s, 2s, 5s, 10s, 20s, 30s, 1min	1s

¹ You can set this when the Modbus client function is set to **On**.

Interval

Set the communication interval.

Recovery action^{*}

Setup Item	Selectable Range or Options	Default Value
Wait time	Off, 5s, 10s, 30s, 1min, 2min, 5min	2min

^{*} You can set this when the Modbus client function is set to **On**.

Wait time

Set the interval for retrying the connection when the connection is interrupted for some reason. Set this to **Off** to not retry connections. If communication fails, communication stops.

Connection¹

Setup Item	Selectable Range or Options	Default Value
Keep connection	Off, On	Off
Connection timeout ²	1 to 10 (s)	1

¹ You can set this when the Modbus client function is set to **On**.

² You can set this when Keep connection is set to **On**.

Keep connection

Set this to **On** to maintain the connection with the external device.

Connection timeout

If you set Keep connection to **On**, set the duration to maintain the TCP connection with the external Modbus device.

Explanation

Keep connection

Set whether to connect and disconnect TCP connections every time the GM accesses an external device.

If you set Keep connection to **On**, the TCP connection/disconnection procedure is skipped, thereby reducing the amount of communication traffic between the devices.

However, some devices do not support this feature. Use this feature after you check the specifications of the connected devices.

Even if Keep connection is set to **OFF**, if the communication interval is less than 1 s, communication is performed as if Keep connection set to **ON**.

Configuring the Destination Server

Path

Web application: **Config.** tab > **Communication (Ethernet) settings** > **Modbus server settings**

Hardware configurator: **Communication (Ethernet) settings** > **Modbus server settings**

Description

Modbus server settings

Setup Item	Selectable Range or Options	Default Value
Server number	GM10-1: 16 GM10-2: 32	—
Server name	Character string (up to 64 characters, A a 0-9)	—
Port number	Numeric value (1 to 65535)	502

Server number

Displays the registration number of the server to be configured.

Server name

Set the destination Modbus server name.

If the DNS is available, you can set the host name as a server name.

You can also set the IP address. In this case, the DNS is not required.

Port number

Set the port number of the selected server.

Unless specified otherwise, you do not need to change this number.

Setting Commands

Path

Web application: **Config. tab > Communication (Ethernet) settings > Modbus client command settings > Client command number** (display example: 1-20)
 Hardware configurator: **Communication (Ethernet) settings > Modbus client command settings > Client command number** (display example: 1-20)

Description

Client command number

Displays the transmission command number to be set.
 GM10-1: 100, GM10-2: 200

Command setting

Setup Item	Selectable Range or Options	Default Value
Type	Off/Read/Write	Off
Server*	GM10-1: 1 to 16 GM10-2: 1 to 32	1
Unit No.*	1 to 255	255
Data type*	INT16, UINT16, INT32_B, INT32_L, UINT32_B, UINT32_L, FLOAT_B, FLOAT_L, BIT	INT16
Register*	1 to 9999, 10001 to 19999, 30001 to 39999, 100001 to 165535 300001 to 365535, 40001 to 49999, 400001 to 465535	Read: 30001 Write: 40001
Channel type*	Read: Communication channel Write: IO channel, Math channel, Communication channel	Read: Communication channel Write: I/O channel
First-CH†	Same as the channel type	1
Last-CH†	Same as the channel type	1

* You can set this when the type not set to **Off**.

Type

Set the command type.

Server

Set the server number.

Unit No.

Set the fixed port number.

The unit number is used to specify a device connected through the Modbus gateway function.

To connect to the Modbus/TCP master of a UTAdvanced series, set the unit number to 1.

Data type

Set the data type. The data types that you can specify vary depending on the type of command.

▶ See page 4-10 in section 4.5, "Modbus Function and Register Assignments".

Register

Set the register number of the server.
 You can specify an input register in the range of 30001 to 39999 or 300001 to 365535. You can specify a hold register in the range of 40001 to 49999 or 400001 to 465535. You can specify a coil in the range of 1 to 9999 and input relay in the range of 100001 to 165535. The register numbers that you can specify vary depending on the type of command.

Channel type

When the type is set to **Read**, only communication channels are available.
 When the type is set to **Write**, set the channel type of the data to send.

First-CH, Last-CH

Set the first channel number and the last channel number in accordance with the channel type.

2.22.7 Configuring the Server Function

Path

Web application: **Config. tab > Communication (Ethernet) settings > Server function**
 Hardware configurator: **Communication (Ethernet) settings > Server function**

Description

Keep alive function

Setup Item	Selectable Range or Options	Default Value
On/Off	Off, On	On

On/Off

Set this to **On** to disconnect when there is no response to test packets that are periodically sent. Otherwise, set this to **Off**.

Timeout function

Setup Item	Selectable Range or Options	Default Value
On/Off	Off, On	Off
Timeout (minute)*	1 to 120	1

* You can set this when On/Off is set to **On**.

On/Off

Select **On** to use the communication timeout function.

Timeout (minute)

Set the timeout value.

Note

We recommend that you set either the Keep alive function or the Timeout function to **On**. If both the Keep alive function and the Timeout function are set to **Off**, you may not be able to connect to the server if the communication status is unstable or if the cable is disconnected and reconnected.

FTP server

Setup Item	Selectable Range or Options	Default Value
Output Directory Format	MS-DOS, UNIX	UNIX

Output Directory Format

Sets the directory output format.

Modbus server

Setup Item	Selectable Range or Options	Default Value
Modbus delay response	Off, 10ms, 20ms, 50ms	Off

Modbus delay response

To delay the responses to queries from the client, set the response delay value.

2.22.8 Limiting the Connection to the Modbus Server (GM)

Path

Web application: **Config. tab > Communication (Ethernet) settings > Allowed Modbus clients**

Hardware configurator: **Communication (Ethernet) settings > Allowed Modbus clients**

Description

Modbus client connect limits function

Setup Item	Selectable Range or Options	Default Value
On/Off	Off, On	Off

On/Off

Set this to **On** to limit the IP addresses that can connect to the GM Modbus server function. IP addresses other than those specified here will not be able to connect. To not limit connections, set this to **Off**.

1 to 10*

Setup Item	Selectable Range or Options	Default Value
On/Off	Off, On	Off
IP address	Numerical value (0.0.0.0 to 255.255.255.255)	0.0.0.0

* You can set this when the Modbus client connect limits function is set to **On**.

On/Off

Set this to **On** to set the IP addresses to allow connection. You can register up to 10 IP addresses.

IP Address

Set the IP addresses to allow connection (0.0.0.0 to 255.255.255.255). You cannot specify host names.

2.22.9 Setting the Server Functions to Use (FTP, HTTP, SNTP, MODBUS, GENE, DARWIN compatible communication)

- ▶ When using the OPC-UA server function (OPC-UA server (/E3 option)), see the OPC-UA Server (/E3) User's Manual (IM 04L51B-20EN).

Path

Web application: **Config.** tab > **Communication (Ethernet) settings > Server list**
 Hardware configurator: **Communication (Ethernet) settings > Server list**

Description

For each server service, there is a separate Update configuration button for applying the settings. Change the services one service at a time.

FTP

Setup Item	Selectable Range or Options	Default Value
On/Off	On/Off	On
Encryption*	On/Off	Off
Port number*	Numeric value (1 to 65535)	21

* You can set this when On/Off is set to **On**.

ON/Off

Select **On** to use the FTP server function.

Encryption

Set to **On** to encrypt using SSL the data exchanged via FTP.
 You need to create a key and a certificate.

- ▶ See page 2-214 in section 2.30, "Configuring Key Creation, Certificate Management, and Encryption/Certificate (SSL communication, PDF electronic signature)".

Port number

Set the port number of the FTP server. Unless specified otherwise, you do not need to change this number.

HTTP

Setup Item	Selectable Range or Options	Default Value
On/Off	On/Off	On
Encryption*	On/Off	Off
Port number*	Numeric value (1 to 65535)	80

* You can set this when On/Off is set to **On**.

ON/Off

Select **On** to use the Web server function.

Encryption

Set to **On** to encrypt using SSL the data exchanged via HTTP.
 You need to create a key and a certificate.

- ▶ See page 2-214 in section 2.30, "Configuring Key Creation, Certificate Management, and Encryption/Certificate (SSL communication, PDF electronic signature)".

Port number

Set the port number of the HTTP server. Unless specified otherwise, you do not need to change this number.

If encryption is set to On, the port number will be set to 443.

Note

- When you change the HTTP port to Off, you cannot later change it back to On. To change it back to On, use the SMARTDAC+ Hardware Configurator or a communication command (see the communication command manual).
- If the communication is disconnected due to a change in the HTTP port, do not close the browser, refresh the Web browser, or change the URL until the communication status icon turns off. Doing so may cause the closing of the browser or refreshing of the Web page to take a long time.

SNTP

Setup Item	Selectable Range or Options	Default Value
On/Off	On/Off	Off
Port number*	Numeric value (1 to 65535)	123

* You can set this when On/Off is set to **On**.

ON/Off

Select **On** to use the SNTP server function.

Port number

Set the SNTP port number. Unless specified otherwise, you do not need to change this number.

MODBUS

Setup Item	Selectable Range or Options	Default Value
On/Off	On/Off	Off
Port number*	Numeric value (1 to 65535)	502

* You can set this when On/Off is set to **On**.

ON/Off

Select **On** to use the Modbus server function.

Port number

Set the Modbus port number. Unless specified otherwise, you do not need to change this number.

GENE

Setup Item	Selectable Range or Options	Default Value
On/Off	On/Off	On
Port number*	Numeric value (1 to 65535)	34434

* You can set this when On/Off is set to **On**.

ON/Off

Select **On** to use the general purpose communication.

General purpose communication is a function for communicating with the GM using dedicated commands.

Port number

Set the port number to use for general purpose communication. Unless specified otherwise, you do not need to change this number.

DARWIN

Setup Item	Selectable Range or Options	Default Value
On/Off	On/Off	Off
Channel Conversion*	Stand-alone type, extended type	Stand-alone type

* You can set this when On/Off is set to **On**.

ON/Off

Select **On** to use DARWIN compatible communication.

Channel Conversion

Set the DARWIN model type.

The model type, channel number, and relay number are converted as follows.

Note

The channel conversion setting is shared with the channel conversion setting set with DARWIN in section, "2.23.1 Setting Basic Communication Conditions". Changing this setting will also change the channel conversion setting set with DARWIN in section, "2.23.1 Setting Basic Communication Conditions".

Stand-alone type

	DARWIN ↔ GM	Example
Channel number	0xx — 0?0 ↔ 0x0x — 0x?0	031 ↔ 0301, 040 ↔ 0310
Relay number	0xx — 0?0 ↔ 0x0x — 0x?0	031 ↔ 0301, 040 ↔ 0310

Extended type

	DARWIN ↔ GM	Example
Channel number	0xx — 5?0 ↔ 1x0x — 6x?0	031 ↔ 1301, 040 ↔ 1310
Relay number	1xx — 1?0 ↔ 0x0x — 0x?0	131 ↔ 0301, 140 ↔ 0310

- For details on the DARWIN compatible communication function, see page 2-220 in section 2.31, "Using the DARWIN Compatible Communication Function".

Note

The following numbers cannot be used for the port number of any of the server functions.
34437, 44818, 2222, 34150, 34151

2.22.10 Setting the Web Content Selection Tree

Path

Web application: **Config. tab > Communication (Ethernet) settings > Web content selection**

Hardware configurator: **Communication (Ethernet) settings > Web content selection**

Description

You can set whether to show or hide some of the contents shown on the Data tab of the Web application.

- When Communication of the security function is set to Login, only administrators can use this feature.
- When the Communication of the security function is set to Off, there are no restrictions on using this feature.

User level: User

Setup Item	Selectable Range or Options	Default Value
DO channel status/COMM status, etc.	On/Off	On
Log	On/Off	On
System information/Network information	On/Off	On
File	On/Off	On

DO Channel Status/COMM status, etc.

Set this to **Off** to hide the following contents on the Data tab.
DO channel, Internal switch, Modbus master, Modbus client, WT client

Log

Set this to **Off** to hide the log on the Data tab.

System information/Network information

Set this to **Off** to hide the system information and network information on the Data tab.

File

Set this to **Off** to hide Memory summary/Save, Report, Manual sample, Save/load on the Data tab.

User level: Monitor *

Setup Item	Selectable Range or Options	Default Value
DO channel status/COMM status, etc.	On/Off	On
Log	On/Off	On
System information/Network information	On/Off	On
File	On/Off	On

* You can set this when you are using the advanced security function (/AS option).

The settings are the same as those of the User user level except that Save/Load on the Data tab does not appear even if File is set to On.

2.23 Configuring the Serial Communication Function (/C3 option)

Set serial communication parameters.

2.23.1 Setting Basic Communication Conditions

Path

Web application: **Config.** tab > **Communication (Serial) settings** > **Serial basic settings**
 Hardware configurator: **Communication (Serial) settings** > **Serial basic settings**

Description

Receiver

Setup Item	Selectable Range or Options	Default Value
Function	Off, Normal, Modbus master (/MC option), Modbus slave, DARWIN	Normal
Address	When the function is Normal or DARWIN: 1 to 99 Other than Normal: 1 to 247	1

Function

Set the function to use. To use general purpose communication, select **Normal**.

Address

Set the GM address.

Function	Selectable Range or Options
Normal, DARWIN	1 to 99
Modbus master, Modbus slave	1 to 247

Data transfer*

Setup Item	Selectable Range or Options	Default Value
Baud rate	1200, 2400, 4800, 9600, 19200, 38400, 57600, 115200 (bps)	9600
Parity bit	None, Even, Odd	Even
Stop bit	1bit, 2bit	1bit
Data length	7bit, 8bit	8bit

You can set this when the receiver function is not set to **OFF**.

Baud rate

Set the baud rate.

Parity bit

Set the parity check method.

Stop bit

Set the stop bits.

Data length

Set the data length. To output the data in binary format, select **8bit**.

Logout*

Setup Item	Selectable Range or Options	Default Value
Auto logout	Off/1min/2min/5min/10min	Off

* You can set this when the receiver function is set to Normal, and in the security settings, communication is set to Login.

Auto Logout

Options	Description
Off	Stays logged in until the user logs out.
1 min to 10 min	When you log in through serial communication, you will be automatically logged out when there is no communication control for the specified duration.

DARWIN*

Setup Item	Selectable Range or Options	Default Value
Channel conversion	Stand-alone type, extended type	Stand-alone type

* You can set this when the receiver function is set to **DARWIN**.

Channel Conversion

Set the DARWIN model type.

The model type, channel number, and relay number are converted as follows.

Stand-alone type

	DARWIN ↔ GM	Example
Channel number	0xx — 0?0 ↔ 0x0x — 0x?0	031 ↔ 0301, 040 ↔ 0310
Relay number	0xx — 0?0 ↔ 0x0x — 0x?0	031 ↔ 0301, 040 ↔ 0310

Extended type

	DARWIN ↔ GM	Example
Channel number	0xx — 5?0 ↔ 1x0x — 6x?0	031 ↔ 1301, 040 ↔ 1310
Relay number	1xx — 1?0 ↔ 0x0x — 0x?0	131 ↔ 0301, 140 ↔ 0310

Note

The channel conversion setting is shared with the channel conversion setting set with DARWIN in section, "2.22.9 Setting the Server Functions to Use (FTP, HTTP, SNTP, MODBUS, GENE, DARWIN compatible communication)". Changing this setting will also change the channel conversion setting set with DARWIN in section, "2.22.9 Setting the Server Functions to Use (FTP, HTTP, SNTP, MODBUS, GENE, DARWIN compatible communication)".

- For details on the DARWIN compatible communication function, see page 2-220 in section 2.31, "Using the DARWIN Compatible Communication Function".

2.23.2 Enabling or Disabling the Modbus Master Function (/MC option) and Setting Communication Conditions

Path

Web application: **Config. tab > Communication (Serial) settings > Modbus master Basic settings**

Hardware configurator: **Communication (Serial) settings > Modbus master Basic settings**

Description

Master function

Setup Item	Selectable Range or Options	Default Value
On/Off	Off, On	Off

On/Off

Select **On** to use the Modbus master function.

Communication

Setup Item	Selectable Range or Options	Default Value
Interval	100ms, 200ms, 500ms, 1s, 2s, 5s, 10s, 20s, 30s, 1min	1s
Communication timeout	100ms, 200ms, 250ms, 500ms, 1s, 2s, 5s, 10s, 1min	1s
Gap between messages	Off, 5ms, 10ms, 20ms, 50ms, 100ms	Off

Interval

Set the data read cycle.

Communication timeout

Set the timeout value for the response from the specified slave when a command is sent from the GM.

Gap between messages

Set the amount of time to wait after receiving a response to a command to send the next command.

To connect a UTAdvanced series, set the gap between messages to 20 ms.

Recovery action

Setup Item	Selectable Range or Options	Default Value
Retransmission	Off, Once, Twice, 3 times, 4 times, 5 times, 10 times, 20 times	1
Wait time	Off, 5s, 10s, 30s, 1min, 2min, 5min	5s

Retransmission

Set the number of retransmissions when there is no response from the slave device.

Wait time

Set the auto recovery time from communication halt.

2.23.3 Setting Modbus Master Transmission Commands

Path

Web application: **Config. tab > Communication (Serial) settings > Modbus master Command settings > Master command number (display example: 1-20)**

Hardware configurator: **Communication (Serial) settings > Modbus master Command settings > Master command number (display example: 1-20)**

Description

Command settings

Setup Item	Selectable Range or Options	Default Value
Type	Off, Read, Write	Off
Slave*	1 to 247	1
Data type*	INT16, UINT16, INT32_B, INT32_L, UINT32_B, UINT32_L, FLOAT_B, FLOAT_L, BIT	INT16
Register*	1 to 9999, 10001 to 19999, 30001 to 39999, 100001 to 165535 300001 to 365535, 40001 to 49999, 400001 to 465535	Read: 30001 Write: 40001
Channel type*	Read: Communication channel Write: IO channel, Math channel, Communication channel	Communication channel
First-CH*	Channel of the channel type	—
Last-CH*	Channel of the channel type	—

* You can set this when the type not set to **Off**.

Type

Set the transmission command operation.

Slave

Set the address of the slave device.

Data type

Set the data type. The data types that you can specify vary depending on the type of command. ► See page 4-10 in section 4.5, "Modbus Function and Register Assignments".

Register

Set the register number of the slave. You can specify an input register in the range of 30001 to 39999 or 300001 to 365535. You can specify a hold register in the range of 40001 to 49999 or 400001 to 465535. You can specify a coil in the range of 1 to 9999 and input relay in the range of 100001 to 165535.

The register numbers that you can specify vary depending on the type of command. ► See page 4-10 in section 4.5, "Modbus Function and Register Assignments".

Channel type

When the type is set to **Read**, only communication channels are available.

When the type is set to **Write**, set the channel type of the data to send.

First-CH, Last-CH

Set the first channel number and the last channel number in accordance with the channel type.

2.24 Configuring the USB Communication Function

Turn the USB communication function on or off.

2.24.1 Turning the USB Communication Function On and Off

Path

Web application: **Config.** tab > **Communication (USB) settings**
 Hardware configurator: **Communication (USB) settings**

Description

USB communication

Setup Item	Selectable Range or Options	Default Value
On/Off	Off, On	On

On/Off

Select **On** to use the USB communication function.

Logout*

Setup Item	Selectable Range or Options	Default Value
Auto logout	Off/1min/2min/5min/10min	Off

* You can set this when in the security settings, communication is set to **Login**.

Auto logout

Options	Description
Off	Stays logged in until the user logs out.
1 min to 10 min	When you log in through USB communication, you will be automatically logged out when there is no communication control for the specified duration.

Explanation

USB Communication Function

Item	Specifications
Compliant standard	USB2.0
Interface	Connector: mini B type Number of ports: 1 Power supply: Self-powered
Communication conditions	Baud rate: 115200 bps Parity: None Data length: 8 bits Stop bits: 1 bit Handshake: Off

2.24.2 Connecting USB Communication

Connect a USB cable to the USB port.

A USB driver must be installed in the PC in advance.

If the PC is connected to Internet, a USB driver will be automatically downloaded and installed when the GM is connected to the PC.

For the USB driver download page, see the following Web site.

www.smartdacplus.com/software/en/

Note

If the driver fails to be downloaded properly, perform Update Driver Software from the Windows Device Manager.

2.25 Using the Bluetooth Communication Function (/C8 option)

Configure the settings for using the Bluetooth communication function.

2.25.1 Turning the Bluetooth Communication Function On and Off

Path

Web application: **Config.** tab > **Communication (Bluetooth) settings**
 Hardware configurator: **Communication (Bluetooth) settings**

Description

Bluetooth communication

Setup Item	Selectable Range or Options	Default Value
On/Off	Off, On	On

On/Off

Select **On** to use the Bluetooth communication function.

ID setting¹

Setup Item	Selectable Range or Options	Default Value
Local device name	Character string (up to 30 characters, Aa#1)	²

¹ You can set this when the Bluetooth communication function is set to **On**.

² Model-serial number (e.g., GM10-123456789)

Local device name

Assign a Bluetooth device name to the GM.

- The default name is "GM10-serial number." Change this if necessary.
- Note that loading a setting parameter file to another GM10 will cause the ID setting to also be loaded.

Bluetooth password*

Setup Item	Selectable Range or Options	Default Value
On/Off	Off, On	On
Password	Character string (up to 20 characters, Aa#1)	1234

* You can set this when the Bluetooth communication function is set to **On**. When Communication of the security function is set to **Login**, only administrators can use this feature.

On/Off

Set this to **On** to authenticate the password using the communication start command when establishing a connection.

Password

Set this when the password function is set to **On**.

Timeout function*

Setup Item	Selectable Range or Options	Default Value
Timeout	Off, 1min, 2min, 5min, 10min	Off

* You can set this when the Bluetooth communication function is set to **On**.

Timeout

Options	Description
Off	Disables the timeout function.
1 min to 10 min	After a connection is established, if no commands are received within the specified time, communication will be automatically disconnected.

Explanation

Bluetooth Communication Function

Item	Specifications
Compliant standard	Bluetooth Ver 2.1+EDR
Compatible profile	SPP (Serial Port Profile)
Carrier frequency band	2402 to 2480 MHz
Channel spacing	1 MHz
Number of channels	79
Communication distance	Approx. 10 m (depends on the operating environment) (Class 2)
Protocol	Dedicated protocol
Pairing	Maximum number of terminal device registrations: 8 (multi pairing) If the number of registrations exceeds 8, the registrations will be overwritten from the oldest ones.

2.25.2 Bluetooth Connection

Connection Procedure

To establish a Bluetooth connection, you need to set the Bluetooth function to **On** and switch to Enabled mode (see “Bluetooth Function Mode” on the next page).

The following procedure applies when you are connecting for the first time when the Bluetooth function is set to the default value.

Procedure

- 1 Check that the GM10 BT LED is not lit.
- 2 Hold down the GM10 **USER1** key for at least 3 seconds.
The BT LED (orange) will turn on, and the GM will enter the connection standby state.

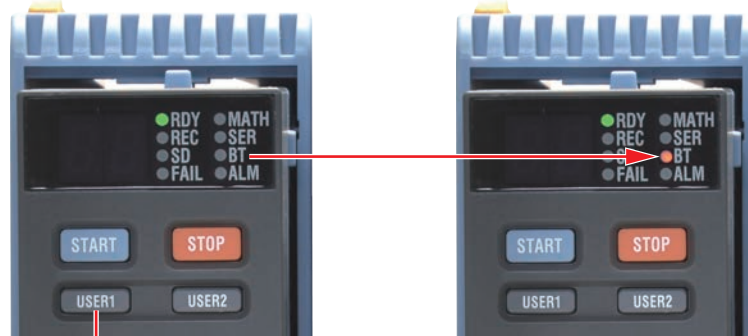

Hold down for at least 3 seconds.

BT LED lit: Enabled mode, connection standby state

BT LED blinking: Enabled mode, connected state

BT LED off: Disabled mode

- 3 Perform a pairing operation from the PC.
A 6-digit authentication code appears on the PC screen and GM10's 7 segment LED. Check that the authentication codes match, and pair the devices. When pairing is complete, a COM port will be assigned. You will need to configure the COM port when connecting. Check the COM port using Windows Device Manager.
- 4 Connect to the GM from the PC.
When connecting for the first time, you need to enter the password.
- 5 Enter 1234 (default value).
The BT LED will blink, and a connection will be established with the GM.

Explanation**Bluetooth Function Mode**

The Bluetooth communication function mode and state depending on the usage condition are shown below.

Item				Description
Function	Mode	State	BT LED	
On	Enabled mode	Connection standby	On	Bluetooth communication is disconnected. Bluetooth communication connection and pairing can be performed.
		Connected	Blinking	Bluetooth communication in progress. Using GM dedicated protocol communication commands, you can control and configure the GM and output data.
	Disabled mode	—	Off	Bluetooth communication is not usable (radio waves are not generated). To use Bluetooth communication, switch to Enabled mode.
Off	Disabled mode	—	Off	Bluetooth communication is not usable (radio waves are not generated). To use Bluetooth communication, switch to Enabled mode.

2.26 Configuring System Settings (Time zone, language, status relay, etc.)

Set the system environment such as the time zone and language.

2.26.1 Setting the Display Language, Temperature Unit, Decimal Point Type, and Date Format

Path

Web application: **Config**. tab > **System settings** > **Environment (Language) settings**
 Hardware configurator: **System settings** > **Environment (Language) settings**

Description

Environment (Language) settings

Setup Item	Selectable Range or Options	Default Value
Language	English, Japanese, German, French, Russian, Chinese, Korean, Italian	English
Decimal Point Type	Point, Comma	Point

Language

Set the language to use. The specified language is used in power-fail messages and other auto messages and the character strings in emails that are created.

Note

When you click Update configuration after changing the language, the message "Restart is required to reflect this changes. Continue?" may appear. Click OK, and the GM will automatically restart with the specified language.

Temperature unit

Set the temperature unit.

Decimal Point Type

Set the decimal point type.

Options	Display Example
Point	1234.56
Comma	1234,56

This is applied to the following files and displays. The decimal point of any file or setting not listed below (the setup screen for example) is displayed using a period.

Type	Item
File output	Manual sampled data file Report file Printer output Health monitor log data file
Screen	Trend display Digital display Bar graph display Overview display Historical trend Multi panel Report data display Health monitor log display
E-mail	The instantaneous value data in alarm e-mails and scheduled e-mails. The report data in report e-mails.

Date format

Setup Item	Selectable Range or Options	Default Value
Date format	Year Month Day, Month Day Year, Day Month Year	Year Month Day
Delimiter	Slash (/), Point (.), Hyphen (-)	Slash (/)
Month indicator	Characters, Numerical	Numerical

Date format

Set the date display format.

Options	Display example ¹
Year Month Day	2012/12/30
Month Day Year	12/30/2012
Day Month Year	30/12/2012

¹ In the display examples, the delimiter is a slash (/).

Scope

This is where the settings are retrieved from when **Sync with the hardware** in the Web Option settings* is executed. It does not change the date format on the date in the output data via communications, the date saved along with the data, and the date used in the data file names.

* For the web option settings, see page 3-41 in section 3.1.3, "Changing the Display Settings on the Browser".

Delimiter

Set the date delimiter.

Month indicator

Set whether to spell out months or use numbers on the screen.

2.26.2 Setting the Interval for Calculating the Rate-of-Change for Rate-of-Change Alarms

Path

Web application: **Config.** tab > **System settings** > **Alarm basic settings**
 Hardware configurator: **System settings** > **Alarm basic settings**

Description**Rate of change**

Setup Item	Selectable Range or Options	Default Value
Decrease	1 to 32	1
Increase	1 to 32	1

Decrease

Set the interval for the rate-of-change computation of the low limit on rate-of-change alarm in terms of the number of measured data values (1 to 32).* The actual interval is obtained by multiplying the value specified here by the scan interval.

* The number of measured data values is the number of samples.

Increase

Set the interval for the rate-of-change computation of the high limit on rate-of-change alarm in the same manner as the interval for the low limit on rate-of-change alarm.

2.26.3 Setting the Alarm Display Hold/Nonhold and Individual Alarm ACK Operation

Path

Web application: **Config.** tab > **System settings** > **Alarm basic settings**
 Hardware configurator: **System settings** > **Alarm basic settings**

Description

Indicator

Setup Item	Selectable Range or Options	Default Value
Hold/Nonhold	Hold, Nonhold	Nonhold

Hold/Nonhold

Set the alarm display behavior. This applies to both measurement alarms and control alarms.

Options	Description
Nonhold	Clears the alarm indication when the alarm condition is released (returns to normal condition).
Hold	Holds the alarm indication until an alarm acknowledge operation is performed.

The GM10 status display varies depending on the alarm display behavior settings.
 ► For details on the status display, see page 1-66 in section 1.7.2, “Status Display”.

Alarm ACK

Setup Item	Selectable Range or Options	Default Value
Individual alarm ACK	Off, On	Off

Individual alarm ACK

Set to On to perform individual alarm acknowledge.
 You can acknowledge alarms separately by channel and level.
 If set to On, Display settings are automatically set Hold.
 The Relay Action on ACK of all DO channels when an acknowledge is performed is Reset.
 Relay Action on ACK when the range type is set to Alarm in the DO settings of control settings is also set to Reset.

2.26.4 Setting the Time Zone, Gradual Time Adjustment, and Daylight Saving Time

Path

Web application: **Config.** tab > **System settings** > **Time basic settings**
 Hardware configurator: **System settings** > **Time basic settings**

Description

Time zone

Setup Item	Selectable Range or Options	Default Value
Hour	-13 to 13	9
Minute	0 to 59	0

Hour, Minute

Set the time zone of the region in which the GM will be used in terms of the time difference from GMT. A negative value indicates that the local time is behind the GMT.
 Example: The standard time in Japan is ahead of the GMT by 9 hours. In this case, set **Hour** to **9** and **Minute** to **0**.

Gradually adjusting the time

Setup Item	Selectable Range or Options	Default Value
Time deviation limit	Off, 5s, 10s, 15s	5s
Time adjustment beyond limit	Not Change the time, Change the time	Not Change the time

Time deviation limit

To gradually correct the time when the time is changed while recording is in progress, set the deviation limit for gradually correcting the time. Only when the time deviation between the GM's time and the specified time is within \pm (the value that you specify here) is the GM's time gradually corrected. Otherwise, the time is corrected according to **Time adjustment beyond limit**.

Options	Description
5 s to 15 s	The time deviation limit.
Off	Disables the function that gradually corrects the time.

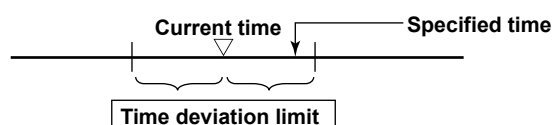

Time adjustment beyond limit

Set the behavior when a time that exceeds the time deviation limit is specified.

Options	Description
Not Change the time	Time is not corrected.
Change the time	Time is immediately corrected.

Daylight Saving Time

Setup Item	Selectable Range or Options	Default Value
Use/Not	Not, Use	Not

Use/Not

Set this to **On** to set Daylight Saving Time.

Daylight Saving Time Settings

Start time

Setup Item	Selectable Range or Options	Default Value
Month	January to December	March
Day order	1st, 2nd, 3rd, 4th, Last	2nd
Day of the week	Sunday to Saturday	Sunday
Hour	0 to 23	2

Month, Day order, Day of the week, Hour of the day

Set the date and time when daylight saving time starts.

Setup Item	Description
Month	Set the month.
Day order	Set the week in the month.
Day of the week	Set the day of the week.
Hour of the day	Set the hour. 0 to 23.

End time

Setup Item	Selectable Range or Options	Default Value
Month	January to December	November
Day order	1st, 2nd, 3rd, 4th, Last	1st
Day of the week	Sunday to Saturday	Sunday
Hour	0 to 23	2

Month, Day order, Day of the week, Hour of the day

Set the date and time when daylight saving time ends. The settings here are the same as those for Start time.

Explanation

Operation of Gradually Correcting the Internal Clock

If the time deviation between the time of the GM internal clock and the correct time (the specified time) is within a specified value, the GM clock is adjusted gradually at a rate of 1 ms per second. The maximum value of time deviation (t_m in the figure below) can be selected in the range of 5 s to 15 s.

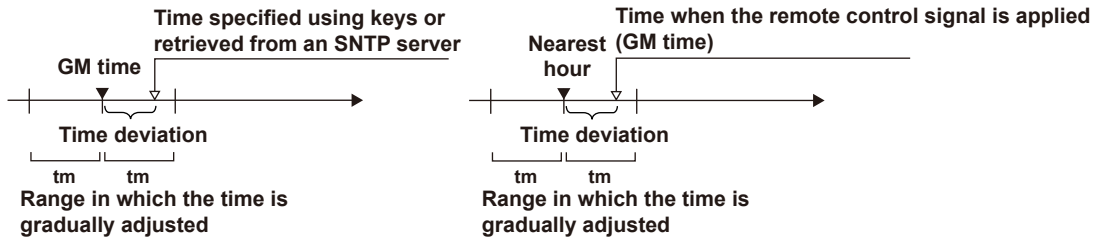

Example: When changing the time to 12 hours 55 minutes 35 seconds when the internal clock is 12 hours 55 minutes 32 seconds
 The time deviation of 3 seconds is adjusted 1 ms per second. The internal clock will be synchronized to the specified time 50 minutes later.

2.26.5 Setting Internal Switches

Path

Web application: **Config.** tab > **System settings** > **Internal switch settings**
 Hardware configurator: **System settings** > **Internal switch settings**

Description

Internal switch number

Displays the internal switch number (1 to 100) that you want to set.

Internal switch

Setup Item	Selectable Range or Options	Default Value
Type	Alarm, Manual	Alarm
And/Or	AND, OR	OR

Type

Set the item to assign to the internal switch.

Options	Description
Alarm	Assigns the internal switch as an alarm output destination.
Manual	Specify this to output using manual operation or event action.

And/Or

Set the internal switch operation conditions when multiple alarm outputs are assigned to the switch.

When the channel 1 alarm output and channel 2 alarm output are assigned, And and Or operations are as shown in the figure below.

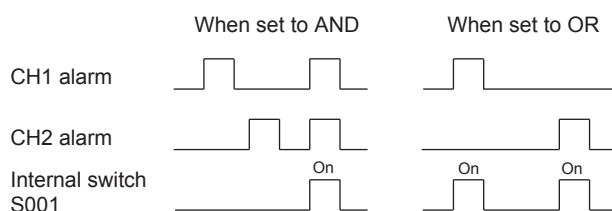

Preset action

Setup Item	Selectable Range or Options	Default value
At power-on	Last value, Off (0), On (1)	Off (0)

At power-on

Set the action at power-on.

Options	Description
Previous value	The internal switch state retains the previous value at power-on.
Off (0)	The internal switch state is set to Off (0) at power-on.
On (1)	The internal switch state is set to On (1) at power-on.

* The action at power-on can be set when the internal switch type is set to Manual.

2.26.6 Setting the Printer Output Conditions

Path

Web application: **Config. tab > System settings > Printer settings**
Hardware configurator: **System settings > Printer settings**

Setup Item	Selectable Range or Options	Default Value
IP address	0.0.0.0 to 255.255.255.255	0.0.0.0
Paper size	A4, A3, Letter	A4
Page orientation	Vertical, Horizontal	Vertical
Resolution (dpi)	300dpi, 600dpi	300dpi
Number of copies	1 to 10	1

IP address

Set the IP address of the printer.

Paper size

Set the size of the paper to print.

Page orientation

Set the print orientation.

Resolution (dpi)

Set the print resolution.

Number of copies

Set the number of copies to print.

Note

If an SD memory card is not inserted, report printing using report templates is not possible.

Compatible printers

Printers supporting the HP PCL5c language and can print through port 9100 on a LAN connection

2.26.7 Setting Instrument Tags

Path

Web application: **Config. tab > System settings > Instruments tag**
 Hardware configurator: **System settings > Instruments tag**

Description

Setup Item	Selectable Range or Options	Default Value
Instruments Tag	Character string (up to 32 characters, Aa#1)	—
Instruments tag No.	Character string (up to 16 characters, Aa#1)	00

Instruments Tag

Set the GM instrument tag.

Instrument tag No.

Set the GM instrument tag number.

The first two characters of the instrument tag number are displayed as a system number on the 7 segment LED. If the first two characters of the instrument tag number setting are not between 0 and 9 or space, the system number is displayed as 0.

► For details on the 7 segment LED, see page 1-65 in section 1.7.1, “7 segment LED”.

Note

Note that loading a setting parameter file to another GM10 will cause the tag settings to also be loaded.

2.26.8 Setting Comments to Setting Parameter Files

Path

Web application: **Config. tab > System settings > Setting file**
 Hardware configurator: **System settings > Setting file**

Description

Setup Item	Selectable Range or Options	Default Value
Setting file comment	Character string (up to 50 characters, Aa#1)	—

Setting file comment

Set the comment to attach to the setting parameter file.

Configuration changes comment (for the advanced security function (/AS option))

Setup Item	Selectable Range or Options	Default Value
Input comment	Off, On	Off

Input Comment

Set this to On to enter comments in setting files when settings are changed.

Configuration change comments are also recorded to the event log (spaces cannot be used to enter comments). You can enter configuration change comments when recording is in progress.*

The Update configuration dialog box appears when you change the settings. The comment text box displays the content set in Setting file comment. If you change the text, the content set in Setting file comment will be updated.

* release number 4 (version 4.07) and later

2.27 Configuring the Security Functions

Set the security function. The login function allows only registered users to use the GM. Access from communication functions can also be limited to users registered here. Authority of user can be configured to restrict the items that each user is allowed to use. (Up to 10 conditions can be set.)

The key lock function prohibits the use of the GM10's START, STOP, and USER1/USER2 keys (with the exception of clearing errors with the STOP key).

If you are using the advanced security function (/AS option), see the Advanced Security Function User's Manual (IM 04L55B01-05EN).

Security features

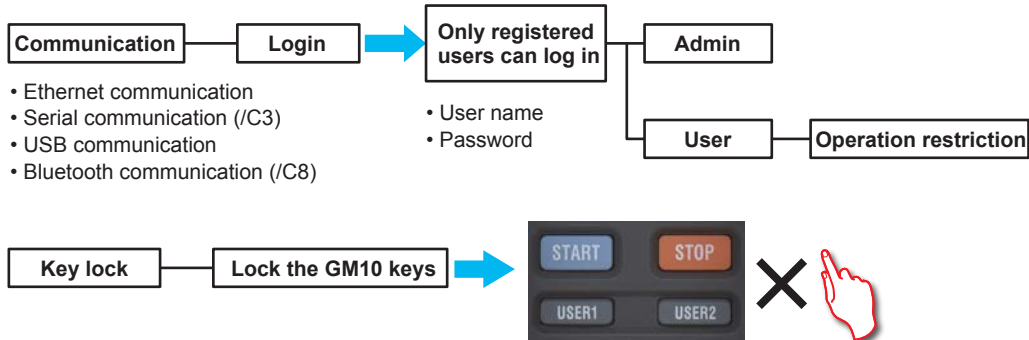

2.27.1 Configuring the Security Functions

Path

Web application: **Config. tab > Security settings > Security basic settings**
 Hardware configurator: **Security settings > Security basic settings**

Description

Security function

Communication

To apply communication access security, set this to **Login**.

Options	Description
Off	Disables the security function
Login	Allows only registered users to access the GM via communication

Explanation

Login

Log in by entering the user name and password in the following situations.

GM Access	Login Necessary
Communication	When accessing general purpose communication, FTP server, or Web server

Note

- If the communication login is changed from **Off** to **Login**, the GM login function will be enabled immediately, and authentication will be required. We recommend that you check or register users in User settings beforehand.
 - ▶ See page 2-189 in section 2.27.2, "Setting Registered User Conditions (When touch operation or communication is set to login)"
- In Chrome, turn on "Allow Chrome sign-in," and then clear the cache. If you do not clear the cache, the browser will clear the user name and password you are trying to enter in the user authentication dialog box before you can finish typing.

2.27.2 Setting Registered User Conditions (When touch operation or communication is set to login)

Path

Web application: **Config.** tab > **Security settings** > **User settings**
 Hardware configurator: **Security settings** > **User settings**

Description

User number

Displays the user registration number (1 to 50).

User settings

Setup Item	Selectable Range or Options	Default Value
User level	Off, Admin, User	—
Mode	Communication	Communication
User name	Character string (up to 20 characters, Aa#1)	—
Initialize password	Initialize	—
Authority of user ¹	Off, On	Off
Authority number ²	Authority number 1 to 10	1

- 1 You can set this when the user level is set to **User**.
- 2 You can set this when Authority of user is set to **On**.

User Level

Set the user level. System administrators (Admin) are users that can perform all operations on the GM. When using the login function, at least one user must be registered as a system administrator. The user level of User number 1 is fixed to **Admin**.

User-level users cannot configure security settings, perform A/D calibration, configure the encryption function or create keys for encryption/certificate, or update the firmware.

Mode

Options	Description
Communication	You can log in to the GM via communication.

User name

Set the user name. Duplicate user names are not allowed.
 User names cannot contain spaces.

Initialize password

Web application: Select the Initialize password check box, and click **Update** configuration.
 To cancel initialization, click **Cancel**.

Hardware configurator: Click **Change** next to the password, and enter the password in the New Password and New Password Again boxes.

Authority of user

When the user level is **User**, set this to **On** to apply user restrictions.

Authority number

When Authority of user is set to **On**, set the authority number.
 For details on setting user restrictions, see the next section.

Note

Default user names are "User01" to "User50" for user number 1 to user number 50, respectively.
 The default password is "default."
 To change a password, log in and perform **Password change**.

2.27.3 Setting User Restrictions (when communication is set to login)

Path

Web application: **Config. tab > Security settings > Authority of user**
 Hardware configurator: **Security settings > User property***
 * Appears when **Communication** of the security function is set to **Login**

Description

Authority number

Select the user number (1 to 10) to apply user restrictions.

Authority of user

For details on controls, see the *Loop Control Function, Program Control Function (/PG Option) User's Manual* (IM 04L51B01-31EN).

Setup Item	Selectable Range or Options	Default Value
Record	Free, Lock	Free
Math	Free, Lock	Free
Data save	Free, Lock	Free
Message	Free, Lock	Free
Batch	Free, Lock	Free
Alarm ACK	Free, Lock	Free
Communication	Free, Lock	Free
Time set	Free, Lock	Free
Setting operation	Free, Lock	Free
External media	Free, Lock	Free
System operation	Free, Lock	Free
Output operation	Free, Lock	Free

Record

Set this to **Lock** to restrict record start/stop operation.

Math

Set this to **Lock** to restrict the math operations below.

Operation
Start computation
Stop computation
Reset computation

Data save

Set this to **Lock** to restrict the data save operations below.

Operation
Save display data
Save event data
Event trigger
Manual sample
Reset timer
Reset match time timer

Message

Set this to **Lock** to restrict message writing operation.

Batch

Set this to **Lock** to restrict the batch operations below.

Operation
Write batch numbers
Write lot numbers
Write comments
Write in text fields
Predictive detection section start, stop, hold

2.28 Saving and Loading Settings

This section explains how to save, load, and delete setting parameters, report templates, profile trend (/MC option)(Release number 5 and later), predictive detection model (Release number 5 and later), trusted certificates, and program patterns (/PG option) (Release number 4 and later).

2.28.1 Saving, Loading, and Deleting GM Setting Parameters

Path

Web application: **Data** tab > **Save/Load** > **Setting parameters**

Saving Setting Parameters

You can save GM setting parameters to an SD card.

Description

Setup Item	Selectable Range or Options	Default Value
File name	Character string (up to 32 characters, Aa#1)	—
Comment	Character string (up to 50 characters, Aa#1)	—

File name

Set the file name.

Comment

Set this to attach a comment to the file that you are saving.

Procedure

- 1** Select the save destination folder.
- 2** Double-click a folder to show the folders and files in that folder.
Click the  **move to the higher level folder** button to move to the higher level folder.
- 3** Enter the file name in the **File Name** text box.
You do not have to enter the extension. You can also click a file in the list to display the file name in the **File Name** text box.
- 4** Click **Save**.
The **Save as configuration file** dialog box appears.
- 5** Enter a command, and click **Save**.
To not save, click **Cancel**.
The setting parameters are saved, and the **Save as configuration file** dialog box closes.



Note

- Folders and files are not displayed if their names contain single quotation marks or semicolons.
- If a file with the same name exists, overwriting is indicated.

Loading Setting Parameters

You can load GM setting parameters from an SD card into the GM.

Description

Setup Item	Selectable Range or Options	Default Value
Security	Off, On	Off
Control settings ²	Off, On	On
IP address	Off, On	Off
Other	Off, On	On
Communication(Server settings) ¹	Off, On	On
Calibration correction settings ¹	Off, On	On
Instruments tags, etc. ¹	Off, On	On

1 You can set this when Other is set to On.

2 This is displayed when a PID control module is detected. Release number 4 and later.

Security

Set this to **On** to load only the security settings.

Note

If the advanced security function (/AS option) is in use, passwords are not loaded except for monitor users. All administrator, second administrator and user passwords are set to their defaults. See "Reusing Setting Parameters" section 1.3.4, "User Levels," in the Advanced Security Function (/AS) User's Manual (IM 04L55B01-05EN).

Control settings

Set this to **On** to load control settings.

Setup items that are loaded

- Control settings
- Program pattern settings
- Control event action

IP address

Set this to **On** to load the IP address, DHCP, and DNS settings.

Other

Set this to **On** to load settings other than security, IP address, or control settings.

Communication (Server settings)

Set this to **On** when you want to load the server list settings, server encryption settings, and channel conversion setting of DARWIN compatible communication.

Calibration correction settings

Set this to **On** to load calibration correction settings and calibration reminder settings (/AH option).

Instruments tags, etc.

Set this to **On** to load tag settings and the ID setting of Bluetooth communication.

Procedure

1

Select the file you want to load.

The selected file name appears in the **File Name** text box.

If you double-click the file name, the Load from configuration file dialog box appears. In this case, proceed to step 3.

2

Click **Load**.

The **Load from configuration file** dialog box appears.

3

Specify what types of settings to load into the GM using **On** and **Off**. Settings that are set to **On** will be loaded.

- 4** Click **Load**.
To not load, click **Cancel**.

The setting parameters are applied to the GM, and the Load as configuration file dialog box closes.

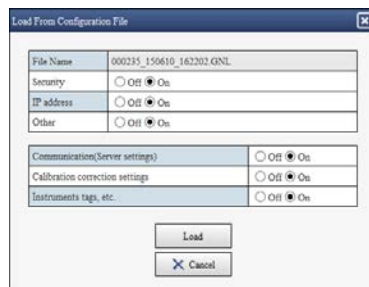

Note

- When the language setting is changed, the GM may restart.
- Folders and files are not displayed if their names contain single quotation marks or semicolons.
- It is possible that as a result of loading setting parameters, the Web application no longer runs properly or the GM restarts automatically.
- When loading security settings
Changes to the security settings may require a login. Check the security settings in the setting parameter file before loading. You can use the SMARTDAC+ Hardware Configurator for this purpose.
- When loading IP address settings
Changes to the IP address may cause the connection to be disconnected. If this occurs, you can use the SMARTDAC+ Hardware Configurator to check the IP address.

Explanation

Setting Parameter Files

- The extension is .GNL.
When the advanced security function (/AS option) is in use, the extension is .GSL.

Deleting a Setting Parameter File

You can delete GM setting parameters from an SD card.

Procedure

- 1** Select the file you want to delete.
The selected file name appears in the **File Name** text box.
- 2** Click **Delete**.
The File dialog box appears.
The message "Delete the file?" appears.
- 3** Click **OK**.
The file is deleted.
To not delete, click **Cancel**.

2.28.2 Downloading Files

You can download files in the SD card to your PC.

Procedure

- 1** Under Save/Load on the Data tab, show the screen containing the file you want to download.
- 2** Select the file you want to download.
The selected file name appears in the **File Name** text box.
- 3** Click **Download**.
Follow the instructions in the dialog box that appears.

2.28.3 Saving and Loading Report Templates (/MT option)

- For the procedure, see page 2-192 in section 2.28.1, “Saving, Loading, and Deleting GM Setting Parameters”.

Path

Web application: **Data** tab > **Save/Load** > **Report template**

Saving a Report Template

Description

Setup Item	Selectable Range or Options	Default Value
File type	Excel file, PDF/Printer file	Excel file
File name	Character string (up to 32 characters, Aa#1)	—

File type

Set the type of file to save.

File name

Set the file name.

Setup Item	Selectable Range or Options	Default Value
Report kind	Hourly, Daily, Weekly, Monthly, Hourly + Daily, Daily + Weekly, Daily + Monthly, Batch, Daily custom	Hourly
Data	—	—

Report kind

Set the kind of report template.

Data

Displays the presence or absence of the specified file.

Loading a Report Template

Description

Setup Item	Selectable Range or Options	Default Value
File type	Excel file, PDF/Printer file	Excel file
Select file	—	—

File type

Set the file type.

Select file

Set the file to load.

Setup Item	Selectable Range or Options	Default Value
Report kind	Hourly, Daily, Weekly, Monthly, Hourly + Daily, Daily + Weekly, Daily + Monthly, Batch, Daily custom	Hourly
Data	—	—

Report kind

Set the kind of report template.

Data

Displays the presence or absence of the specified file.

2.28.4 Saving and Loading Setting Parameters, Report Templates, Trusted Certificates, Program Patterns (/PG option) (Release number 4 and later), Profile Trend (/MC option)(Release number 5 and later), Predictive Detection Model (Release number 5 and later)

Path

Web application: **Data** tab > **Save/Load** > File list(Save all/Load all)

Description

Select folder

Set the folder.

File Structure When Saving All Settings and Loading All Settings

When you save all settings, the following folders and files are saved in the specified folder.

File structure when saving all settings	Description
Config.GNL ¹	Setting parameter file
Report YY.ZZ ^{2, 3, 4}	Report template file (Excel format)
Report YY.TPL ^{2, 3}	Report template file (PDF format)
Client (folder) ⁵	Trusted certificate folder
YYMMDD_HHMMSS_FileName.CER ⁶	Trusted certificate
Server (folder) ⁷	Server certificate folder
commu_server_cert.CER	Server certificate (communication)
N_commu_chained_cert.CER ⁸	Intermediate certificate (communication)
pdf_server_cert.CER	Server certificate (PDF)
N_pdf_chained_cert.CER ⁸	Intermediate certificate (PDF)
ProgramPattern (folder)	Pattern file folder
ProgPatGG.GPT ⁹	Pattern file
Profile (folder)	Profile trend folder
Profile.GPF	Profile trend file
Model (folder)	Predictive detection model folder
****.GDG (**** is the file name when loading.)	Predictive detection model file

1 If the advanced security function is enabled (On), the extension is .GSL.

2 An extension appropriate for each report type is entered in "YY."

YY	Report type	YY	Report type	YY	Report type
H	Hourly	M	Monthly	DM	Monthly + daily
D	Daily	HD	Hourly + Daily	BT	Batch
W	Weekly	DW	Daily + weekly	CT	Custom

3 If a report template file is not loaded, it is not saved.

4 The Excel file format (.xlsx or .xlsm) is entered in "ZZ."

5 If a trusted certificate is not loaded, it is not saved.

6 The date and time are entered in "YYMMDD_HHMMSS."

7 If a server certificate or intermediate certificate is not installed, it is not saved.

8 A serial number assigned when the intermediate certificate was installed is entered in "N." All the installed intermediate certificates are saved.

9 Pattern number (01 to 99) appears in "GG".

When you load all settings, files are loaded according to the file structure for when saving all settings.

To use files that are created by saving all settings, you can simply specify the folder.

To use files other than those created by saving all settings, note the following.

- Use the following file structure. Files that do not comply with the structure or those that do not use the following names will not be loaded when you load all settings.
- Server certificates are not installed when you load all settings.

File structure when loading all settings	Description
Config.GNL	Use the file name shown on the left. If the advanced security function is enabled (On), set the extension to .GSL.
Report_YY.ZZ	Use the file name shown on the left. For “YY” and “ZZ,” see the file structure for when saving all settings.
Report_YY.TPL	Use the file name shown on the left. For “YY,” see the file structure for when saving all settings.
Client (folder)	If the folder name is not “Client,” the trusted certificates inside the folder will not be loaded.
YYMMDD_HHMMSS.FileName.CER	The file will be loaded as long as the extension is .cer.
ProgramPattern (folder)	If the folder name is not “ProgramPattern,” the pattern files in the folder will not be loaded.
ProgPatGG.GPT	Use the file name shown on the left. For “GG,” see the file structure for when saving all settings.
Profile (folder)	If the folder name is not “Profile,” the profile trend files in the folder will not be loaded.
Profile.GPF	Use the file name shown on the left.
Model (folder)	If the folder name is not “Model,” the predictive detection model files in the folder will not be loaded.
FileName.GDG	The file will be loaded as long as the extension is .gdg.

Load all settings

- 1 Move to the folder containing the setting parameter files you want to load.
- 2 Click **Load all settings**.
- 3 Click **OK**.
All the files are loaded.

Operation complete

Note

The conditions for loading files depend on the contents of the setting parameters, report templates, and trusted certificates. Check the contents before loading them.

Save all settings

- 1 Move to the save destination folder.
- 2 Click **All settings save**.
- 3 Enter the folder name in the **Folder Name** text box.
- 4 Click **OK**.
All the files are saved.
Setting parameters, report templates, and trusted certificates are saved.

Operation complete

2.28.5 Saving, Loading, and Deleting Trusted Certificates

To use this function, you must set **Calib** tab > **Encryption/Certificate** > **Encryption function** to **On**.

- ▶ For instruction on how to use the Open folder, reload, Download, and Delete buttons, see page 2-192 in section 2.28.1, “Saving, Loading, and Deleting GM Setting Parameters”.

Path

Web application: **Data** tab > **Save/Load** > **Trusted Certificate**

Viewing a Certificate

Click **View certificate**. A Trusted Certificate dialog box opens, and the currently loaded trusted certificates appear. Select a file in the dialog box to view the certificate information (see Certificate information for details).

Saving Trusted Certificates

Description

Click **Save** to save test certificates. Here, you cannot specify the file names. A number indicating the time when the files are saved are appended to the file names and saved.

Example: If two loaded certificate files, 001_abcd.cer and 002_efgh.cer, are saved at 2014/12/30 15:23:38, they are saved with the file names “141230_152338_001_abcd.cer” and “141230_152338_002_efgh.cer.”

Loading Trusted Certificates

Description

Select the name of the certificate file you want to load from the external medium, and click **Load**. A Load Trusted Certificate dialog box appears, and the following certification information is displayed. Check the information and click **Load** to load the certificate.

Certificate Information

Setup Item	Selectable Range or Options	Default Value
File name	—	—
Issuer	—	—
Subject	—	—
Valid not before	—	—
Validity not after	—	—
Front half of hash value (SHA1)	—	—
Latter half of hash value (SHA1)	—	—

Issuer, Subject, Valid not before, Validity not after, Front half of hash value (SHA1), Latter half of hash value (SHA1)

The items in the file to be loaded are displayed.

- For details, see page 2-214 in section 2.30, “Configuring Key Creation, Certificate Management, and Encryption/Certificate (SSL communication, PDF electronic signature)”.

Deleting a Trusted Certificate

Description

Select file

Click **View certificate**. A Trusted Certificate dialog box opens. In the dialog box, select the file you want to delete, and check the following certificate information. Click **Delete displayed certificate** to delete the certificate.

Certificate Information

Setup Item	Selectable Range or Options	Default Value
Issuer	—	—
Subject	—	—
Valid not before	—	—
Validity not after	—	—
Front half of hash value (SHA1)	—	—
Latter half of hash value (SHA1)	—	—

Issuer, Subject, Valid not before, Validity not after, Front half of hash value (SHA1), Latter half of hash value (SHA1)

The items in the certificate to be deleted are displayed.

- For details, see page 2-214 in section 2.30, “Configuring Key Creation, Certificate Management, and Encryption/Certificate (SSL communication, PDF electronic signature)”.

2.28.6 Saving, Loading, and Deleting Program Patterns (/PG option) (Release number 4 and later)

Each program pattern is saved to a separate file.

Saving a Specified Pattern

Path

Web application: **Data** tab > **Save/Load** > **Program pattern**

Description

Setup Item	Selectable Range or Options	Default value
Pattern number	1 to 99	1
Pattern name	—	—
File name	Character string (up to 32 characters, Aa#1)	—

Pattern number

Set the pattern number to be loaded. If there is not a loaded pattern, “No pattern” is displayed.

Pattern name

The name of the pattern is displayed.

File name

The name of the file to be saved is displayed.

Procedure

- 1** Enter the file name in the **File Name** text box.
You do not have to enter the extension. You can also click a file in the list to display the file name in the **File Name** text box.
- 2** Click **Save specified program pattern**.
A **Save specified program pattern** dialog box appears.
- 3** Select the pattern number you want to save from the pattern number list.
- 4** Select the pattern number you want to load from the pattern number list.
- 5** Click **Save** (or **Overwrite** to overwrite).
To not save, click **Cancel**.
The specified pattern is save to an external storage medium.

[Operation complete](#)

Saving All Patterns

Path

Web application: **Data** tab > **Save/Load** > **Program pattern**

Procedure

- 1** Click **Save all program patterns**.
A **Save all program patterns** dialog box appears.
- 2** Enter the folder name in the folder name text box.
- 3** Click **Save**.
To not save, click **Cancel**.

[Operation complete](#)

Loading a Specified Pattern

Path

Web application: **Data** tab > **Save/Load** > **Program pattern**

Description

Setup Item	Selectable Range or Options	Default value
File name	—	
Pattern number	1 to 99	1
Pattern name	—	—
File	—	

File name

The file name is displayed.

Pattern number

Set the pattern number to be loaded.

Pattern name

The name of the pattern is displayed.

File

The presence or absence of pattern files is displayed.

Procedure

- 1** Select the program pattern file you want to load.
The selected file name appears in the **File Name** text box.
- 2** Click **Load specified program pattern**.
A **Load specified program pattern** dialog box appears.
- 3** Select the pattern number you want to load from the pattern number list.
- 4** Click **Load**.
To not load, click **Cancel**.
The specified pattern is applied to the GM, and the Load specified program pattern dialog box closes.

Loading All Patterns

Path

Web application: **Data** tab > **Save/Load** > **Program pattern**

Procedure

- 1** Move to the folder containing the setting parameter files you want to load.
- 2** Select **Load all program patterns**.
To not load, click **Cancel**.
A **Load all program patterns** dialog box appears.
- 3** Click **Load**.
All patterns are loaded.

[Operation complete](#)

Deleting a Specified Pattern

Path

Web application: **Data** tab > **Save/Load** > **Program pattern**

Description

Setup Item	Selectable Range or Options	Default value
Pattern number	1 to 99	1
Pattern name	—	—

Pattern number

Set the number of the pattern to delete.

Pattern name

The name of the pattern is displayed.

Procedure

- 1** Click **Delete specified program pattern**.
- 2** Select the number of the pattern to delete.
- 3** Click **Delete**.
The specified pattern is deleted.

[Operation complete](#)

Deleting All Patterns

Path

Web application: **Data** tab > **Save/Load** > **Program pattern**

Description

Setup Item	Selectable Range or Options	Default value
Delete all program patterns	—	—

Delete all program patterns

Displays the presence or absence of patterns.

Procedure

- 1** Click **Delete all program patterns**.
- 2** Click **Delete**.
All patterns are deleted.

[Operation complete](#)

2.28.7 Saving and loading profile trends (Release number 5 and later)

- ▶ For instruction on how to use the Open folder, reload, Download, and Delete buttons, see page 2-192 in section 2.28.1, “Saving, Loading, and Deleting GM Setting Parameters”.

Saves the profile trend

Path

Web application: **Data** tab > **Save/Load** > **Profile trend**

Description

Setup Item	Selectable Range or Options	Default value
File name	Character string (up to 32 characters, Aa#1)	—

File name

Sets the file name.

Procedure

- 1 Enter the file name in the **File Name** text box.
You do not have to enter the extension. You can also click a file in the list to display the file name in the **File Name** text box.
- 2 Click **Save**.
A dialog box appears.
- 3 Click **Save** (or **Overwrite** to overwrite).
To not save, click **Cancel**.
The data is saved to an external storage medium.

Operation complete

Loads the profile trend

Note

If the profile waveform is loaded during the early warning detection interval, the profile waveform reading and the determination of the profile alarm are stopped.

Path

Web application: **Data** tab > **Save/Load** > **Profile trend**

Description

Setup Item	Selectable Range or Options	Default value
File name	—	—

File name

Displays the file name.

File information

Setup Item	Selectable Range or Options	Default value
Channel	—	—

Channel

You can select the file and click **File Information** to display the target channel in the file.

Procedure

- 1** Select the file you want to load.
The selected file name appears in the **File Name** text box.
- 2** Click **Load**.
A dialog box appears.
- 3** Click **Load** (or **Overwrite** to overwrite).
The selected file is loaded.

[Operation complete](#)

2.28.8 Saving and loading early warning detection models (Release number 5 and later)

► For instruction on how to use the Open folder, reload, Download, and Delete buttons, see page 2-192 in section 2.28.1, “Saving, Loading, and Deleting GM Setting Parameters”.

Saves the predictive detection model

Path

Web application: **Data** tab > **Save/Load** > **Predictive detection model**

Description

Setup Item	Selectable Range or Options	Default value
File name	Character string (up to 32 characters, Aa#1)	—

File name

Sets the file name.

Procedure

- 1** Enter the file name in the **File Name** text box.
You do not have to enter the extension. You can also click a file in the list to display the file name in the **File Name** text box.
- 2** Click **Save**.
A dialog box appears.
- 3** Click **Save** (or **Overwrite** to overwrite).
To not save, click **Cancel**.
The data is saved to an external storage medium.

[Operation complete](#)

Loads the predictive detection model

Path

Web application: **Data** tab > **Save/Load** > **Profile trend**

Description

Setup Item	Selectable Range or Options	Default value
File name	—	—

File name

Displays the file name.

File information

Setup Item	Selectable Range or Options	Default value
Channel	—	—

Channel

You can select the file and click **File Information** to display the target channel in the file.

Procedure

- 1** Select the file you want to load.
The selected file name appears in the **File Name** text box.
- 2** Click **Load**.
A dialog box appears.
- 3** Click **Load** (or **Overwrite** to overwrite).
The selected file is loaded.

[Operation complete](#)

2.28.9 Saving All the Data* in the Internal Memory

You can save all the data in the internal memory to an SD card memory.

* Display and event data, manual sample data, and report data

- 1** On the Data tab, click Save/Load and then File list (Save all/Load all).
A File list screen appears.
- 2** Click All save.
An All save dialog box appears.
- 3** Click **Save to SD card**.
The data is saved.

[Operation complete](#)

Data Save Destination

The GM will create a new directory to store the data in each time you save data.

Directory name: Specified string_YYMMDD_HHMMSS (the values of YY to SS are the date and time of operation)

Example: DATA0_141205_184500

You can set the “specified string” by clicking Data save settings on the Setting tab.

After saving is complete, click Reload to display the save destination directory.

2.29 Initializing and Calibrating the System (Initialization, reconfiguration), Setting the Measurement Mode

Initialize the settings or the internal memory, and reconfigure the GM.

- ▶ For details on A/D calibration, see page 5-5 in section 5.1.3, “Performing A/D Calibration and Adjusting the Input Accuracy of an AI Module”.
- ▶ For details on the advanced security settings (when the advanced security function (/AS option) is in use), see section 2.5, “Disabling the Advanced Security Function,” in the Advanced Security Function (/AS) User’s Manual (IM 04L55B01-05EN).
- ▶ For details on encryption and certificates, see page 2-214 in section 2.30, “Configuring Key Creation, Certificate Management, and Encryption/Certificate (SSL communication, PDF electronic signature)”.
- ▶ For details on updating the firmware (Web application, I/O module, and expansion module), see page 5-17 in section 5.1.8, “Updating the Firmware”.
- ▶ For the multi-batch settings (multi batch function (/BT option)), see the Multi-batch Function (/BT) User’s Manual (IM 04L51B01-03EN).

2.29.1 Initializing the Settings and the Internal Memory

Path

Web application: **Option** tab > **Initialize** > **Settings/Internal data**

Description

Setup Item	Selectable Range or Options	Default Value
Initialize	Initialize all, Initialize all except communication settings, Separate	Separate

Initialize all

Set this to **On** to initialize all settings and return the GM to its factory default condition. However, the A/D calibration password is not initialized.

Initialize all except communication settings

Set this to **On** to initialize all settings except Communication(IP address) and Communication(Server settings).

However, the A/D calibration password is not initialized.

Separate

Set each setting to **On** when you want to initialize the following settings. However, the A/D calibration password is not initialized.

Security settings, Communication(IP address), Communication(Server settings), Calibration correction settings, Instruments tags, etc., Internal data

Config.

Setup Item	Selectable Range or Options	Default Value
Security settings ^{1,4}	Off, On	Off
Control settings ⁶	Off, On	Off
Other ^{2,4}	Off, On	Off
Communication(IP address) ^{3,5}	Off, On	Off
Communication(Sever settings) ^{3,5}	Off, On	Off
Calibration correction settings ^{3,4}	Off, On	Off
Instruments tags, etc. ^{3,4}	Off, On	Off

- 1 When Communication of the security function is set to Login, only administrators can use this feature.
- 2 You can set this when Initialize is set to Separate.
- 3 You can set this when Other than Security settings set to On.
- 4 This is fixed to On when Initialize is set to Initialize all or Initialize all except communication settings.
- 5 This is fixed to On when Initialize is set to Initialize all and Off when it is set to Initialize all except communication settings.
- 6 You can set this when a PID control module is detected. Release number 4 and later.

Security settings

Set this to **On** to initialize the security settings.

Control settings

Set this to **On** to initialize control settings.

Setup items that are initialized

- Control settings
- Program pattern settings
- Control event action

Other

Set this to **On** to initialize settings other than the security and control settings.

If you change this from **Off** to **On**, Communication(IP address), Communication(Server settings), Calibration correction settings, and Instruments tags, etc. are also set to **On**.

Communication(IP address)

Set this to **On** to initialize the IP address, DHCP, and DNS settings.

Communication(Server settings)

Set this to **On** when you want to initialize the server list settings, server encryption settings, and channel conversion setting of DARWIN compatible communication.

Calibration correction settings

Set this to **On** to initialize calibration correction settings and calibration reminder settings (/AH option).

Instruments tags, etc.

Set this to **On** to initialize tag settings and the ID setting of Bluetooth communication.

Data

Setup Item	Selectable Range or Options	Default Value
Internal Data *	Off, On	Off

* You can set this when Initialize is set to Separate. This is fixed to **On** when Initialize is set to Initialize all or Initialize all except communication settings.

Internal data

Set this to **On** to initialize all data in the internal memory.

Note

- Before initializing, back up necessary setup parameters and other data.
 - ▶ See page 2-192 in section 2.28.1, "Saving, Loading, and Deleting GM Setting Parameters".
- Initialization does not initialize the A/D calibration password.

If you forget the password, you will not be able to perform A/D calibration. Make sure you do not forget the password.
- If you perform initialization by selecting **Initialize all** or **Communication(IP address)**, the Web application connection will be disconnected as a result of the IP address being initialized. If this occurs, use the SMARTDAC+ IP Address Configurator to reassign the IP address.
 - If Communication of the security function is set to Login and you initialize the IP address, you cannot set the IP address with the IP Address Configurator. For details on how to set the IP address in this situation, see the IP Address Configurator User's Manual (IM 04L61B01-03EN).
- If the communication is disconnected due to initialization, do not close the browser, refresh the Web browser, or change the URL until the communication status icon turns off. Doing so may cause the closing of the browser or refreshing of the Web page to take a long time.

Description

Channel Assignment in Group Settings through Initialization

If you initialize, channels will be automatically assigned on the basis of the installed modules. If necessary, change the channel assignments for your purpose.

Initialized Settings depending on Initialization Items

Setting/Internal memory	Description	Initialization item						
		Initialize all	Initialize all except communication settings	Security settings	Control settings	Other	Internal data	
Security settings	Security values	Yes	—	Yes	—	—	—	
	Bluetooth password setting							
Control settings	See control setting details.	Yes	—	—	Yes	—	—	
Other	Communication(IP address)	Automatic IP settings	Yes	Yes	—	—	Yes	
		Automatic DNS settings						
		Host name registration settings						
		IP address settings						
		DNS settings						
		Domain suffix settings						
		Host settings						
	Communication (Server settings)	Server list settings	Yes	Yes	—	—	Yes	—
	Calibration correction settings	Calibration correction settings (excluding control settings)	Yes	—	—	—	Yes	—
	Instruments tags, etc.	Instruments tag settings	Yes	—	—	—	Yes	—
Bluetooth communication ID setting								
Internal data	Control alarm summary	Yes	—	—	—	—	Yes	
	Control summary							
	Alarm summary							
	Message summary							
	Memory summary (display and event data)							
	Measurement data							
Log data	Event log	Yes	—	—	—	—	—	
	Error log							
	FTP log							
	Mail log							
	Modbus							
	Health monitor log							
Display information	Free message settings	—	Yes	—	—	Yes	—	
Internal file	Report file	Yes	—	—	—	—	—	
	Favorite monitors data							
	Pattern file (1 to 99)							
	Predictive detection model							
	Profile trend							

Control setting details

Item		
Control settings	Setup parameters	Basic control settings (control settings, contact registration, relay related)
		I/O settings
		PV, RSP settings
		OUT settings
	Operation parameters	Control alarms
		Target setpoints
		PID number/Reference point
		PID settings
		Control detail setting
Control display	Control group settings	
	Loop display settings	
	Screen display settings	
Program pattern settings	Program Run/Reset message Automatic switch to program operation display Program RUN detail settings	
Control event action	DI/DO/Internal switch registration	

* The following control settings are not initialized. They are initialized when **Initialize all** is specified or when **Others** is set to **On**.

Item

PID channel settings of control display
Math channel formula

2.29.2 Initializing Display Groups or Recording Channels Separately

You can initialize display groups or recording channels separately.

When the measurement mode is Dual interval, channels will be automatically assigned on the basis of the installed modules. If necessary, change the channel assignments for your purpose.

Path

Web application: **Option** tab > **Initialize** > **Individual settings**

Description

Setup Item	Selectable Range or Options	Default value
Display group settings	Off, On	Off
Recording channel settings	Off, On	Off

Display group settings

Set this to On to initialize display group settings.

Recording channel settings

Set this to On to recording channel settings.

2.29.3 Setting the Measurement Mode

The measurement mode determines how the entire GM system operates. The GM measurement characteristics change depending on the measurement mode. The measurement mode must be set before reconfiguration and before specifying various settings.

Depending on the measurement mode, there are limits to the modules that can be used, the number of measurement channels and recording channels, and so on. For limitations, see the *GM Data Acquisition System General Specifications* (GS 04L55B01-01EN).

Path

Web application: **Calib** tab > **Measurement mode**

Description

Setup Item	Selectable Range or Options	Default value
Measurement mode	Normal, High speed, Dual interval	Normal

Measurement mode

Set the measurement mode according to the measurement conditions.

Options	Description
Normal	Data collection (measurement and recording) can be performed at 100 ms minimum.
High speed	Data collection (measurement and recording) can be performed at 1 ms minimum.
Dual interval	Data collection (measurement and recording) can be performed at two different scan intervals.

Note

- When the measurement mode is changed, the system restarts, and the following data is initialized. Set the measurement mode before reconfiguration and before specifying various settings.

Initialized settings

All internal data

All setting parameters including security settings but excluding communication settings

System configuration data

- You cannot set the measurement mode when recording, computation, or control execution is in progress.
- The measurement mode setting is not initialized through the initialization of settings.
- Measurement mode setting is not saved in setting parameter files.
- If the advanced security function (/AS) or multi-batch function (/BT) is enabled (On), the measurement mode is fixed to Normal. To change the measurement mode, set the advanced security function (/AS) and multi-batch function (/BT) to off.
- When the login function is in use, only system administrators can set the measurement mode.

Description

By switching the measurement mode according to the measurement target and measurement conditions, you can perform high-speed measurements as well as simultaneous high-speed and low-speed measurements.

In high-speed measurement, a high-speed AI module can be installed to achieve measurement at the shortest interval of 1 ms.

In dual interval measurement, measurement can be performed by two measurement groups with different scan intervals.

2.29.4 Reconfiguring the GM

When you reconfigure the GM, the I/O modules installed in the main unit and sub units are detected, and the settings are changed accordingly.

Reconfiguration is necessary in the following situations.

- When you change the modules (change to different modules)
- When you add or remove modules
- When you connect or add a sub unit
- When the measurement mode is changed
- When the advanced security setting on/off state is changed

Path

Web application: **Calib** tab > **Reconfiguration**

Hardware configurator: **Operation** tab > **Reconfiguration**

Procedure

- 1 Click **Reconfiguration**.
A Reconfiguration dialog box appears.
A message "Reconfigure modules?" appears.
- 2 Click **Execute**.
The GM will reconfigure.
A message "System reconstruction in progress" appears.
When reconfiguration is complete, a Hardware configuration dialog box appears.
- 3 Click **OK**.
The Hardware configuration dialog box appears again.
- 4 Click **OK**.

Note

- Do not carry out the following operations while a reconfiguration is in progress. Doing so may damage the GM.
Turn the power off and on.
Insert or remove modules.
- If turn off a expansion module and turn it back on, after checking the connected module, execute reconfiguration.
- Reconfiguration is not possible during recording or computing. Be sure to stop recording and computing beforehand.
- If the total number of I/O channels of the installed modules exceeds 100 on the GM-10-1 or 500 on the GM10-2, no additional modules can be detected.
For example, if the maximum number of I/O channels are assigned and the last channel is assigned to an intermediate channel of a module, that module (channel) and subsequent modules (channels) will not be reconfigured or recognized.

GM10-1

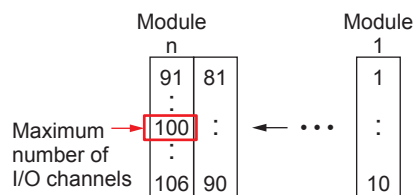

This module will not be detected.

- A single digital input/output module (GX90WD) can be linked to the main unit and each of the sub units.
- Up to a total of 10 digital output modules (GX90YD) and digital input/output modules (GX90WD) can be linked in a system.
- If the measurement mode is set to **High speed, Dual interval** or if the advanced security function is set to **On**, PID control modules (GX90UTs) will not be identified.
- When the measurement mode is **High speed**, modules other than high-speed universal type analog input modules, digital input modules, digital I/O modules, and network modules are not recognized. In addition, the digital input module and digital I/O module are fixed to remote mode with only one module. Measurement and recording are not possible.

- During reconfiguration, the output channel is turned off or de-energized. In addition, for models with the program control function (PG), the program pattern is changed when the PID control module is removed.

Conditions on the Combination of GM10 Versions and Input/output Modules

The module versions that can be detected depending on the GM10 version are as follows. If a module cannot be detected, update the GM10.

I/O Module and Expansion Module			GM10
Model	Type	Firmware version	Firmware version
GX90XA	-C1	R1.04.01 and later	R2.02 and later
	-L1	R1.04.01 and later	R2.02 and later
	-U2	R1.04.01 and later	R2.02 and later
	-T1	R1.04.01 and later	R2.02 and later
	-H0	R1.01.01 and later	R4.01 and later
	-R1	R1.01.01 and later	R4.01 and later
GX90XD	---	R1.04.01 and later	R2.02 and later
GX90XP	---	R1.01.01 and later	R3.01 and later
GX90WD	---	R1.04.01 and later	R2.02 and later
GX90YD	---	R1.04.01 and later	R2.02 and later
GX90YA	---	R1.01.01 and later	R3.02 and later
GX90UT	---	R1.01.01 and later	R4.01 and later
GX90NW	---	R1.01.01 and later	R5.02 and later
GX90EX	---	R1.02.01 and later	R2.02 and later

2.29.5 Notes on System Configuration



- Link modules with the unit's power turned off.
- Do not link modules in a way that violates the specifications. Doing so can cause the GM system to crash.
- When a system shutdown occurs, the GM10's 7 segment LED displays "bF."

Module Linking That Causes the GM to Shut Down

- When multiple data acquisition modules (GM10) are linked
- When a data acquisition module (GM10) is linked to a slot that is not adjacent to the power supply module (GM90PS)
- When an electromagnetic relay type or high-speed universal type analog input module is linked to slot 8 or 9 of the main unit
- When an electromagnetic relay type or high-speed universal type analog input module is linked to any of the slots from 0 to 7 of the main unit and a module is linked to slot 8 or 9
- When a high-speed universal type analog input module is linked to the main unit and an analog output module is linked to slot 7, 8, or 9
- When an analog output module is linked to the main unit and a high-speed universal type analog input module is linked to slot 7, 8, or 9
- When a high-speed universal type analog input module and an analog output module are linked to any of the slots from 0 to 6 of the main unit and a module is linked to slot 7, 8, or 9
- When multiple digital I/O modules are linked to the main unit
- When three or more analog output modules are linked to the main unit
- When a PID control module is linked to slot 5 to 9 of the main unit
- When a PID control module is linked to any of the slots from 0 to 4 of the main unit and an I/O module is linked to slot 5 to 9
- When an expansion module (GX90EX) is linked to slots 7, 8, or 9 of the main unit
- When a GX90XA or GX90YA is connected when a network module (GX90NW) is used, when a module is linked to slots 6 to 9

Problematic Module Linking

In the Main Unit

Problematic System Configuration	Process Performed during System Configuration
Exceeding the allowed number of modules in a unit ¹	Modules are not detected.
Connecting a unconnectable module ²	
Connecting a module with connection limitations ³	
Linked module error	

In a Sub Unit

Problematic System Configuration	Process Performed during System Configuration
Exceeding the allowed number of modules in a unit ¹	Modules are not detected.
Connecting a unconnectable module ²	
Connecting a module with connection limitations ³	
Link module error	
Expansion module (GX90EX) with an invalid unit number in the system configuration ⁴	

In a Single Unit System

Problematic System Configuration	Process Performed during System Configuration
Exceeding the maximum number of channels in a unit ⁵	Adjusted so that the number is equal to the maximum number of channels
Link the module to the left side toward the front of the network module (GX90NW)	Modules are not detected.

In a Multi Unit System

Problematic System Configuration	Process Performed during System Configuration
Overlapping unit number in a system	None of the overlapping units are not detected.
Connecting an unidentifiable sub unit	Only the unidentifiable is not detected.
Exceeding the maximum number of modules in a system ⁶	Modules are not detected.
Exceeding the maximum number of channels in a system ⁷	Adjusted so that the number is equal to the maximum number of channels

- 1 Main unit: Up to 10 input/output modules (up to 7 when including an expansion module (GX90EX)). Sub unit: Up to 6 input/output modules (up to 7 when including an expansion module (GX90EX)).
- 2 Input/output module whose version is earlier than 1.04.01, expansion module whose version is earlier than 1.02.01, or unknown module
- 3 2 or more digital input/output modules (GX90WD) in a unit. 11 or more digital output modules (GX90YD) or digital input/output modules (GX90WD) in a system. Main unit: Linking an expansion module (GX90EX) to a slot other than slots 0 to 6. Main unit: Linking an input/output module to the left as seen from the front of an expansion module (GX90EX). Sub unit: Linking an expansion module (GX90EX) to an improper position.
- 4 Other than unit numbers 1 to 6
- 5 Up to 100 channels
- 6 GM10-1: Up to 10 input/output modules. GM10-2: Up to 42 input/output modules.
- 7 GM10-1: Up to 100 channels. GM10-2: Up to 500 channels.

Problematic Unit Connection

- The system will not operate properly if units are connected in a ring.
- The system will not operate properly if there are multiple data acquisition modules (GM10) in a system.

2.30 Configuring Key Creation, Certificate Management, and Encryption/Certificate (SSL communication, PDF electronic signature)

Configure these settings when using SSL encryption and PDF electronic signatures. To use encryption on the FTP server and HTTP server and to use PDF electronic signature, you must create a key and install a certificate.

SSL (Secure Sockets Layer)

SSL is a function for encrypting data communication between devices on the Internet and other networks. It ensures safe data transmission such as by preventing spoofing by other devices and data eavesdropping.

Note

When the GM and Web application are being configured for SSL communication, once all the SSL communication settings are aligned, SSL communication will take effect, causing the communication between the GM and Web application to be disconnected.

In this situation, we recommend the following procedure.

- 1 Check that HTTP encryption is set to Off. If it is set to On, change it to Off (see section 2.30.1).
- 2 Change the encryption function to On (see section 2.30.1).
- 3 Check the presence or absence of a key. If there is none, create one (see section 2.30.2).
- 4 Check the presence or absence of a server certificate (communication). If there is none, create a self-signed certificate or install a server certificate (communication) (see section 2.30.3).
- 5 Change HTTP encryption to On. Check the HTTP port number (see section 2.30.4). The GM's HTTP port switches to SSL communication, and the communication with the Web application is disconnected.
- 6 Change the URL to https on the Web browser to reconnect (see section 2.1.4).

Note

When SSL communication is in progress between the GM and Web application, the following functions cannot be used.

- Create a key (see section 2.30.2)
- Create a self-signed certificate (see section 2.30.3)
- Install a certificate (see section 2.30.3)
- Install an intermediate certificate (see section 2.30.3)
- Delete a certificate (see section 2.30.5)

In addition, note the following points when turning off the SSL communication on the GM and the Web application.

- Before turning the SSL communication off, we recommend that you change HTTP encryption to Off (see section 2.30.4).
- If you change the encryption function to Off before turning off HTTP encryption, the HTTP port number will not be reset. As such, pay attention to the port number after switching back to normal HTTP communication. Normally, the HTTP port number is 80. The number during SSL communication is 443.

2.30.1 Enabling the Encryption Function

When you switch the encryption function on/off state, the GM will restart. After the GM restarts, you need to perform various configuration and operations.

Path

Web application: **Calib** tab > **Encryption/Certificate** > **Encryption function**

Description

Setup Item	Selectable Range or Options	Default Value
Encryption function	Off, On	Off

Encryption function

Select **On** to use the encryption function.

2.30.2 Creating a Key

Path

Web application: **Calib** tab > **Encryption/Certificate** > **Create a key**
 * Appears when the encryption function is set to **On**.

Procedure

- When switching to key creation mode, the GM restarts. When this happens, if the GM is configured to obtain the IP address automatically, the IP address may change after restarting, preventing the Web application from connecting to the GM.
- We recommend that you use a fixed IP address for communicating when switching to key creation mode.

1

Click **Create a key**.
 A Create a key dialog box appears.

2

Click **Execute**.
 The Create a key dialog box closes. The GM switches to key creation mode and starts creating a key.
 When the process is complete, the Create a key dialog box appears.

3

Click **OK**.
 The GM restarts and switches to normal mode.

Operation complete

Note

- Clicking **Cancel** while a key is being created (key creation mode) opens a Create a key dialog box.
 Clicking **OK** will cancel the key creation.
 Clicking **Cancel** will continue the key creation.
- If you perform any of the following operations, a special standby screen for key creation mode will appear with message M8205.
- If you press Refresh on the Web browser while a key is being created
 - If a connection is made to the GM10 while a key is being created
 - While using the Web application, key creation is executed from a Web application of another Web browser
- Keys cannot be created with a User connection.

Description

Setup Item	Selectable Range or Options	Default Value
Key	—	—

Key

Displays the presence or absence of a key.

2.30.3 Configuring Certificate Management (Creating self-signed certificates, creating certificate signature requests (CSRs), installing certificates, and installing intermediate certificates) and Deleting Certificates

Path

Web application: **Calib** tab > **Encryption/Certificate** > **Certificate management**
 * Appears when the encryption function is set to **On**.

Description

Execution Button	Description
Open folder	Opens the folder selected from the list.
Certificate Exist/Not exist	Displays certificate information with installed certificate status.
View certificate	Displays the content of installed certificates or deletes certificates.
Creating a self-signed certificate	Creates and installs a self-signed certificate.
Creating a certificate signing request (CSR)	Creates on an external medium a certificate signature request (CSR) to be submitted to a certification authority and the serial number indication of the device information.
Installation of certificate	Installs a certificate from an external medium.
Installation of intermediate certificate	Installs an intermediate certificate from an external medium.
Reload	Reloads the medium status.
Delete	Deletes the selected file.

Certificate Exist/Not exist

Certificate for Communication

Displays the presence or absence of a certificate for communication.

Certificate for PDF signature

Displays the presence or absence of a certificate for PDF signature.

View certificate

In a loaded dialog box, the details of the file name of the selected certificate and the serial number of the device information are displayed. The certification information is as follows.

Item
File name
Updated
Issuer
Valid not before
Validity not after
Front half of hash value (SHA1)
Latter half of hash value (SHA1)

Delete displayed certificate button

The File dialog box for confirming the file deletion appears.
 Clicking **OK** will delete the selected certificate file.

Updated

Displays the update time of the selected file.

Issuer

Displays the issuer information.

Subject

Displays the subject information.

Valid not before

Displays the start date of the valid period.

Validity not after

Displays the end date of the valid period.

Front half of hash value (SHA1)

Displays the front half of the certificate’s hash value.

Latter half of hash value (SHA1)

Displays the latter half of the certificate’s hash value.

Creating a self-signed certificate

Set the items in the self-signed certificate dialog box and click Execute to create and install a self-signed certificate. The setup items are shown below.

Setup Item	Selectable Range or Options	Default Value
Country	Character string (up to 2 characters, Aa)	—
State	Character string (up to 64 characters, Aa#1)	—
City	Character string (up to 64 characters, Aa#1)	—
Common name	Character string (up to 64 characters, Aa#1)	—
Organization	Character string (up to 64 characters, Aa#1)	—
Organization unit	Character string (up to 64 characters, Aa#1)	—
E-mail	Character string (up to 64 characters, Aa#1)	—
Use	Communication, PDF signature	Communication

Country

Set the ISO country code. (United States country code: US)

State

Set the state.

City

Enter the city name.

Common name

Set the URL (FQDN) of the site that will use SSL encrypted communication. This must match the URL that the clients specify to establish SSL connection.

Organization

Set the official English name of the organization that will manage the server. Enter the official organization name including the suffix such as inc., Co.ltd, K.K.

Organization unit

Set the division, department, or other names for identification.

E-mail

Set the E-mail address.

Use

Set the use of the self-signed certificate.

Creating a Certificate Signature Request (CSR)

To apply and obtain a certificate, create a certificate signature request (CSR) to be submitted to a certification authority.

Set the items in the Creating a self-signed certificate dialog box and click Execute to create a certificate signature request (CSR) and save it to the GM's external medium.

You need to enter a file name before clicking Create. When you are setting the file name, selecting **Certificate Signing Request file (*.CSR)** for the file type will display certificate signature request files that are already present.

Setup Item	Selectable Range or Options	Default Value
Country	Character string (up to 2 characters, <input))<="" td="" type="text" value="Aa"/> <td>—</td>	—
State	Character string (up to 64 characters, <input))<="" td="" type="text" value="Aa#1"/> <td>—</td>	—
City	Character string (up to 64 characters, <input))<="" td="" type="text" value="Aa#1"/> <td>—</td>	—
Common name	Character string (up to 64 characters, <input))<="" td="" type="text" value="Aa#1"/> <td>—</td>	—
Organization	Character string (up to 64 characters, <input))<="" td="" type="text" value="Aa#1"/> <td>—</td>	—
Organization unit	Character string (up to 64 characters, <input))<="" td="" type="text" value="Aa#1"/> <td>—</td>	—
E-mail	Character string (up to 64 characters, <input))<="" td="" type="text" value="Aa#1"/> <td>—</td>	—

Country, State, City, Common Name, Organization, Organization Unit, and E-mail

These items are the same as those explained in "Creating a Self-Signed Certificate."

Installation of certificate

Set the file type to **Certificate file (*.CER)** to display a list of certificate files. Select the file that you want to install, and click **Installation of certificate**.

An Installation of certificate dialog box appears.

Select the use and click Execute to install it.

Setup Item	Selectable Range or Options	Default Value
Use	Communication, PDF signature	Communication

Use

Set the use of the certificate.

Installing an Intermediate Certificate

Like the installation of a certificate, select the file that you want to install, and click

Installation of intermediate certificate.

An Installation of intermediate certificate dialog box appears.

Select the use and click Execute to install it.

Setup Item	Selectable Range or Options	Default Value
Use	Communication, PDF signature	Communication

Use

Set the use of the certificate.

2.30.4 Configuring the Encryption of the Server Function and Client Function, and Applying PDF Electronic Signatures

Configuring the Server Function

Set the encryption of the FTP server and HTTP server.

- ▶ For details on the settings, see page 2-156 in section 2.22.2, “Configuring the FTP Client Function” and page 2-158 in section 2.22.3, “Configuring the SMTP Client Function”.

Configuring the Client Function

Set the encryption of the FTP client and SMTP client.

- ▶ For details on the settings, see page 2-124 in section 2.17.1, “Setting the Report Type, Creation Time, Data Type, Etc.”.

Setting the PDF Electronic Signature

Set the electronic signature of PDF files.

- ▶ For details on the settings, see page 2-168 in section 2.22.9, “Setting the Server Functions to Use (FTP, HTTP, SNTP, MODBUS, GENE, DARWIN compatible communication)”.

2.30.5 Loading, Deleting, and Saving a Trusted Certificate

- ▶ See page 2-198 in section 2.28.5, “Saving, Loading, and Deleting Trusted Certificates”.

2.30.6 Verification Confirmation of Unverified Certificates

If a certificate that you have fails verification and FTP transfer or mail transmission is not possible, an error message (E782 or E783) appears, and a **Unverified certificate** appears on the **Operation** tab.

FTP transfer or mail transmission will not be possible until a verification confirmation is performed, a root certificate is installed, or other appropriate measure is taken.

When verification confirmation is performed, transmission becomes possible, and data that was not transmitted will be transmitted in the next transmission opportunity.

- 1** On the **Operation** tab, click **Unverified certificate**.
An Unverified certificate dialog box appears.
- 2** Select (click) the server that you want to display the certificate information of.
A Select unverified certificate dialog box appears with the certificate information. You will be prompted to install a root certificate or confirm the certificate.
- 3** Check the information, and click **OK**.
Clicking **Cancel** will abort the process and close the dialog box.

Certificate Information

Item	Description
Type	FTP Primary, FTP Secondary, SMTP
Validity	OK or not OK
Verification	OK or not OK
Issuer	Name of the issuer
Subject	Subject
Valid not before	Start date and time of validity
Validity not after	End date and time of validity
Front half of hash value (SHA1)	Front half of hash value
Latter half of hash value (SHA1)	Latter half of hash value

2.31 Using the DARWIN Compatible Communication Function

This section provides an outline on how to use the DARWIN compatible communication function and how to configure it.

2.31.1 Overview

A portion of the DARWIN's setting and control commands is supported. Measured data, math data, and so on can be output in DARWIN format. You can use an existing program that has been created for DARWIN to communicate with the GM.

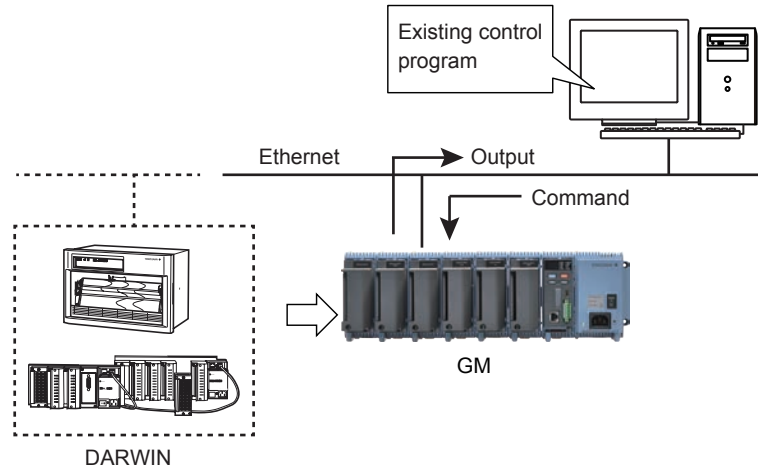

Note

- The following application programs and API are not supported. You cannot communicate with the GM using the following programs and API through the DARWIN compatible communication function.
- DAQ32, DAQ32Plus, DAQLogger
 - MX190 (API for MX100/DARWIN)
 - LabVIEW driver (for DARWIN)

Instrument Configuration

To control the GM using the DARWIN compatible communication function, you must configure the GM (module type, channel numbers (unit numbers and slot numbers)) to match DARWIN.

For details on channel conversion, see page 2-168 in section 2.22.9, "Setting the Server Functions to Use (FTP, HTTP, SNTP, MODBUS, GENE, DARWIN compatible communication)" (for Ethernet communication) or page 2-172 in section 2.23.1, "Setting Basic Communication Conditions" (for serial communication).

Module Configuration Example

Unit	DARWIN (Extended type)	GM
Main unit	Main	Main unit
Slots 0 to 5	—	No module
Sub unit	DS600	Sub unit
Slot 0	DU100-11	GX90XA
Slot 1	DU100-11	GX90XA
Slot 2	DU100-11	GX90XA
Slot 3	No module	No module
Slot 4	DU100-11	GX90XA
Slot 5	No module	No module

Interface

Ethernet, RS-422/485 (/C3 option)

Communication Ports and Maximum Number of Connections (for Ethernet)

Port Number	Maximum Number of Connections	Notes
34150	1	RS232C command support, configuration port
34151	4	Loading instantaneous data

- Port 34159 (communication status verification) cannot be used.

Connection Limitation (Release number 3 (Version 3.02) and later)

- Connection can be limited using the port limitation setting command (SDarwinPortLimit).
- When port limitation is on, the limitation is the same as that of DARWIN. When connected via Ethernet, only instantaneous data reading is possible on port number 34151. Configuration, control, and operation are not possible. When connected via serial, only the commands that can be used on a Ethernet connection through port 34150 are valid.
- When port limitation is off (default value), there are no limitations on commands on either port. All supported commands work on both ports.
- For details on communication commands, see the Communication Interface User's Manual (IM 04L51B01-17EN).

Terminator

Classification	Terminator
Input	CR+LF or LF
Output	CR+LF

Limitations

- If communication security is enabled in security settings, you must login via communication. For details about logging in through communication, see the communication control commands in the Communication Command Manual.

Procedure to Use the GM

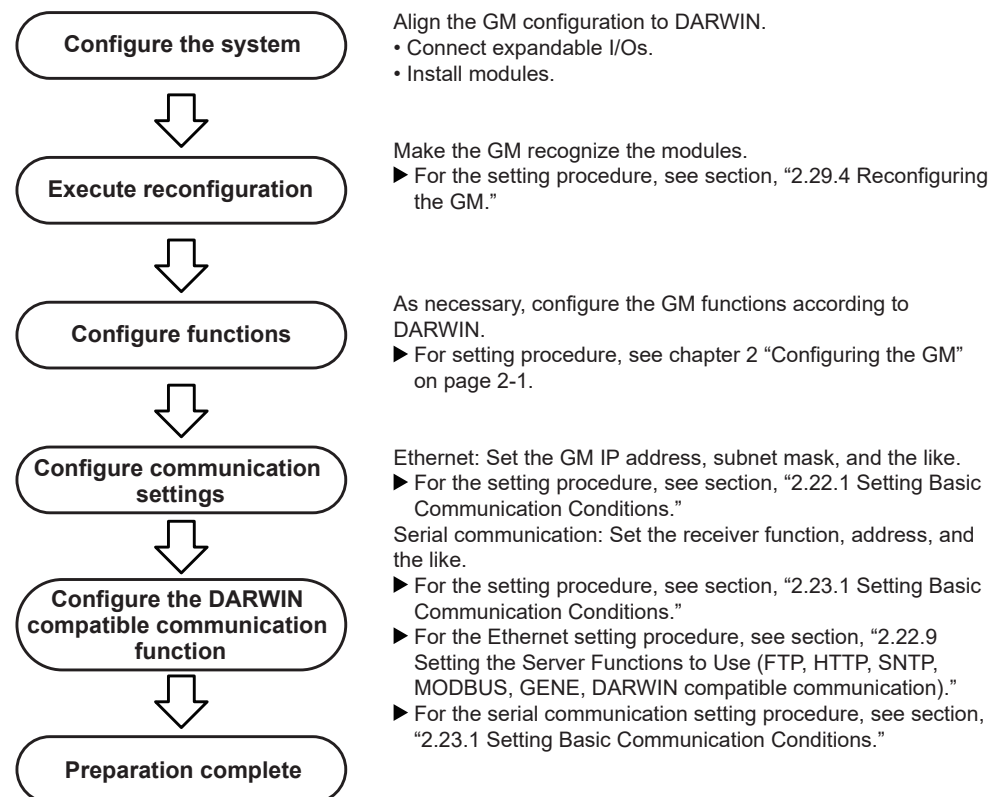

2.31.2 Supported Commands

The commands supported by the DARWIN compatible communication function are as follows.

Instantaneous Data Output Commands

Command	Description
EF	Outputs measured data and math data in binary format.
EL	Outputs unit and decimal point information of a specified channel in ASCII format.
EB	Sets the byte output order.

DO, DIO, AO, and PID control modules cannot output measured data or decimal point information.

ESC+T Command

If a "Esc+T" command is received, time-synchronized measured value and math value are held in the local buffer until the next "Esc+T" command is received.

Command	Description
Esc+T	Prepares to output the data selected with the TS command.

Setting Commands

Command	Description
SR	Sets the range.
SN	Sets the unit (scale unit).
SA	Sets an alarm.
SD	Sets the date and time.
SV	Sets moving average.
CM	Sets math input data (option).
SC ^{1,3}	Sets the chart speed.
SZ ^{1,3}	Sets the zone recording.
PT ^{1,3}	Sets the analog recording.
AO ^{1,2}	Assigns a reference channel to the retransmission output channel

- 1 Release number 4 and later
- 2 Setting a channel set to manual output will result in error.
- 3 Only an affirmative response is returned on the GM because this is not supported.

SR Command Parameters

If a setting parameter that the GM does not support is received, a negative response is returned.

Item	Description
Mode	RRJC
Range	PT2, JPT2, PT2S, JPT2S, GATE
Module	AC, STRAIN

- When the mode is SCL
Sending a command without a parameter may cause an E1 error.
If an error occurs, do not omit the parameters.
- When the mode is PULSE
Setting is not possible with just the SR command. Set the range setting data type to scaling, and then send the command.

Commands Applicable to RS-422/485 Only

Command	Description
Esc+O	Open Command (address a communication destination)
Esc+C	Close Command (close the addressed state of a device)

Data Output Request Commands

Command	Parameter	Description
TS	0: Measured data	Selects the talker output data.
	1: Setting parameters	
	2: Unit information	
	5: System configuration information	
	9: Setup mode setting data output	
FM	0: Measured data (ASCII)	Selects the output format of measured/math data.
	1: Math data (binary)	
	2: Math data (ASCII)	
	3: Math channel (binary)	
LF	—	Sets the output channel for the setting data output, unit, and decimal place information.
CF	—	Sets the system configuration data format.
VF	—	Relay status output request
BO	—	Sets the byte output order.
Esc+S	—	Status output request

Responses to Output Request Commands

AO module channels are not output in response to the following command.

Command	Item
FM	Selects the output format of measured/math data.
EF	Measured data and math data (binary format)
LF	Sets the output channel for the unit and decimal place information.
EL	Unit and decimal point information of a specified channel (ASCII format)

Module Names Output by the CF Command

GM Module	Module Name
AI module	INPUT
DI module	DI
DO module	RELAY
Expansion module	Module not connected
Module error	XXXXXX
DI/DO module	REMOTE
AO module	OUTPUT
PID control module	PID
Network module	COMM

Control Execution Commands

Command	Description
AR	Resets alarms.
IR	Resets timers.
EX	Starts, stops, resets, clears (option) math.
RS	System reconfiguration
RC	Clears RAM (initializes operation mode setting parameters).
VD	Turns on and off relays externally.
CF	System configuration data output request (diagnosis)
PS	Starts or stops recording.
MS	Starts message printing.
IM	Sets the interrupt mask.
SM	Sets the auxiliary interrupt mask.

Handling of Commands for Functions Not Available on the GM

If a command or parameter for a function not available on the GM is received, a negative response (E1) is returned.

However, if the command does not constitute a functional problem, a positive response (E0) is returned without performing any operation.

Commands That the GM Returns Positive Responses For

Command	Description	Response	Operation
DS	Switches the setting mode.	Positive response	No operation
XE	Confirms setup setting parameters.		
UD	Sets the display mode of the top display.		
ESC+R	Switches from local mode to remote mode.		
ESC+L	Switches from remote mode to local mode.		

Commands That Do Not Affect the Operation (Negative response)

Command	Description	Response	Operation
SX	Sets a math group.	Negative response	No effect
SI	Sets a timer (option).		
SQ	Sets a match time timer (option).		
SL	Sets event/action (option).		
SO	Sets a calculation expression (option).		
SK	Sets a calculation constant (option).		
AO	Assigns a transmission channel.		
YO	Sets the time constant for transmission output.		
ET	Sets a timeout.		

If ASCII codes E2 to E6 (Ω , μ , ϵ , υ) are received, they are converted to spaces, and no error results. The E1 character ($^{\circ}$) is converted to the GM character code C2B0 and applied.

Setting Output Format

When you execute the command TS1 + device trigger (ESC+T) + LF, the operation mode parameters are output in the following order.

SR	Measurement range setting data of the first channel	CrLf
•	•	•
•	•	•
SR	Measurement range setting data of the last channel	CrLf
SN	Unit setting data of the first channel	CrLf
•	•	•
•	•	•
SN	Unit setting data of the last channel	CrLf
SA	Alarm setting data of the first channel	CrLf
•	•	•
•	•	•
SA	Alarm setting data of the last channel	CrLf
SV	Moving average setting data of the first channel	CrLf
•	•	•
•	•	•
SV	Moving average setting data of the last channel	CrLf
AO	Retransmission output setting data of the first channel	CrLf
•	•	•
•	•	•
AO	Retransmission output setting data of the last channel	CrLf
EN	Output end	CrLf

Because the command TS9 + device trigger (ESC+T) + LF is not supported, only the EN line will be output.

Command Operation When the Multi Batch Function (/BT) Is Enabled (Release number 3 and later)

This section explains the operation of the following commands when the multi batch function is enabled.

Command	Description
PS	Starts/stops recording of the first batch
EX	Starts, stops, resets, clears computation
MS	Writes a message to all groups in the first batch

Handling of Commands for Functions Not Available on the GM

If a command or parameter for a function not available on the GM is received, a negative response (E1) is returned.

However, if the command does not constitute a functional problem, a positive response (E0) is returned without performing any operation.

Commands That the GM Returns Positive Responses For

Command	Description	Response	Operation
DS	Switches the setting mode.	Positive	No operation
XE	Confirms setup setting parameters.	response	
UD	Sets the display mode of the top display.		
SC	Sets the chart speed.		
SZ	Sets the recording zone.		
PT	Sets the analog recording on/off state.		
ESC+R	Switch from Local Status to Remote Status.		
ESC+L	Switch from Remote Status to Local Status.		

Commands That Do Not Affect the Operation (Negative response)

Command	Description	Response	Operation
SX	Sets a math group.	Negative	No effect
SI	Sets a timer (option).	response	
SQ	Sets a match time timer (option).		
SL	Sets event/action (option).		
SO	Sets a calculation expression (option).		
SK	Sets a calculation constant (option).		
YO	Sets the time constant for transmission output.		
ET	Sets a timeout.		

If ASCII codes E2 to E6 (Ω , μ , ε , ν) are received, they are converted to spaces, and no error results. The E1 character ($^{\circ}$) is converted to the GM character code C2B0 and applied.

Handling depending on the Measurement Mode

Measurement mode	Description
Normal	All the channels of detected modules are output (except for DO, DIO, AO, and PID modules).
High speed	Of the detected modules, only the AI channels are output.
Dual interval	Of the detected modules, only the channels of scan groups using the master interval are output (except for DO, DIO, AO, and PID modules).

Command That Runs When the Measurement Mode Is Set to Dual Interval

Command	Description
EX	Starts, stops, resets, clears computation (master interval).
PS	Starts, stops recording of both measurement group 1 and 2.
MS	Writes messages to all display groups.

Handling of Settings Available on the GM but Not on DARWIN

Settings that are available on the GM but not on DARWIN are output as follows.

Command	Item	Description
SR	High-speed AI module's voltage (VOLT) at 100 V range	100V
	4-wire RTD module's RTD at PT500 range	Pt500
	4-wire RTD module's RTD at PT1000 range	Pt1000
	4-wire RTD module's type is resistance (OHM)	OHM
	4-wire RTD module's resistance (OHM) at 20 ohm range	20ohm
	4-wire RTD module's resistance (OHM) at 200 ohm range	200ohm
	4-wire RTD module's resistance (OHM) at 2000 ohm range	2000ohm
	AI module's general signal	GS
AO	DO module's PULSE	DIPULSE
	When the type is manual output	ManualAO

2.31.3 Configuring the DARWIN Compatible Communication Function

Ethernet

Path

Web application: **Config. tab > Communication (Ethernet) settings > Server settings**

Server list

Hardware configurator: **Communication (Ethernet) settings > Server settings Server list**

Description

DARWIN

Setup Item	Selectable Range or Options	Default Value
On/Off	Off, On	Off
Channel conversion*	Stand-alone type, extended type	Stand-alone type

* You can set this when the On/Off settings is set to **On**.

On/Off

Select **On** to use the DARWIN compatible communication function.

Channel Conversion

Set the DARWIN type to perform channel conversion.

Serial Communication

Path

Web application: **Config. tab > Communication (Serial) settings > Serial basic settings**

Hardware configurator: **Communication (Serial) settings > Serial basic settings**

Description

DARWIN

Setup Item	Selectable Range or Options	Default Value
Channel conversion*	Stand-alone type, extended type	Stand-alone type

* You can set this when the receiver function is set to **DARWIN**.

Channel Conversion

Set the DARWIN type to perform channel conversion.

2.31.4 Configuring the GM IP Address, Subnet Mask, and the Like (for Ethernet)

▶ See page 2-154 in section 2.22.1, "Setting Basic Communication Conditions".

2.31.5 Setting the GM's Basic Serial Communication Conditions (for RS-422/485)

▶ See page 2-172 in section 2.23.1, "Setting Basic Communication Conditions".

2.32 Using the Aerospace Heat Treatment (/AH option) (Release number 3 and later)

This section explains calibration reminder settings for periodically performing calibration correction settings and the like.

- When the notification date set using the calibration reminder function arrives, the notification content is shown on a notification screen.
- It can be used to remind you of the schedule.
- For details on calibration correction of AI channels, see page 2-43 in section 2.3.4, “Setting Calibration Correction (Linearizer approximation, linearizer bias, Correction factor* (release number 3 and later))”.
- For details on calibration correction of communication channels, see page 2-152 in section 2.21.4, “Setting Calibration Correction (Linearizer approximation, linearizer bias, Correction factor* (release number 4 (version 4.02) and later))”.
- For details on the calibration correction of the PID control module’s input terminal (AI number), see section 3.4.5, “Performing Calibration Correction,” in the Loop Control Function, Program Control Function (/PG Option) User’s Manual (IM 04L51B01-31EN).

2.32.1 Setting the Calibration Reminder

Path

Web application: **Config**. tab > **Calibration reminder settings**
 Hardware configurator: **Calibration reminder settings**

Description

Setup Item	Selectable Range or Options	Default Value
Schedule number	GM10-1: 1, 2, 3, 4, 5, 6 GM10-2: 1, 2, 3, 4, 5, 6, 7, 8, 9, 10, 11, 12	—
On/Off	Off, On	Off

On/Off

Set this to **On** to set a schedule.

Due date

Setup Item	Selectable Range or Options	Default Value
Due date	January 1, 2001 to December 31, 2035	January 1, 2012
Daily reminder	1 day before to 10 days before in unit of days	5 days before
Re-notification cycle	10min, 30min, 1h, 8h, 24h	1h

Due date

Set the reminder date by directly entering the date.

[+1 month] button/[-1 month] button: You can change the due date in unit of months.

[+1 week] button/[-1 week] button: You can change the due date in unit of weeks.

- If you change the due date with the buttons and the date that you select is not available in that month, the date is changed to the last date of that month (if you press [+1 month] button when the date is August 31, the date is changed to September 30).

Daily reminder

Set how many days before to start reminders using the notification screen.

Re-notification cycle

Set interval for showing reminders using the notification screen.

Notification contents

Setup Item	Selectable Range or Options	Default Value
Title	Character string (up to 32 characters, Aa#1)	—
Notification message 1	Character string (up to 32 characters, Aa#1)	—
Notification message 2	Character string (up to 32 characters, Aa#1)	—
Buzzer	Off, On	Off

Title

Set the title to show on the notification screen.

Notification message 1, 2

Set the notification contents.

Buzzer

Set this to On to sound the buzzer.

This depends on the PC's speaker settings.

Note

In Chrome, you have to click on the screen 1 or more times to play the alarm. To configure Chrome to play without having to click, do the following:

1. Type the following into the Chrome address bar and then press Enter.
chrome://flags/#autoplay-policy
2. Under Autoplay policy, select No user gesture is required.

2.32.2 Notification Screen Display

When a daily reminder date arrives, a notification screen appears at 00:00 (HH:MM).

This screen reappears at the re-notification cycle.

If the buzzer is enabled, a buzzer is sounded when the notification screen appears. To stop the buzzer, close the notification screen.

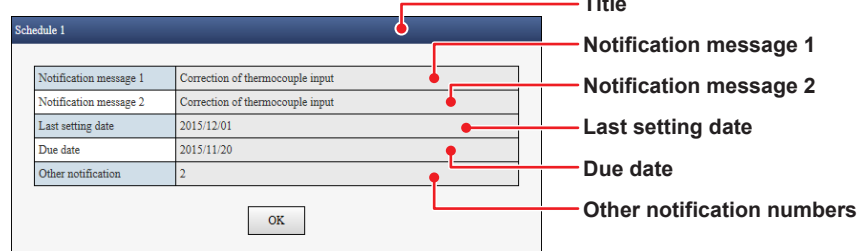
Notification screen**Operation Example**

Daily reminder setting: 1 (day before), re-notification cycle: 8h

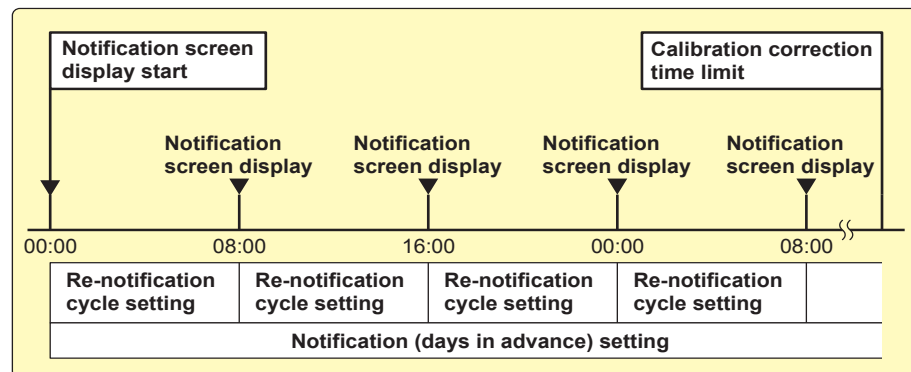



2.32.3 Displaying Reminders

Path

Web application: **Data** tab > **Reminder**

Description

Reminders that are currently valid are listed.
 The background color of each reminder varies depending on the elapsed time of the reminder.

Type: Reminder					
	No.	Title	Last setting date	Due date	Days remaining
	1	Calibration reminder A	2015/10/20	2015/11/18	-2 days
	2	Calibration reminder B	2015/10/20	2015/11/30	10 days
	3	Calibration reminder C	2015/10/20	2015/11/25	5 days
(1)	(2)	(3)	(4)	(5)	(6)

- (1) Indicates the reminder status with icon color.
 After the notification date but before the due date: Yellow
 After the due date: Red
- (2) Displays the schedule number of the registered schedule.
- (3) Displays the title of the notification screen.
- (4) Displays the date when the due date was set.
- (5) Displays the due date that was set.
- (6) Displays the number of days until the due date. A minus sign is displayed if the date is passed the due date. If the number of days exceeds 999, it is displayed as 999, including when the number is negative.

2.33 Configuring the Equipment/Quality Prediction (Release number 5 and later)

Set the health monitor function and profile function.

Operating conditions for the health monitor function and profile function

Item	Operating conditions	
	Health monitor function	Profile function
Required optional specifications	Off, On	Off
Multi-batch function (/BT option)*	None or disabled	None or disabled
Measurement mode	Normal	Normal:
Recording interval	---	500 ms or longer ¹
Event data recording mode	Free	Free

- ¹ When the recording interval is set to 200 ms or less, setting the profile waveform setting to **On** sets the recording interval to 500 ms or longer.

Required settings for using the health monitor and profile functions

In addition to the settings for equipment/quality early warning detection, please configure the following settings:

Health monitor function

Setup Item	Description	Reference
Recording channel	Assigns target channels to recording channels.	"Configuring Recording Channels" on page 2-111

Profile function

Setup Item	Description	Reference	
Recording channel	Assign target channel and profile channel (for advanced security function (/AS option)) to recording channel.	"Configuring Recording Channels" on page 2-111	
Alarm, profile channel	Sets the alarm of a target channel or profile channel.	AI channel	"Setting Alarms" on page 2-32
		DI channel	"Setting Alarms" on page 2-47
		Pulse channel	"Setting Alarms" on page 2-52
		Math channel	"Setting Alarms" on page 2-86
Communication channel ¹	Sets the communication channel to be set for the profile channel.	Communication channel	"Setting Alarms" on page 2-148
			"Configuring Communication Channels (/MC option)" on page 2-146

- ¹ To make it easier to compare to profile waveforms, we recommend aligning the upper and lower span limits of the communication channel with the target channel.

2.33.1 Predictive detection model and profile trend loading

Load the early detection models and profile waveforms in the external storage media into the GM.

There are the following four loading methods:

Loading method	Reference
Settings loading screen	"Saving and loading early warning detection models (Release number 5 and later)" in section 2.28.8 on page 2-204
	"Saving and loading profile trends (Release number 5 and later)" in section 2.28.7 on page 2-203
	"Saving and Loading Setting Parameters, Report Templates, Trusted Certificates, Program Patterns (/PG option) (Release number 4 and later), Profile Trend (/MC option)(Release number 5 and later), Predictive Detection Model (Release number 5 and later)" in section 2.28.4 on page 2-196
Event action	"Setting Event Action Numbers and Actions" in section 2.20.1 on page 2-135
Modbus	"Hold Registers (Shared with the Modbus server/slave function)" in section 4.5.5 on page 4-39
Communication command	Communication Command User's Manual (IM 04L51B01-17EN)

Event Actions, Modbus loading

The predictive detection model and profile waveform files must be saved to the SD memory card in the following folder and with the following file names.

File	Description
Predictive detection model	File name Model[.GDG []: 1 to 50 (Event action) 1 to 10000 (Modbus)
	Save destination Create and save a "Model" folder in the root directory.
Profile trend	File name Profile[.GPF []: 1 to 50 (Event action) 1 to 10000 (Modbus)
	Save destination Create and save a "Profile" folder in the root directory.

Note

- If the profile trend file is read during early warning detection, the profile trend is not written to the profile channel and no alarm is detected. Also, the current alarm is released. The next time the early warning detection starts, an alarm is detected in the newly loaded profile trend.
- If an early warning detection model file is loaded during the running of early warning detection, the early warning detection model is queued and becomes enabled when the next early warning detection starts. If loading is performed more than once, the last requested early warning detection model is enabled.
- If there is no GX/GP serial number in the early warning detection model file, it cannot be loaded. (Error message E216 appears)

2.33.2 Set the start and end conditions of the predictive detection section

This setting is common to the health monitor and profile functions.

The start and end of the predictive detection section is enabled when the recording starts.

When the recording stops, the predictive detection section ends regardless of the predictive detection section end condition.

Path

Web application: **Config. tab > Equipment/quality prediction > Basic settings**

Hardware configurator: **Equipment/quality prediction**

Description

Section setting for prediction

Setup Item	Selectable Range or Options	Default Value
Trigger	Threshold, Sync with recording, External signal, Repeat	Threshold

Trigger

Sets the type of trigger that starts and ends the early warning detection.

Selectable	Description
Threshold	Operate according to the threshold and conditions set for a specific channel
Sync with recording	Synchronize to recording start, recording stop
External signal	Event action, Modbus
Repeat	Repeat every specified number of data after starting

Reference channel

Setup Item	Selectable Range or Options	Default Value
Channel type	Off, I/O channel, Math channel, Communication channel	Off
Channel no	Channel number	—

Channel type

Sets the target channel for interval start and interval end conditions when the trigger type is threshold.

Channel no

Sets the channel number of the target channel.

Section start ¹

Setup Item	Selectable Range or Options	Default Value
Threshold	Reference channel span range ²	0
Condition	Or more, Less	—

¹ Appears when the trigger type is **Threshold**, and the reference channel is set to other than **Off**.

² When Rnage Calculation is set to **Linear scaling** or **Square root** in the input channel (AI/DI/Pulse), the range of scale -5 % to 105 %.

Threshold, Condition

Sets the threshold and conditions for the start of the predictive detection section.

Section stop ¹

Setup Item	Selectable Range or Options	Default Value
Threshold	Reference channel span range ²	0
Condition	Or more, Less	—

¹ Appears when the trigger type is **Threshold**, and the reference channel is set to other than **Off**.

² When Rnage Calculation is set to **Linear scaling** or **Square root** in the input channel (AI/DI/Pulse), the range of scale -5 % to 105 %.

Threshold, Condition

Sets the threshold and conditions for the start of the predictive detection section.

Note

If the early warning detection interval has not ended, the next early warning detection interval cannot be started. If the early warning detection interval has not ended, the early warning detection interval will automatically end when the number of recorded data points after the early warning detection interval has started reaches 30,000.
 Threshold-based condition judgment is performed when values exceed or fall below the threshold. If the values of the reference channel did not change since the previous judgment, the start/end processing of the section is not carried out.

Repeat ¹

Setup Item	Selectable Range or Options	Default Value
Starting condition	Record, External signal	Record
Number of data	20 to 30000	500

¹ You can set this when the trigger type is set to **Repeat**.

Starting condition

Selectable	Description
Record	Synchronizes to recording start.
External signal	Event action, Modbus

Number of data

Sets the amount of data to repeat.

2.33.3 Setting the health monitor function

Path

Web application: **Config**. tab > **Equipment/quality prediction** > **Health monitor settings**
 Hardware configurator: **Equipment/quality prediction** > **Health monitor settings**

Description

Section setting for prediction

Setup Item	Selectable Range or Options	Default Value
On/Off	Off, On	Off

On/Off

Select **On** * to use the health monitor function.

- * You cannot set the health monitor to **On** when the event data recording mode is not set to **Free**.
- * Judgment is performed with the display data when the recording data type is set to **Display + Event**.

▶ For details on the SMTP client settings, see page 2-158 in section 2.22.3, “Configuring the SMTP Client Function”.

▶ For details on the SMTP client settings, see page 2-159 in section 2.22.4, “Setting E-mail Transmission Conditions (When the SMTP client function is on)”.

Early notification

Setup Item	Selectable Range or Options	Default Value
On/Off	Off, On	Off
Early notification threshold	0.000 to 1.000	0

On/Off

Select **On** to use the early notification function*.

This is the trigger for event actions and email transmission.

- * Judgment is performed with the display data when the recording data type is set to **Display + Event**.

Early notification threshold

Sets the threshold at which an early notification is given.

Auto message

Setup Item	Selectable Range or Options	Default Value
Health monitor results	Off, On	On

Health monitor results

Set this to **On** to write messages of the health monitor results.

Selectable	Description
On	Write health monitor results (OK/NG, health score, predictive detection model file name) when the early warning detection interval ends. Display example: OK 0.981 Model.GDG ↑ ↑ ↑ Result Health Predictive detection model file name score
Off	Disables the function.

2.33.4 Setting the profile function

Path

Web application: **Config. tab > Equipment/quality prediction > Profile trend settings**
Hardware configurator: **Equipment/quality prediction > Profile trend settings**

Description

Setup Item	Selectable Range or Options	Default Value
On/Off	Off, On	Off

On/Off

Select **On**¹ to use the profile function².

- * You cannot set the profile trend settings to **On** when the event data recording mode is not set to **Free**.
- * Judgment is performed with the display data when the recording data type is set to **Display + Event**.

Note

When the recording period is set to 200 ms or less, you can set the profile trend settings to **On** to round the recording period to 500 ms or more.

Explanation

Equipment/quality early warning detection

Health monitor function

This function performs quality judgment based on the early warning detection model. You can see the health score, which is an indication of how normal or error. Early warning detection models are created with the equipment/quality early warning detection tool (sold separately, cloud or offline) based on historical measurement data.

Profile function

This function notifies the user of deviations from the profile waveform (upper and lower range of measured values) by an alarm. In addition, deviations from the reference waveform can be checked on the screen. Profile waveforms are created with the equipment/quality early warning detection tool (sold separately, cloud or offline) based on historical measurement data.

* The judgment results of equipment/quality early warning detection functions are reference information and do not guarantee performance or accuracy.

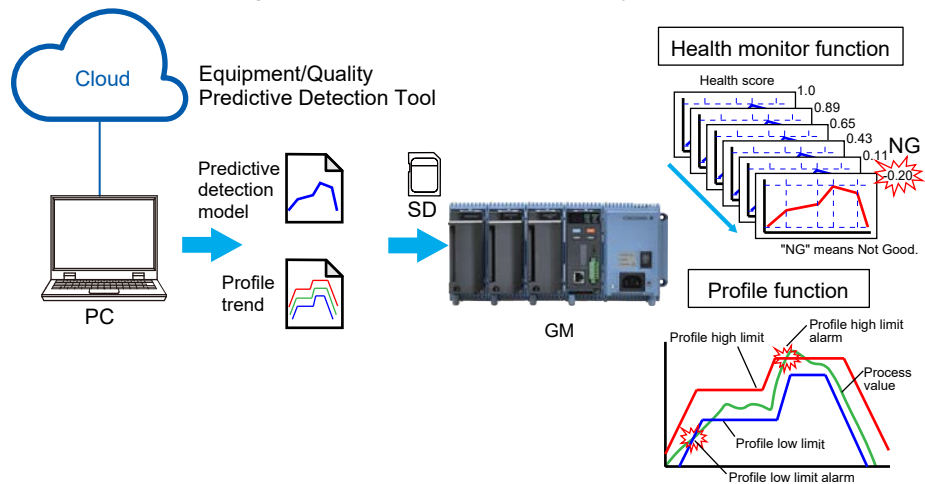

Profile alarm and profile channel for target channel (Profile function)**Procedure for setting profile trends**

Set the upper and lower profile alarms for the target channel.

Turn **On** the communication channels on which to load the profile trend.

If the advanced security function (/AS option) is enabled, also set the communication channels as recording channels.

On the alarm setting screen of the target channel, set the profile channel (communication channel) to load the profile trend (high limit, low limit, and reference value*).

*The reference value is only a display and alarm judgment is not available.

Example: To set a profile alarm on the target channel (0105) of the profile trend and load the upper limit, reference value, and lower limit of the profile trend into C001, C002, and C003:

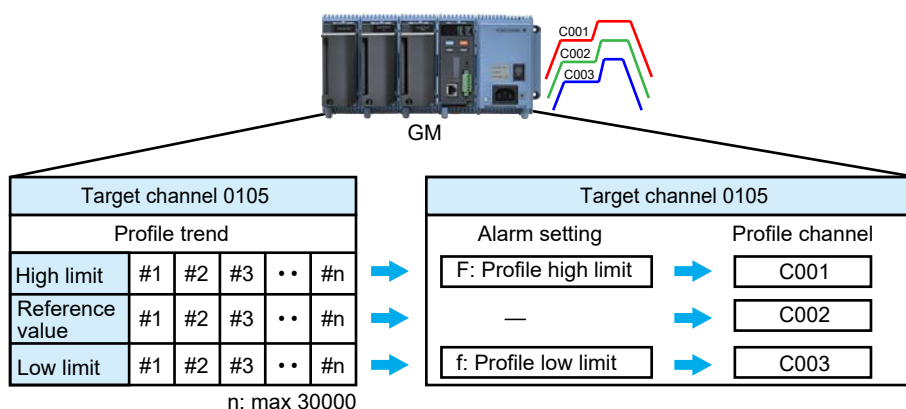
**Alarm detection using profile trend**

When the predictive detection section starts, the profile trend data is loaded into the profile channel and the alarm is detected.

When the profile trend data reaches the final value, loading into the profile channel and alarm detection stop.

Alarm detection is performed in the same manner as when the predictive detection section is terminated and the next predictive detection section is started.

2.34 Configuring the Network Module (Release number 5 (Version 5.02) and later)

- ▶ For details on configuring the PROFINET Communication, see the PROFINET Communication User's Manual (IM 04L51B01-22EN).

3.1 Controlling the GM

- ▶ For the details on the Web application screen, see “Screen” on page 2-6.
- ▶ If you are using the advanced security function (/AS option), see the Advanced Security Function User’s Manual (IM 04L55B01-05EN).

You can carry out the following operations on the Web application.

- Start and stop recording (▶page 3-2)
- Start, stop, reset, and acknowledge computing (▶page 3-3)
- AlarmACK (▶page 3-4)
- Individual alarm ACK (▶page 3-22)
- Set the date and time (▶page 2-23)
- Start, stop, and test mail transmission (▶page 3-43)
- Trigger the starting of event data recording (▶page 3-5)
- Execute manual sampling (▶page 3-5)
- Save event data (▶page 3-5)
- Save display data (▶page 3-5)
- Reset relative timers (▶page 3-6)
- Reset match time timers (▶page 3-6)
- Change a batch number, lot number, and batch comment (▶page 3-6)
- View the batch text (▶page 3-6)
- Change the time using SNTP (▶page 3-6)
- Perform a test print (▶page 3-7)
- Execute a file transmission test on the FTP server (▶page 3-7)
- Clear error displays (▶page 3-7)
- Clear the Bluetooth connection list (▶page 3-7)
- Save health monitor log (▶page 3-8)
- Control predictive detection section (▶page 3-8)
- Write messages (▶page 3-14)
- Change the alarm value (▶page 3-20)
- Change the DO channel output (▶page 3-20)
- Individual AO Channel Operation from the Monitor (▶page 3-21)
- Change the internal switch value (▶page 3-34)
- Change the login password (▶page 3-42)

Use the following buttons.

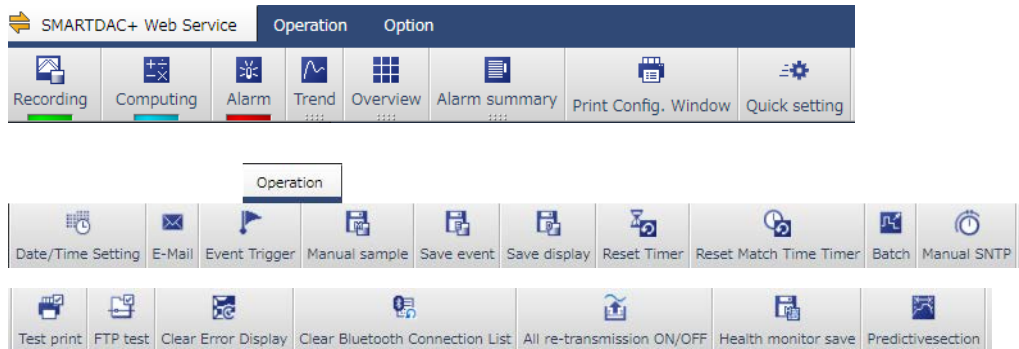

3.1.1 Starting and Stopping Recording

When the measurement mode is Dual interval, scan groups start and stop recording simultaneously.

Starting Recording

Follow the procedure below to start recording.

Procedure

- 1 On the **SMARTDAC+ Web Service** tab, click **Recording**. The Recording dialog box appears.
- 2 If the batch function is in use, enter numbers in the **Batch No.** and **Lot No.** boxes. You can also edit the text field by clicking **Edit Textfield**.

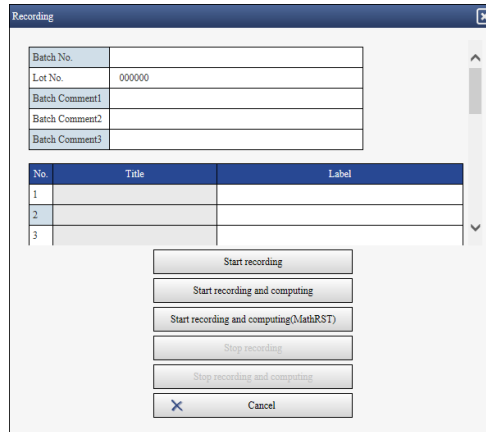

- 3 Click **Start recording** or **Start recording and computing**. Recording starts. The indicator below the **Recording** button turns on in green.



Stopping Recording

Follow the procedure below to stop recording.

Procedure

- 1 On the **SMARTDAC+ Web Service** tab, click **Recording**. The Recording dialog box appears.
- 2 Click **Stop recording** or **Stop recording and computing**. Recording stops. The indicator below the **Recording** button turns off.

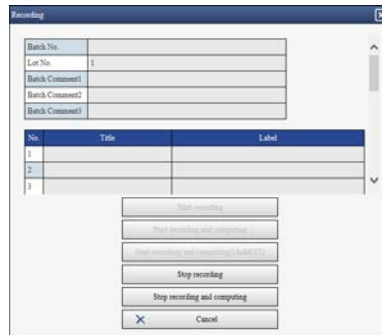

Starting, Stopping, Resetting, and Acknowledging Computing

Procedure

- 1 On the **SMARTDAC+ Web Service** tab, click **Computing**.
The Computing dialog box appears.
- 2 Click a button.
 - Start computing: Starts computing on math channels. The indicator below the **Computing** button turns on in blue.
 - Stop computing: Stops computing on math channels. The indicator below the **Computing** button turns off.
 - Start computing (MathRST): Resets computing on math channels and starts computing on math channels. The indicator below the **Computing** button turns on in blue.
 - Reset computing: Resets computing on math channels
 - Math ACK: Clears the icon that appears (on the GM) when a computation data dropout occurs.

Starting and Stopping Recording and Computing Using the GM10 START and STOP Keys

Starting Recording and Computing

Procedure

- 1 Hold down the GM10 **START** key for at least 3 seconds.
Recording starts, and the GM10's REC LED illuminates.
On models with computation (/MT option), depending on the start key setting, computing also starts when recording starts. The MATH LED illuminates.
To only start computing, press START, rather than holding it down.

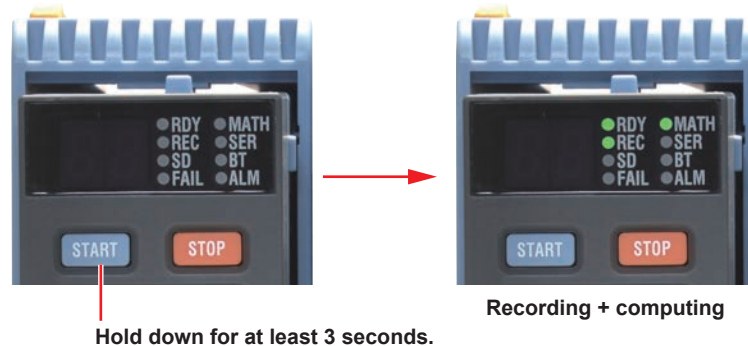

Stopping Recording and Computation

Procedure

- 1 Hold down the GM10 **STOP** key for at least 3 seconds.
Recording stops, and the GM10's REC LED turns off.
On models with computation (/MT option), depending on the stop key setting, computing also stops when recording stops. The MATH LED turns off.
To only stop computing, press STOP, rather than holding it down, when recording is stopped.

Explanation

Operations That Start When Recording Starts

- Reporting (/MT option)
- Computation (/MT option); when **START/STOP key action** is set to **Start / Stop or Reset + Start / Stop**)
- Predictive detection section (when the trigger type of section setting for prediction is set to **Sync with recording**)

Operations That Stop When Recording Stops

- Reporting (/MT option)
- Computation (/MT option): When stop key action is set to Stop
- Predictive detection section

Performance While Data Is Being Saved

If the internal memory or external storage medium is continuously accessed, the following phenomena may occur.

- Files being saved to the external storage medium drop out.
 - Accessing the GM through communication takes a long time.
- If these conditions occur, take the following measures.
- If you are creating data files at short intervals consecutively using the event action function, increase the data file save interval.
 - If you are creating numerous files in a single directory on the external storage medium, change the destination directory name at approximately every 1000 files.
 - If data recording and display are using up resources (for example if you are recording on multiple channels at a fast rate), reduce the recording interval, or change the display.

Alarm ACK

Follow the procedure below to acknowledge all alarms that are occurring.

Procedure

- 1** On the **SMARTDAC+ Web Service** tab, click **Alarm**.
The Alarm dialog box appears.
- 2** Click **Alarm ACK**.
Alarms are acknowledged.

Indicator below the Alarm button

See "Status Indications."

Setting the Date and Time

- ▶ For details on the settings, see page 2-23 in section 2.2, "Setting the Date and Time".

Starting, Stopping, and Testing Mail Transmission

Procedure

- 1** On the **Operation** tab, click **E-Mail function**.
The Mail function dialog box appears.
- 2** Click a button.
Start E-mail transmission: Enables the mail transmission function.
Stop E-mail transmission: Disables the mail transmission function.
E-Mail test for recipient 1 or E-Mail test for recipient 2: Sends a test mail to the recipient.

Triggering the Starting of Event Data Recording

Follow the procedure below to apply a start trigger for event data recording.

Procedure

- 1 On the **Operation** tab, click **Event trigger**.
The Event trigger dialog box appears.
- 2 Click **Execute event trigger**.
Event data recording that is in the trigger-wait state starts.

When the measurement mode is set to Dual interval, click **Execute Event trigger meas group 1**, **Execute Event trigger meas group 2**, or **Execute All**.

Executing Manual Sampling

Follow the procedure below to execute manual sampling.

Procedure

- 1 On the **Operation** tab, click **Manual sample**.
A Manual sample dialog box appears.
- 2 On the Operation tab, click **Execute a manual sample**.
Manual sampling is executed.

Saving Event Data

Follow the procedure below to save the event data being recorded to a file.

Procedure

- 1 On the **Operation** tab, click **Event save**.
An Event save dialog box appears.
- 2 Click **Save event data**.
The event data is saved.

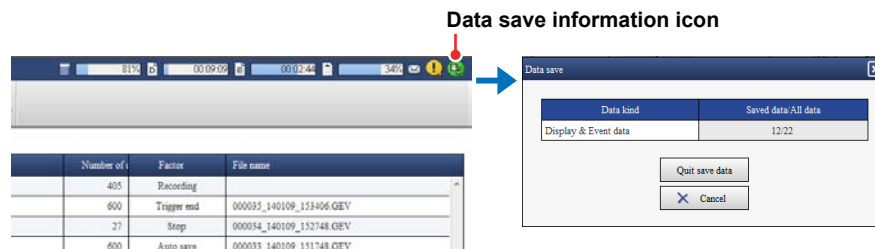

Saving Display Data

Follow the procedure below to save the display data being recorded to a file.

Procedure

- 1 On the **Operation** tab, click **Display save**.
A Display save dialog box appears.
- 2 Click **Save display data**.
The display data is saved.

Resetting a Relative Timer

Follow the procedure below to reset and start a relative timer.

Procedure

- 1** On the **Operation** tab, click **Timer reset**.
The Timer reset dialog box appears.
- 2** Select the timer check box you want to reset, and click **Reset**.
The timer is reset.

Resetting a Match Time Timer

Follow the procedure below to reset a timer that has expired.

Procedure

- 1.** On the **Operation** tab, click **Reset Match Time Timer**.
The Match time timer reset dialog box appears.
- 2.** Select the match time timer check box you want to reset, and click **Reset**.
The match time timer is reset.

Changing the batch number, lot number, and batch comment

Follow the procedure below to change the batch number, lot number, and batch comment. When the GM is recording, you can enter only batch comments that have not been entered yet.

Procedure

- 1** On the **Operation** tab, click **Batch**.
The Batch dialog box appears.
- 2** Enter the batch number, lot number, and batch comment, and click **Change**.
The batch number, lot number, and batch comment are changed.
For the procedure to enter the batch number, lot number, and batch comment, see page 2-122 in section 2.16, "Configuring the Batch Function".

Viewing the Batch text

Follow the procedure below to view the batch text set on the GM. You cannot change it.

Procedure

- 1** On the **Operation** tab, click **Batch**.
The Batch dialog box appears.
- 2** Check the batch text, and click **Cancel**.

Changing the Time Using SNTP

Follow the procedure below to query the SNTP server for the time and adjust the GM time.

Procedure

- 1** On the **Operation** tab, click **SNTP manual time adjustment**.
The SNTP manual time adjustment dialog box appears.
- 2** Click **Execute SNTP manual time adjustment**.
The GM queries the SNTP server for the time.

Performing a Test Print

Follow the procedure below to perform a test print.

Procedure

- 1 On the **Operation** tab, click **Test print**.
A Test print dialog box appears.
- 2 Click **Execute a test print**.
A test print is performed.

Executing a File Transmission Test on the FTP Server

Follow the procedure below to transfer a test file to the FTP server.

Procedure

- 1 On the **Operation** tab, click **FTP test**.
A FTP test dialog box appears.
- 2 Click **Execute an FTP test to the primary** or **Execute an FTP test to the secondary**.
The GM transfers a test file to the FTP server.

Items to Check before Performing This Test

- Connect the Ethernet cable correctly. ► For the connection procedure, see “Connecting to the Ethernet Port” in the First Step Guide.
- Check that the Ethernet interface settings are correct.
- For the setup procedure, see page 2-154 in section 2.22, “Configuring the Ethernet Communication Function”.

Checking the Results of the FTP Test

- When an FTP test is executed, a test file named FTP_TEST.TXT is transferred to the specified FTP destination directory.
- You can also check the result of an FTP test using the FTP log (► see “Error Log Monitor” on page 3-27) and Flog command (see the setting commands in the communication manual).

Clearing Error Displays

Follow the procedure below to clear an error display from the GM10's 7 segment LED.

Procedure

- 1 On the **Operation** tab, click **Clear Error Display**.
A Clear Error Display dialog box appears.
- 2 Click **Clear error display**.
The error display is cleared.

Clearing the Bluetooth Connection List (Bluetooth function (/C8 option))

Follow the procedure below to clear the Bluetooth connection list (pairing information cannot be deleted).

If a Bluetooth connection password is set, you will need to enter a password the next time you connect.

Procedure

- 1 On the **Operation** tab, click **Clear Bluetooth connection list**.
A Clear Bluetooth connection list dialog box appears.
- 2 Click **Clear Bluetooth connection list**.
The connection list is cleared.

Saving of health monitor log (Release number 5 and later)

Manually save the health monitor log to an external storage medium.

Procedure

- 1 On the **Operation** tab, click **Health Monitor Save**.
A Health monitor save dialog box appears.
- 2 Click **Save to SD card**.
The health monitor log is saved to an external storage medium.

Control of predictive detection section (Release number 5 and later)

Manually control the start, stop, and pause of the predictive detection section.

Note

- The predictive section can be controlled when recording is started.
- You must load profile trends and predictive detection models in advance. If both functions are enabled, both files must be loaded or the predictive detection section cannot be started.

Procedure

- 1 On the **Operation** tab, click **Predictive detection section**.
A Predictive detection section dialog box appears.

Button	Description
Start	Start the early warning detection interval. Enabled when the early warning detection interval is stopped.
Stop	Stop the early warning detection interval. Enabled when the early warning detection interval is started or paused.
Profile Pause	Press this key to pause the profile waveform.
Profile Resume	Press this key to resume a paused profile waveform.
Cancel	Closes the dialog box without performing any action.

3.1.2 Monitoring the GM Data and Controlling the GM from the Monitor Screen

You can retrieve data and display conditions from the GM and view the information using the monitors listed below. You can also perform alarm acknowledge and other operations.

Monitors Trend, digital, bar graph, horizontal bar graph, overview, alarm summary, message summary, DO channel status, internal switch status, Modbus master status, Modbus client status, WT client status, SLMP client status, memory data list, report data list, manual sampled data list, various error logs, network information, system information

On the trend monitor, digital monitor, bar graph monitor, and horizontal bar graph monitor, channel data is displayed in groups. Up to 4 groups can be displayed.

Display Update Interval

The channel data display is updated at the scan interval. However, the shortest update interval is 1 second.

Order of Display Precedence

If the display of the same type of items overlaps, the information of the smallest number takes precedence.
For example, if multiple alarms are occurring, the alarm with the smallest alarm level number takes precedence.

Note

- If the GM system configuration or settings change while the monitor is displayed, the monitor may not display data correctly.
In such a case, reload the page.

Switching the Monitor Display

Procedure

On the **Data** tab, click the monitor you want to display. **Favorite monitors** appears when you register a favorite monitor.

You can also switch the screen by clicking a monitor display switch button.

Data tab tree

Switch the monitor display

Change the channel display format

Pause and resume data updating

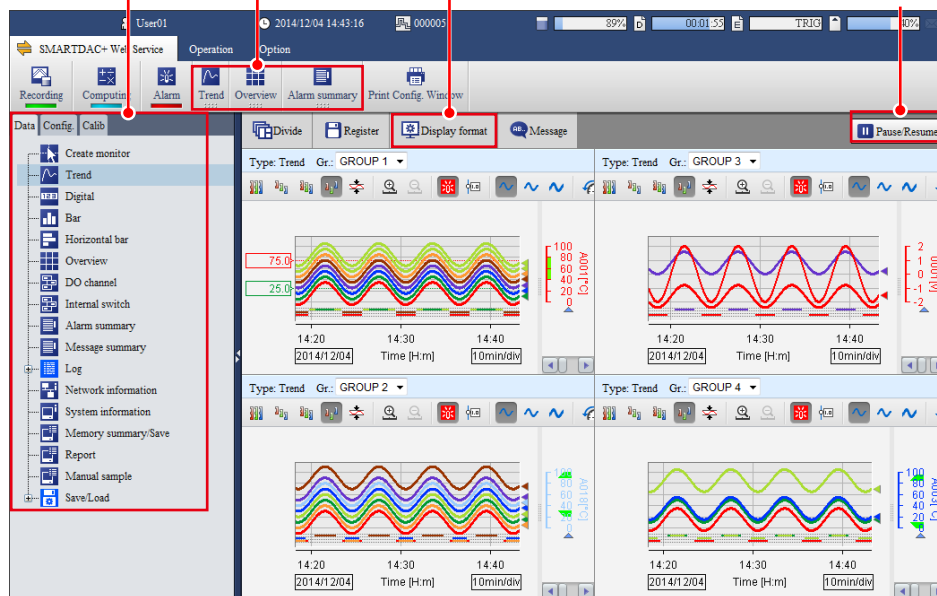

Note

You can change the monitor display switch buttons that are displayed on the menu bar. For the procedure, see "Changing the Channel Display Format" on page 3-10.

Pausing and Resuming Data Updating

Follow the procedure below to pause and resume monitor data updating.

Procedure

Each time you click **Pause/Resume**, the monitor data updating pauses or resumes. When data updating is paused, a section of the **Pause/Resume** button icon blinks.

Note

If the GM settings are changed when updating is paused, the paused state may be cleared.

Changing the Channel Display Format

Follow the procedure below to set the display format of channel names and the digital I/O channel values on the monitors. The settings are applied to all monitors.

Procedure

- 1 Click **Display format**.
A bar appears where you can specify the channel display.
- 2 Select the display format.



Item	Description
Channel	Set the display format of channel names to Channel No., Tag, or Tag No.
Digital label	Select the value display format of digital input channels and digital output channels.
Digit	Displays 0s and 1s as they are (using numbers).
Character	Displays 0s and 1s using predefined character strings, such as "OPEN" and "CLOSE." If character strings are not specified, they will be blank.

Favorite Monitors

Follow the procedure below to create favorite monitors. You can create up to 15 monitors.

Procedure

Registration

- 1 On the **Data** tab, click **Create monitor**.
A screen for creating a new monitor appears.

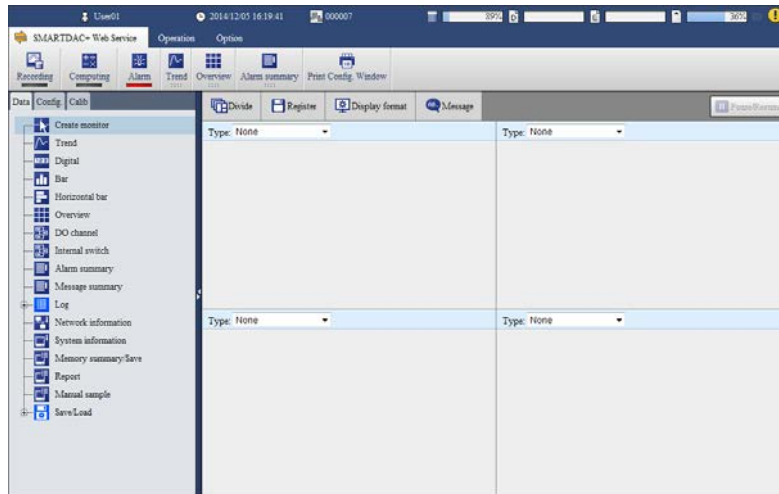

- 2 Click **Divide**.
Screen multi panel options appear.
- 3 Click the multi panel pattern to use.



- 4 From the **Type** list, select the screen type to display. You can also select None (to not register a screen).
- 5 If you select Trend, Digital, Bar, or Horizontal bar, select the display group from the **Gr.** list.
- 6 Repeat steps 4 and 5 to assign screens to all areas.
- 7 Click **Register**.
The Name box appears.
- 8 Enter the monitor name, and click **Register**.
The monitor name is added under **Favorite monitors** in the content selection tree.



Monitor name

- You can enter up to 16 characters.
- Tabs will be replaced with spaces.
- Hats (^), single quotation marks, and semicolons will be replaced with underscores.
- Preceding and trailing spaces will be deleted.

Deleting a Favorite Monitor

- 1 In the content selection tree, point to the favorite monitor you want to delete.
- 2 Click the X mark that appears to the right of the monitor name.
A confirmation dialog box appears.

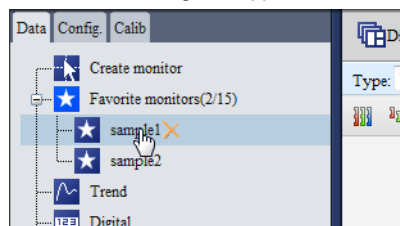

- 3 Click **OK**.
The monitor name is deleted from the content selection tree.

Note

You cannot edit a favorite monitor that you created before. If you want to change a favorite monitor, create a new monitor, and overwrite the old one by specifying the same name.

Trend Monitor, Digital Monitor, Bar Graph Monitor, and Horizontal Bar Graph Monitor

Trend Monitor

Trend displays are shown by group.

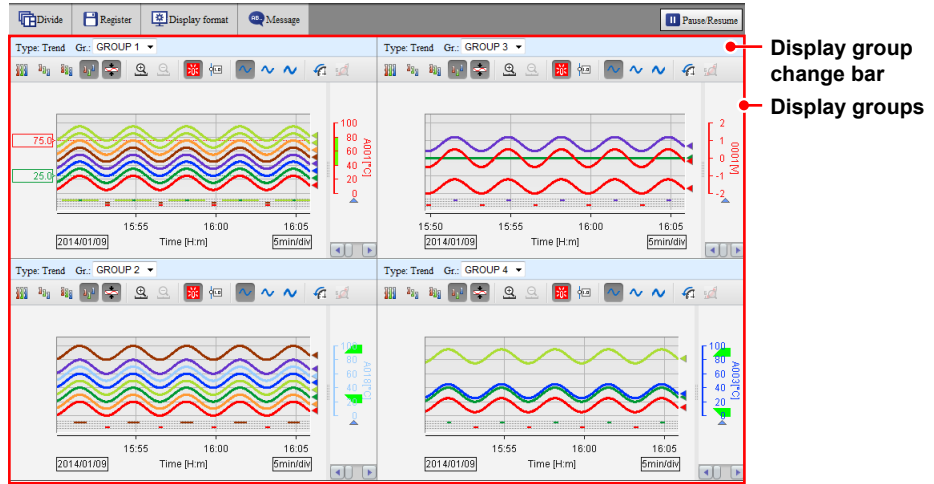

Digital Monitor

Digital displays are shown by group.

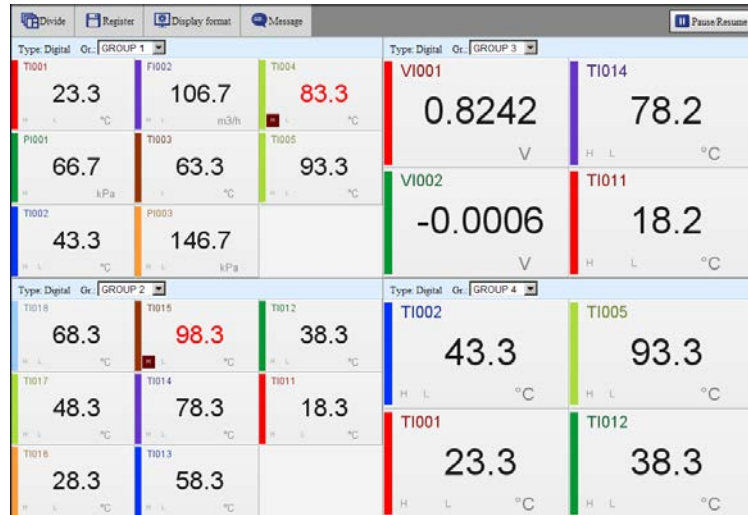

Bar Graph Monitor and Horizontal Bar Graph Monitor

Bar graph displays or horizontal bar graph displays are shown by group.

Bar Graph Monitor



Horizontal Bar Graph Monitor

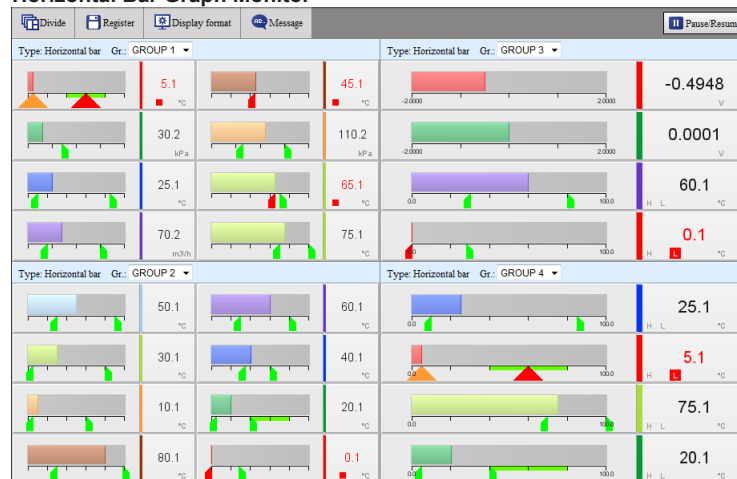

Note

- When you start the Web application for the first time, display groups are displayed in accordance with the default conditions. Change the display groups if necessary.
- Changes that you make to the monitor are always retained.

Changing the Division Setting of the Screen (Trend, digital, bar graph and horizontal bar graph monitors)

Follow the procedure below to change the division setting of the screen. If you change the division setting, check the group displayed in each area, and change it if necessary (see "Changing Display Groups"). The division setting applies to all four monitors.

Procedure

- 1 Click **Divide**.
A bar appears where you can select the division setting.
- 2 Click the appropriate setting.
The screen is divided accordingly.

Changing Display Groups (Trend, digital, bar graph and horizontal bar graph monitors)

Follow the procedure below to change the group to show in each area. This setting applies to all four monitors.

Procedure

On the display group change bar, select the display group from the **Gr** list.

Note

You can change an existing monitor and register it as a favorite monitor. For the registration procedure, see "Favorite Monitor" on page 3-14.

Writing Messages

Follow the procedure below to write a message at the current time position in the data being recorded. You can execute this procedure when a trend, digital, bar graph, horizontal bar graph, overview, alarm summary, message summary, log, DO channel status, or internal switch status is displayed. When you write a message, the screen temporarily shows an alternate screen (see note on page 3-6). The message is displayed on the trend. You can also view it in the message summary.

Procedure

- 1 Click **Message**.
A bar appears where you can set the message to write.
- 2 Select **Preset** or **Free** to specify the message.
Preset messages are fixed messages set in the GM. Select a message from the list. Free messages are messages that you enter on the spot. Select a message number from the list, and enter the message string in the text box.



Free messages

- Up to 32 characters
- Single quotation marks and semicolons will be replaced with spaces.

- 3 From the **Write to** list, select the display group to write to. Select **All groups** to write the message to all groups.
- 4 Click **Write**.
The message is written. See the screen example on the next page.

Note

If you write a free message, the message string set in the GM will also be replaced.

Trend

The description of a trend screen that can be displayed in one of the divided areas is given below.

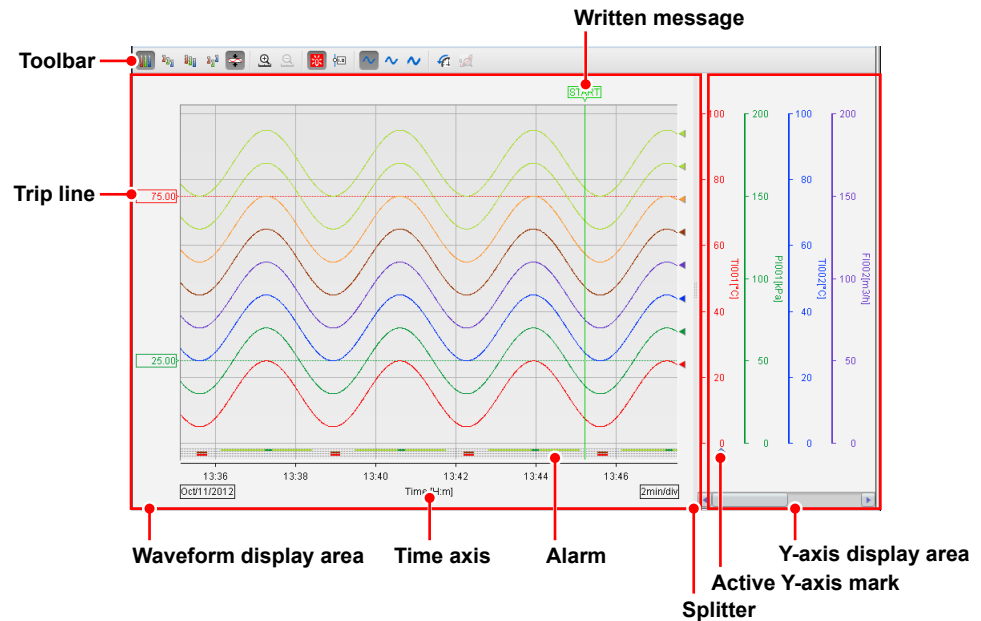

Name	Description
Toolbar	Change the trend waveform display mode.
Waveform display area	Displays channel data as waveforms.
Y-axis display area	Displays the Y-axis of each channel. Each Y-axis displays a scale image, channel name, and unit. Alarm point marks and color scale bands are also displayed.
Splitter	Drag the splitter to adjust the sizes of the waveform display area and Y-axis display area.

Note

- The time axis displays the time of day. It does not display the elapsed time from the start of recording.
- Partial expanded display is not possible.
- If a change is made on the GM that disrupts the continuity of the data, the trend will be cleared.

Changing the Trend's Active Y-Axis

This procedure applies to the trend display.

What Is the Active Y-axis?

The active Y-axis refers to the Y-axis that has focus among the multiple waveforms. The waveform display area shows horizontal grid lines that correspond to the active Y-axis.* The corresponding waveform is also shown in front.

- * If auto zone or free zone is in use (see the next page), the horizontal grid lines of the Y-axes that are in the same column as the active Y-axis are also shown.

Procedure

In the Y-axis area, click a Y-axis to activate it. The active waveform icon appears below the new active Y-axis.

Changing the Trend's Waveform Display

This procedure applies to the trend display. You can click the icons in the figure below to change the waveform display.

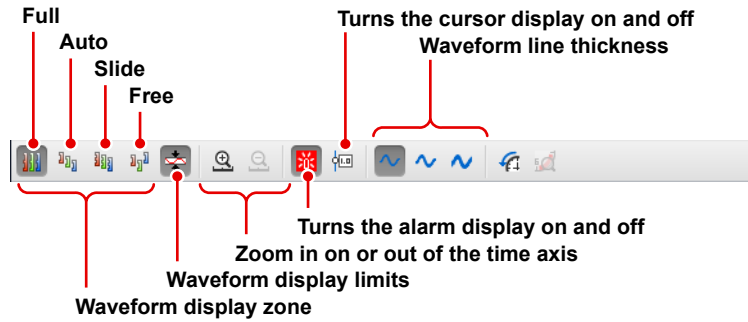

Waveform Display Zone

Change the waveform display zone.

Name	Description
Full	Displays all waveforms in full zones.
Auto	Divides the waveform display area into equally spaced zones in accordance with the number of displayed waveforms and displays the waveforms.
Slide	Displays each waveform cascaded from the top to the bottom of the waveform display area.
Free	Displays waveforms in zones specified on the GM.

The following figure shows the Y-axes of each display zone.

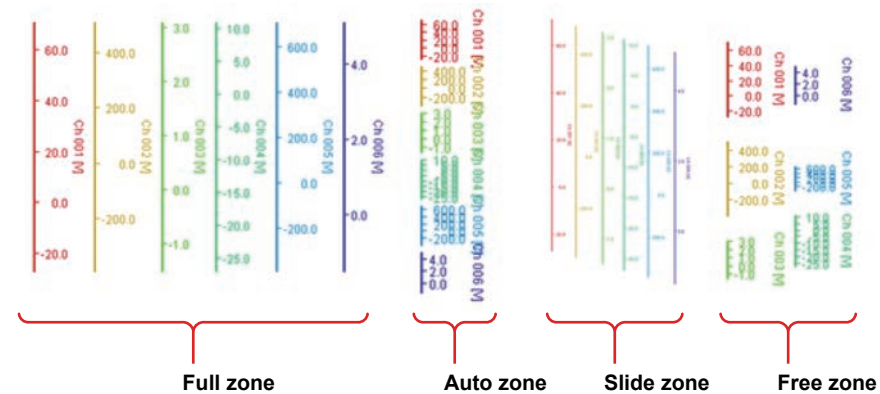

Waveform Display Limits

If you apply the waveform display limit, the Y-axis display range is limited to the minimum and maximum values of the scale. Values that are less than the minimum scale value are set to the minimum value, and values that are greater than the maximum scale value are set to the maximum value.

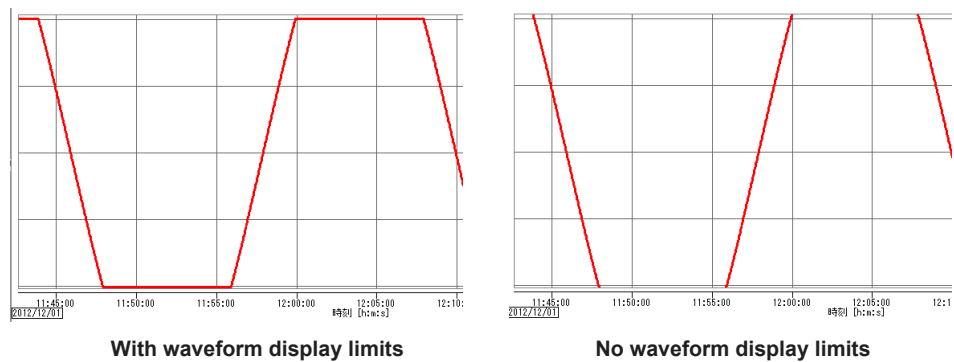

Zooming In on or Out of the Time Axis

You can zoom in on or out of the time axis.

Alarm Display

Alarm information is displayed in the bottom area. Alarm levels (1, 2, 3, and 4) are displayed in order from the top. The duration of each alarm is indicated with a bar using the same color as the corresponding channel. Alarms of channels that correspond to the active Y-axis are shown in front.

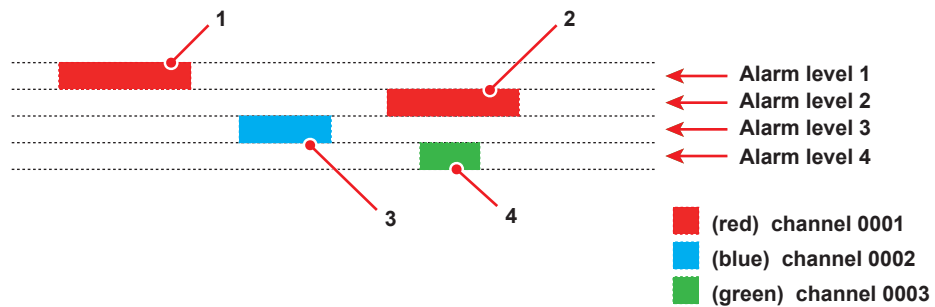

Number	Description
1	An alarm level 1 alarm on channel 0001
2	An alarm level 2 alarm on channel 0001
3	An alarm level 3 alarm on channel 0002
4	An alarm level 4 alarm on channel 0003

Cursor

You can use cursors to read the values at the cursor. Click the cursor display icon, and click a location on the waveform display area. A cursor appears, and the channel values at the cursor position is displayed in pop-up windows. Drag the pointer to display two cursors. You can read the values at the two positions.

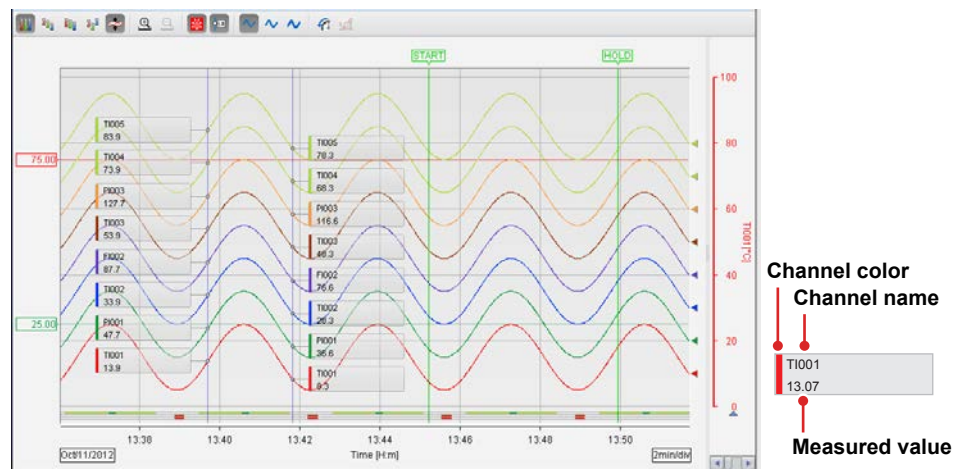

Note

- The pop-up window for the waveform that corresponds to the active Y-axis is shown in front.
- When waveform display limit is enabled, “+Over,” “-Over,” and “BURNOUT” are displayed for channel values when appropriate.

Waveform Line Thickness

You can change the waveform line thickness.

Trip Lines

Trip lines are displayed for the active Y-axis and the Y-axes displayed in the same column as the active Y-axis.

Displaying Trends' Past Data

You can display past data as a trend. This is called historical trend.

Data and Interval That Can Be Displayed as a Historical Trend

The current recording and past recording data can be displayed as historical trends over the following interval.

Interval: From the point when 1 points of data is recorded since the start of recording until the start of the next recording.

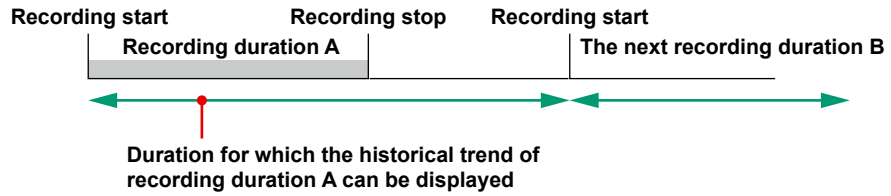

Displaying the Historical Trend

Click the historical trend icon to display the historical trend. You can use the scroll bar to adjust the display range.

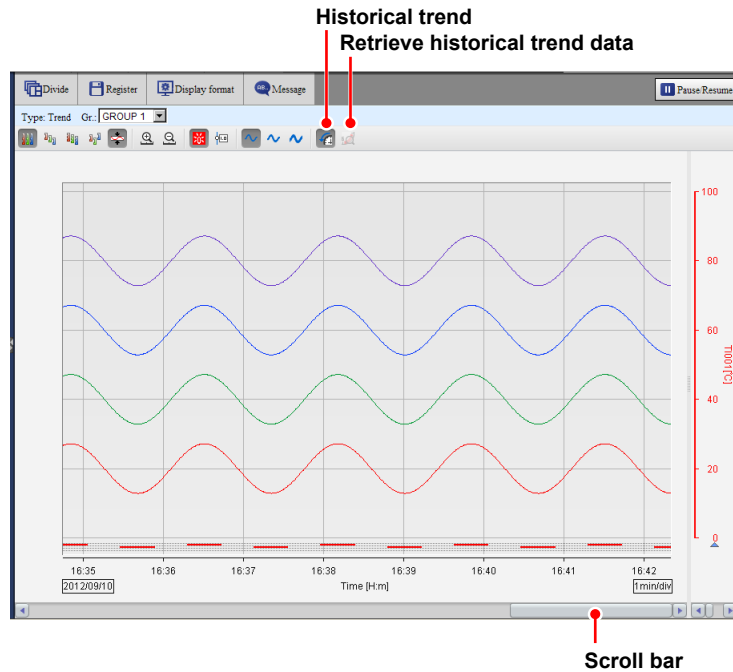

You can carry out the following operations. The procedures are the same as those for the trend display.

- Change the active waveform
- Change the waveform display zone and waveform display limits
- Zoom in on or out of the time axis
- Show or hide alarms information
- Show or hide cursors

The cursor value for display data shows the minimum and maximum values.



- Change the waveform line thickness

Retrieving Historical Trend Data

Follow the procedure below to retrieve historical trend data from the GM.

Note

The Web application has a buffer for historical trend data. The buffer can hold 3600 data points per channel. By retrieving the historical trend data, you can view the data that has been loaded into this buffer from the GM.

- 1 Click the retrieve historical trend data icon.
A dialog box appears where you can specify the range of historical trend data to retrieve.
- 2 Drag the scroll bar and selection window to specify the interval of historical trend data to retrieve.

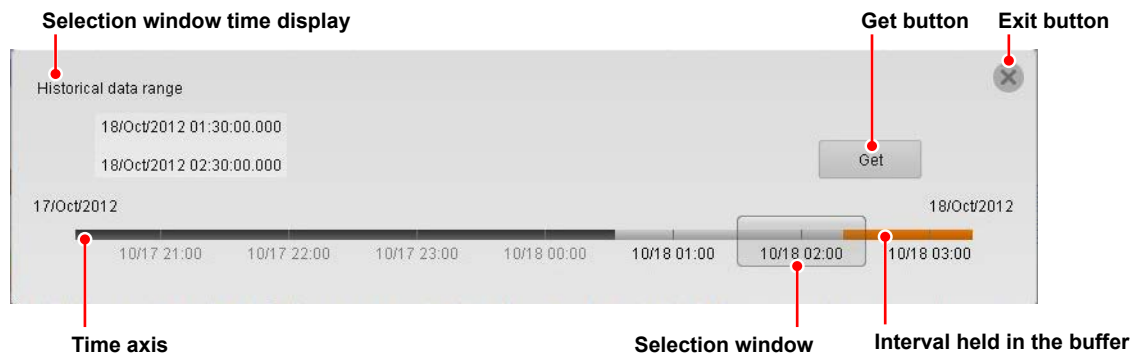

- 3 Click **Retrieve**.
Data retrieval starts. When the data retrieval is complete, the historical trend data is displayed.

Note

If the clock was changed (excluding gradual time adjustment) or a power failure occurred during recording, for data before the last time disruption, the time between what is selected in the dialog box for specifying the interval of historical trend data to retrieve and the actual data will be misaligned. Displaying such data is possible.

Digital

The description of a digital screen that can be displayed in one of the divided areas is given below.



Alarm Marks

Alarm Status	Alarm ACK	Background Color
On	Unacknowledged alarms present.	Alternating bright and dark red
On	All alarms acknowledged.	Bright red
Off	Unacknowledged alarms present.	Blinking gray
Off	All alarms acknowledged.	No change

When Information Cannot Be Read

Due to space limitations, channel information may not be displayed. If you place the pointer in a channel area and leave it there for about 1 second, the channel name, digital value, and unit will appear in a pop-up window.

Executing Individual Alarm Acknowledges, Changing Alarm Values, and Changing DO Output (DO set to Manual), Changing AO Output

Click a channel area to display a channel information dialog box of that channel.



- **Executing an Individual Alarm ACK (AI channel)**

Click **ACK**.

The individual alarm is acknowledged.

* If the alarm type is profile high limit or profile low limit, the alarm value is not displayed.

- **Changing the Alarm Value (AI channel)**

Enter a value in the alarm value text box, and click **Send**.

The alarm value will be changed.

* If the alarm type is profile high limit or profile low limit, the alarm value is not displayed.

- **Changing the DO Output (DO channel set to Manual)**

You can control the DO output from the channel information dialog box.

- **Changing AO Output (AO channel)**

You can control the AO output from the channel information dialog box.

▶ See “Individual AO Channel Operation from the Monitor” on page 3-32.

If the operation fails, a message appears in the bottom line of the channel information dialog box.

Bar Graph Monitor and Horizontal Bar Graph Monitor

The description of the bar graph or horizontal bar graph that can be displayed in one of the divided areas is given below.

Bar Graph

The bar graph is shown vertically, and the starting point of bars is as according to the GM setting.

Horizontal Bar Graph

The bar graph is shown horizontally, and the starting point of bars is as according to the GM setting.

Bar Graph

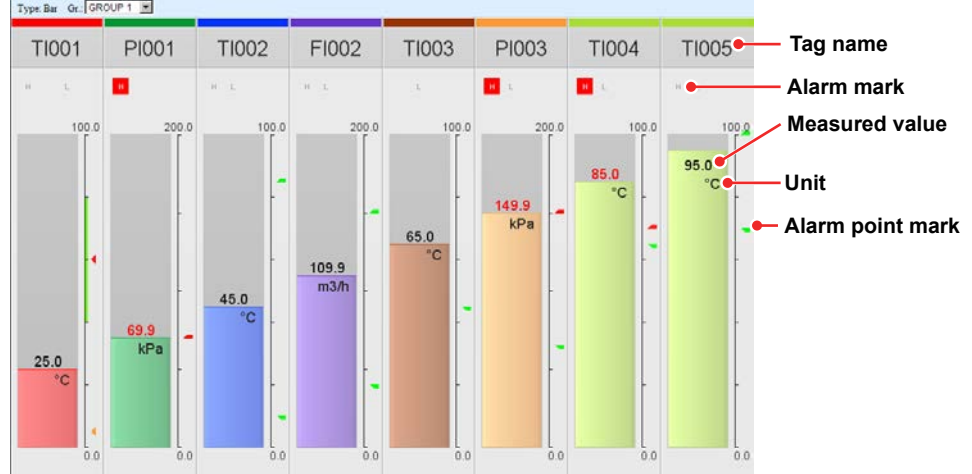

Horizontal Bar Graph



Alarm Marks

See "Digital."

When Information Cannot Be Read

Due to space limitations, channel information may not be displayed. If you place the pointer in a channel area and leave it there for about 1 second, the channel name, digital value, and unit will appear in a pop-up window.

Executing Individual Alarm Acknowledges, Changing Alarm Values, and Changing DO Output (DO set to Manual)

See "Digital" on 3-21.

Overview Monitor

The following four types of overview monitors are available.

- All channel
- Display group
- Display group (detail display)
- Channel in display group

All channel overview

Display group overview

Display group overview (detail display)

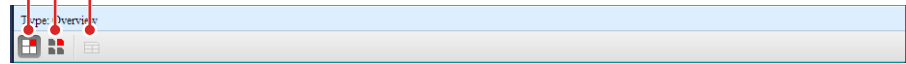

Channel-in-display-group overview can be displayed from the display group overview.

All channel

The all channel overview can be displayed when the number of active channels is 100 or less. The screen shows channel names, digital values, units, alarm statuses, and types of active alarms.

Type: Overview					
V001	0.9990	V	Off	F001 H	70.0 kPa
	Start		Off	T003	45.0 °C
	Start		Off	F002	110.0 mA
	Start		On	T003	65.0 °C
	Start		On	F003 H	150.0 kPa
	Start		On	T004 H	85.0 °C
	Start		On	T005	95.0 °C
	Off		On	T011	20.0 °C
	Off		On	T012 H	40.0 °C
	Off	T001	25.0 °C	T013 H	60.0 °C
				T014 H	80.0 °C
				T015 H	100.0 °C
				T016	30.0 °C
				T017	50.0 °C
				T018	70.0 °C

Display Item	Description																					
Channel name	Displays the channel number, tag, or tag number. If the information does not fit, the portion that does not fit is displayed with an ellipsis (...).																					
Digital value	If the value does not fit, it is not displayed.																					
Unit	If the value does not fit, it is not displayed.																					
Type of active alarm	Of the active alarms, the alarm type of the lowest alarm level is displayed.																					
Alarm status	The alarm status at the channel level is displayed with a background color. When the alarm display is set to Nonhold <table border="1"> <thead> <tr> <th>Alarm Status</th> <th>Background Color</th> </tr> </thead> <tbody> <tr> <td>On</td> <td>Red</td> </tr> <tr> <td>Off</td> <td>Green</td> </tr> </tbody> </table> When the alarm display is set to Hold <table border="1"> <thead> <tr> <th>Alarm Status</th> <th>Alarm ACK</th> <th>Background Color</th> </tr> </thead> <tbody> <tr> <td>On</td> <td>Unacknowledged alarms present.</td> <td>Alternating bright and dark red</td> </tr> <tr> <td>On</td> <td>All alarms acknowledged.</td> <td>Bright red</td> </tr> <tr> <td>Off</td> <td>Unacknowledged alarms present.</td> <td>Alternating green and white</td> </tr> <tr> <td>Off</td> <td>All alarms acknowledged.</td> <td>Green</td> </tr> </tbody> </table>	Alarm Status	Background Color	On	Red	Off	Green	Alarm Status	Alarm ACK	Background Color	On	Unacknowledged alarms present.	Alternating bright and dark red	On	All alarms acknowledged.	Bright red	Off	Unacknowledged alarms present.	Alternating green and white	Off	All alarms acknowledged.	Green
Alarm Status	Background Color																					
On	Red																					
Off	Green																					
Alarm Status	Alarm ACK	Background Color																				
On	Unacknowledged alarms present.	Alternating bright and dark red																				
On	All alarms acknowledged.	Bright red																				
Off	Unacknowledged alarms present.	Alternating green and white																				
Off	All alarms acknowledged.	Green																				

Due to space limitations, channel information may not be displayed. If you place the pointer in a channel cell and leave it there for about 1 second, the channel name, digital value, unit, and the type of active alarm will appear in a pop-up window.

- **Executing Individual Alarm Acknowledges, Changing Alarm Values, and Changing DO Output (DO set to Manual)**

See “Digital” on 3-23.

Display group

The display group overview shows groups.

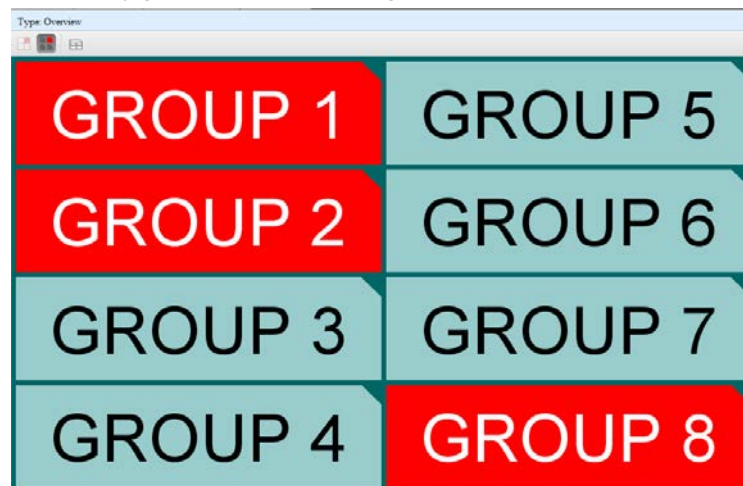

Display Item	Description
Display group name	If the information does not fit, the portion that does not fit is displayed with an ellipsis (...).
Alarm status	The alarm status at the group level is displayed with a background color. For details on the background color, see “Alarm status” in “All Channel.”

Due to space limitations, channel information may not be displayed. If you place the pointer in a group area and leave it there for about 1 second, the group name will appear in a pop-up window.

Display group (detail display)

When the display group overview is shown, you can click the detail display button to enable and disable detail display mode. Channels in each group are displayed.

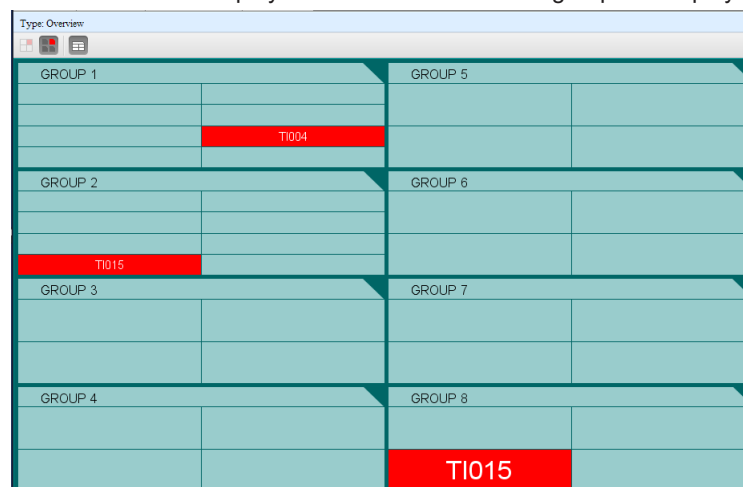

Display Item	Description
Display group name	If the information does not fit, the portion that does not fit is displayed with an ellipsis (...).
Channel name	A channel name is displayed in the appropriate cell if the channel has an active alarm or has an unacknowledged alarm when the alarm is set to Hold . If the information does not fit, the portion that does not fit is displayed with an ellipsis (...).
Alarm status	The alarm status at the channel level is displayed with a background color. For details on the background color, see “Alarm status” in “All Channel.”

Due to space limitations, channel information may not be displayed. If you place the pointer in a group name area and leave it there for about 1 second, the group name will appear in a pop-up window. If you place the pointer in a channel area and leave it there for about 1 second, the channel name will appear in a pop-up window.

Channel in display group

When the display group overview is shown, you can click one of the display group areas to display an overview of that group. The displayed information is the same as with “All channel.”

Return to the display group overview.

Switch the display group.

GROUP 1	
TI001 24.8 °C	TI003 64.8 °C
PI001 69.7 kPa	PI003 149.7 kPa
TI002 44.8 °C	TI004 H 84.8 °C
FI002 109.7 m3/h	TI005 94.8 °C

- **Executing Individual Alarm Acknowledges, Changing Alarm Values, and Changing DO Output (DO set to Manual)**
See “Digital” on 3-24.

Alarm Summary Monitor

The alarm summary monitor displays the GM alarm summary. Up to 1000 items can be displayed.

When the measurement mode is set to Dual interval, alarm ACK remains for each scan group.

Type	Channel No.	Level	Type	Time
ON	A014	1	H: High limit	2014:01:09 16:01:28.000
ON	A013	1	H: High limit	2014:01:09 16:01:28.000
ON	A012	1	H: High limit	2014:01:09 16:01:28.000
ON	A015	1	H: High limit	2014:01:09 16:01:10.500
ACK				2014:01:09 16:00:25.500
ON	A007	1	H: High limit	2014:01:09 16:00:24.500
OFF	A011	3	L: Low limit	2014:01:09 16:00:02.000
OFF	A007	2	L: Low limit	2014:01:09 16:00:02.000
OFF	A005	2	L: Low limit	2014:01:09 16:00:02.000
OFF	A001	3	L: Low limit	2014:01:09 16:00:02.000
ON	A011	3	L: Low limit	2014:01:09 15:59:48.000
ON	A007	2	L: Low limit	2014:01:09 15:59:48.000
ON	A005	2	L: Low limit	2014:01:09 15:59:48.000
ON	A001	3	L: Low limit	2014:01:09 15:59:48.000
OFF	A007	1	H: High limit	2014:01:09 15:59:20.000
OFF	A015	1	H: High limit	2014:01:09 15:58:34.500
OFF	A014	1	H: High limit	2014:01:09 15:58:21.500
OFF	A013	1	H: High limit	2014:01:09 15:58:21.500

Saving the Alarm Summary

Click **Alarm save**, and follow the instructions in the dialog box that appears. The alarm summary can be saved to an SD card or USB flash memory.

Sorting

Click a column title to sort the alarm summary in ascending or descending order of that column.

Rearranging Columns

You can rearrange columns by dragging the column title areas. However, the left most column is fixed.

Changing Column Widths

You can change the column widths by dragging the column boundaries.

Copying to the Clipboard

Drag the cursor to select the list. Press Ctrl+C on the keyboard to copy the selected list to the clipboard.

Message Summary Monitor

The message summary monitor displays the GM message summary. Up to 450 items can be displayed.

Message	Data Time	Group	User Name
HOLD	Oct 11 2012 13:48:57	ALL	
START	Oct 11 2012 13:45:14	ALL	
START	Oct 11 2012 13:23:33	ALL	
START	Oct 11 2012 10:46:36	ALL	

You can sort, rearrange columns, change column widths, and copy to clipboard.

Error Log Monitor

The error log monitor displays the GM error log. The following figure shows an error log display.

Time	NO	Message
2014-01-09 16:03:00	658	Could not connect to SMTP server.
2014-01-09 16:01:30	658	Could not connect to SMTP server.
2014-01-09 16:00:30	658	Could not connect to SMTP server.
2014-01-09 15:43:32	211	This function is not possible at this time.
2014-01-09 15:39:45	658	Could not connect to SMTP server.
2014-01-09 15:38:15	658	Could not connect to SMTP server.
2014-01-09 15:37:15	658	Could not connect to SMTP server.
2014-01-09 15:36:44	658	Could not connect to SMTP server.
2014-01-09 15:35:14	658	Could not connect to SMTP server.
2014-01-09 15:34:14	658	Could not connect to SMTP server.
2014-01-09 15:33:46	519	Template file not loaded.
2014-01-09 15:28:17	519	Template file not loaded.
2014-01-08 15:53:42	504	Media read error.
2014-01-08 15:53:42	504	Media read error.
2014-01-08 15:53:42	504	Media read error.
2014-01-08 15:53:42	504	Media read error.
2014-01-08 15:53:42	504	Media read error.
2014-01-08 15:53:42	504	Media read error.
2014-01-08 15:53:42	504	Media read error.

You can sort, rearrange columns, change column widths, and copy to clipboard. The maximum number of log entries is shown below.

Type	Maximum Number of Displayed Events
Event log	50 Without advanced security function (/ AS)
	3000 With advanced security function (/ AS)
Error log	50
FTP log	50
Web log	200
Mail log	50
SNTP log	200
Modbus log	200
DHCP log	200
General log	200
Health monitor log	300

Event log *

Action	Description
Login	Login
Logout	Logout
NewTime	Time change when recording is stopped
TimeChg	Time change through touch operation
PowerOff	Power off (including power failures)
PowerOn	Power on (including recoveries from power failures)
TRevStart	Start of gradually adjusting the time
TRevEnd	End of gradually adjusting the time
SNTPTimeset	Time change by SNTP
DSTStart	Start of Daylight Saving Time
DSTEnd	End of Daylight Saving Time

* If you are using the advanced security function (/AS option), see the Advanced Security Function User's Manual (IM 04L55B01-05EN).

Factor	Description
OPERATE	Key operation
COMMU	Operation via communication
REMOTE	Operation through the remote control function
ACTION	Operation through event action
SYSTEM	Operation by the system
SERIAL	Operation through serial communication

Error log

► For the error codes and error messages, see page 5-20 in section 5.2.1, "Messages".

General log

User ID Number	Description
e0	Command exchanged through Ethernet connection #0
e1	Command exchanged through Ethernet connection #1
e2	Command exchanged through Ethernet connection #2
e3	Command exchanged through Ethernet connection #3
s0	Command exchanged through serial communication
s1	Command exchanged through Bluetooth connection
s2	Command exchanged through USB Function

Input/Output Symbol	Description
>	Indicates a command that the GM received
<	Indicates a response that the GM sent

Message	Description
(Over length)	Appears when the length of a command received by the GM exceeded the limit
(Serial error)	Appears when a serial communication error occurred
(output)	Displays a response that was sent in response to an output command or setting query. This message appears in place of the response content.
(disconnected)	Appears when the GM disconnected communication due to a timeout or other reason.

FTP log

Flag	Description
P	File was sent to the primary FTP destination.
S	File was sent to the secondary FTP destination.

WEB log

Method, IP address	Description
GET	Displays the HTTP method in which an error occurred. The IP address of the external device in which the error occurred is also displayed.
POST	

Mail log





Type	Description
ALARM	Alarm mail transmission
TIMER	Scheduled mail transmission
POWER	Power-on, power failure recovery
MEMORY	Memory full notification
ERROR	Error message mail
REPORT	Report file transmission
TEST	Test mail transmission
PASSWORD	User lock out
HEALTH SCORE	Health score notification mail

SNTP log

Error Code	Description
ELINK	The Ethernet cable is not connected. Check the GM Ethernet cable connection.
EDORMANT	An internal processing error occurred. Contact your nearest YOKOGAWA dealer.
EHOSTNAME	The SNTP server host name is invalid. Check the GM Ethernet cable connection, IP address setting, and SNTP server address setting.
ETCPIP	An internal processing error occurred. Contact your nearest YOKOGAWA dealer.
ESEND	Failed to transmit data to the SNTP server. Check the GM Ethernet cable connection and IP address setting.
ERECV	Failed to receive data from the SNTP server. Check the GM Ethernet cable connection and IP address setting.
EBROKEN	The SNTP server returned an invalid response. The SNTP server may be in a condition that cannot deliver time information. Check the SNTP server status.
ETIMEDOUT	The response from the SNTP server timed out. Check the GM Ethernet cable connection.
EOVER	The time difference between the GM and SNTP server has exceeded the limit for correcting the time. Check whether the SNTP server is running properly and the limit for correcting the time.
EBUSY	Cannot execute because the time has already been changed.

Modbus log



Flag	Description
C	Communication by the Modbus client function (Ethernet)
M	Communication by the Modbus master function (serial)

Status	Factor	Description	
W		Write	
R		Read	
Blue 		Normal communication.	
Yellow 		An external Modbus device returned an error response.	
Orange 		TCP connection in progress.	
Red 		Failed to connect to an external Modbus device.	
Common to colors other than blue	SKIP	Command not set.	
	INVALID	Command cannot be executed.	
	WAITING	Communication with an external device is congested. Waiting for recovery. Check the connection with the external device.	
	CLOSED	Modbus communication was stopped, and connection to the external device was closed.	
	RESOLVING	Server/slave connection being established (resolving address).	
	CONNECTING	Server/slave connection being established (requesting connection).	
	UNREACH	The external device was not found on the network. Check the Modbus server address setting and Ethernet cable connection.	
	TIMEOUT	The response from the external device timed out. Check the connection with the external device.	
	BROKEN	A CRC error was detected in the serial communication with the external device. Check the serial communication baud rate and other settings.	
	ERR_FC	The external device returned an error response. Check whether the Modbus registers are set correctly to match the external device.	
	ERR_ADDR		
	ERR_VALUE		
	ERR_DEVICE		
	ERR_ACK		
	ERR_BUSY		
	ERR_NEGATIVE		
	ERR_GATE_PATH		Check whether the Modbus connection destination unit number is correct.
	ERR_GATE_TARGET		The external device returned an error response. Check whether the Modbus registers are set correctly to match the external device.
	BAD_SLAVE	The external device returned an invalid response. Check whether the external device is operating properly.	
	BAD_FC		
	BAD_ADDR		
	BAD_NUM		
	BAD_CNT		
	VALID	Modbus communication was established normally.	
	START	Modbus communication started.	
	STOP	Modbus communication stopped.	
	DROPOUT	Failed to send all commands within the specified communication interval. Check the number of Modbus commands and the baud rate.	
	NO_DATA	Data has not yet been received once. Check the communication settings.	

DHCP log

Type	Message	Description
LINK	ON	Ethernet cable connection was detected.
	OFF	Ethernet cable disconnection was detected.
SET	Address (e.g., 10.0.122.3)	The IP address of the GM was set.
DHCP	OFF	The DHCP function was disabled.
	ON	The DHCP function was enabled.
	RENEWING	The IP address obtained from the DHCP server was renewed.
	RELEASING	The IP address obtained from the DHCP server was released.
	REJECTING	The IP address obtained from the DHCP server was rejected. Check whether the DHCP server is operating properly. 1
	RENEWED	IP address was renewed.
	RELEASED	IP address was released.
	EXTENDED	IP address extension application complete.
	ESEND	DHCP message transmission failed. Check the Ethernet cable connection.
	ESERVER	DHCP server search failed. Check whether the DHCP server is available.
	ESERVFAIL	The response from the DHCP server timed out. Check the Ethernet cable connection. Check whether the DHCP server is operating properly.
	ERENEWED	IP address renewal failed. Check the Ethernet cable connection. Check whether the DHCP server is operating properly.
	ERELEASED	IP address release failed. Check the Ethernet cable connection.
	EEXTENDED	IP address extension application failed. Check the Ethernet cable connection. Check whether the DHCP server is operating properly.
	EEXPIRED	IP address lease period expired. IP address was reset to 0.0.0.0. Check the Ethernet cable connection. Check whether the DHCP server is operating properly.
	DNS	UPDATED
REMOVED		DNS host name removal complete.
EFORMERR		DNS message syntax error was found. Check whether the DNS server is operating properly.
ESERVFAIL		An internal processing error occurred in the DNS server. Check whether the DNS server is operating properly.
EINTERNAL		
ENONAME		
ENXDOMAIN		Query to the DNS server wave rejected. Check whether the GM domain name setting is correct.
EREFUSED		
EYXDOMAIN		The GM does not support DNS servers that require host name registration authentication. Check whether the DNS server supports host name registration without authentication.
EYXRESET		
ENXRESET		
ENOTAUTH		
ENOTZONE		

Health monitor log

Item	Description
Start time	Displays the date and time when the early warning detection was started.
Stop time	Displays the date and time when stop time warning detection was stopped.
Predictive model	Displays the name of the predictive detection model.
Health score	Displays the health score.
Result	 : OK  : NG (Not Good)

Changing the Status Display and Output of DO Channels

You can display the DO channel status of the entire system. You can change the DO output that are set to Manual.

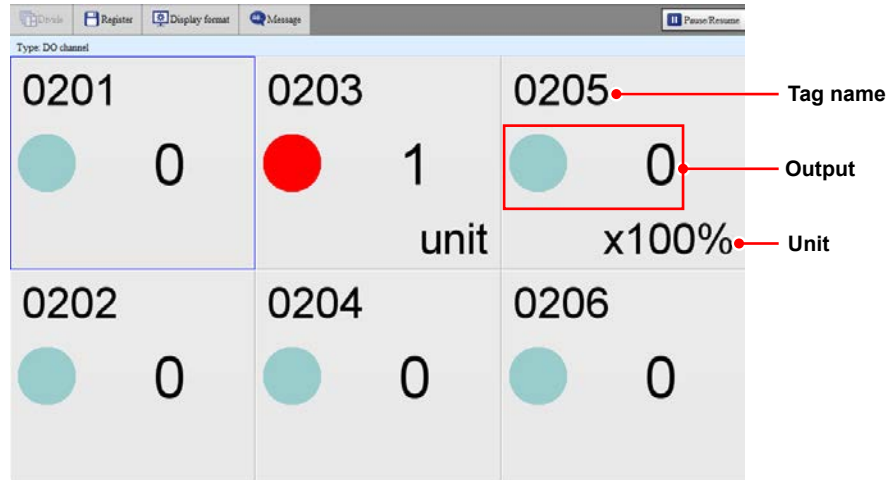

- Up to 60 channels can be displayed. When the display area of each channel becomes small, some of the information will not be displayed.
- The display is updated every second.

Changing the DO Output (DO channel set to Manual)

Click a channel area to display a channel information dialog box of that channel. You can control the DO output from the channel information dialog box.

Individual AO Channel Operation from the Monitor

From the monitor, you can individually operate the AO channel assigned to retransmission output or manual output.

Retransmission output: Turn on and off the retransmission output.

Manual output: Set the output value.

You can carry out this procedure on the digital, bar graph, horizontal bar graph, and overview displays.

In **Display settings**, under **Screen display settings**, Changing each value from monitoring **On/Off** must be set to **On**.

Users whose Output operation under User property in the security settings is set to LOCK cannot turn retransmission output on or off or operate the manual output.

Retransmission output on/off

- 1 Select an AO channel.
The channel information screen appears.

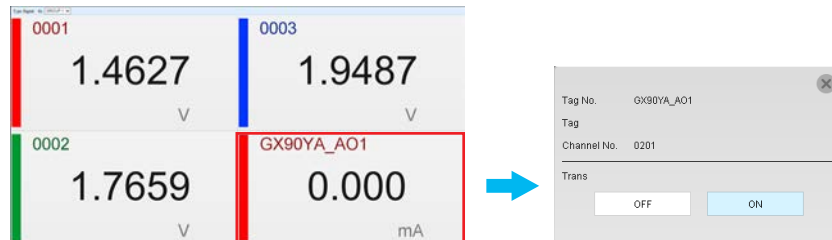

The highlighted one is the current state.

- 2 Select **ON** or **OFF**.
The selected value (ON or OFF) takes effect.

Operation complete

Performing Manual Output

- 1 Select an AO channel.
The channel information screen appears.

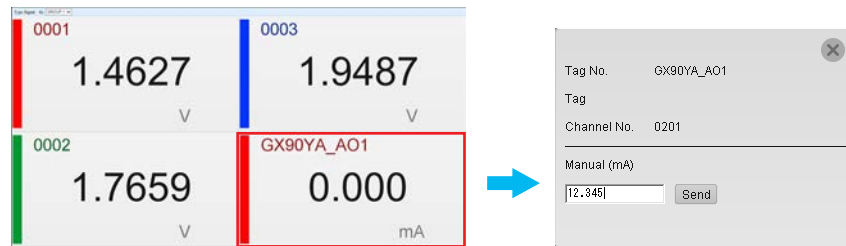

- 2 Set the output value, and select **Send**.
The specified value is output.

Operation complete

Collective AO Channel Operation from the Monitor

You can turn on and off the AO channels assigned to retransmission output at once. Users whose Output operation under User property in the security settings is set to LOCK cannot operate AO channels.

Turning Retransmission Output On or Off at Once

- 1 On the **Operation** tab, select **All re-transmission ON/OFF**.
The All re-transmission ON/OFF dialog box appears.

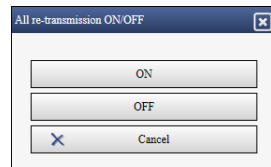

- 2 Select **ON** or **OFF**.
The selected value (ON or OFF) takes effect.

Operation complete

Displaying the Internal Switch Status and Changing the Values

You can display the internal switch status of the entire system. You can change the values of internal switches that are set to Manual.

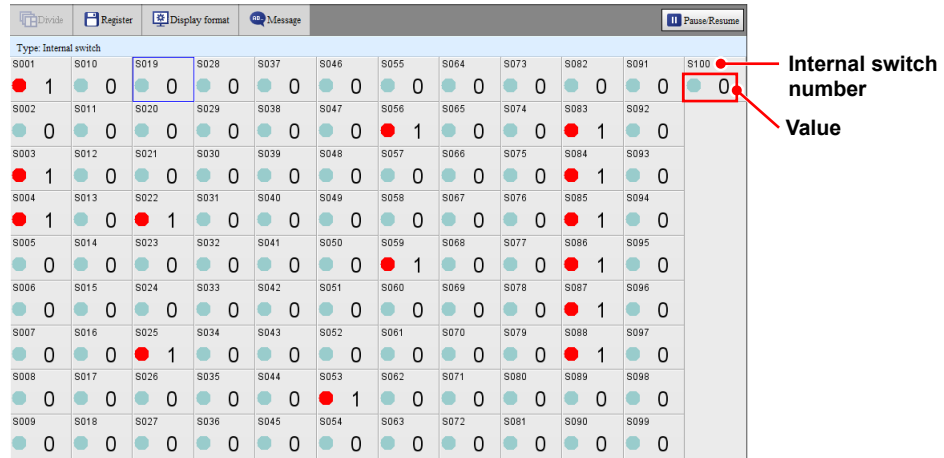

- Up to 100 internal switches can be displayed. When the display area of each channel becomes small, some of the information will not be displayed.
- The display is updated every second.

Changing the Internal Switch Values (Internal switches set to Manual)

Click an internal switch area to display a channel information dialog box of that switch. You can change the internal switch value from the channel information dialog box.

Checking the Command Status of the Modbus Client and Modbus Master

Click the **Data** tab and then **Modbus client** or **Modbus master** to display the command operating status. The display is updated every 5 seconds.

Communication Condition

The following settings are displayed. The setting display varies between Modbus client and Modbus master.

Function	Setup Item	Display
Modbus client	Wait time	Auto recovery
Modbus master	Interval	Read cycle
	Communication timeout	Time out
	Retransmission	Retrials
	Wait time	Auto recovery

Communication Status

▶ See “Modbus log” on page 3-30.

Resuming Command Transmission

You can use the display interface (click **Refresh**) to resume command transmission to a server to which communication is stopped (red status lamp).

Data When Communication Is Stopped and during Connection Retrials

If the command transmission stops such as due to a connection drop, the status turns orange or red, and the communication channel data is held at the previous value or is reset.

Data Dropout

Data drop occurs when the commands from 1 to 100 from the GM10-1 or from 1 to 200 from the GM10-2 do not complete within the read cycle. When a data dropout occurs, the communication channel data is held at the previous value. If this happens, take measures such as making the read cycle longer or reducing the number of commands. Confirm that no data dropout occurs on the Modbus status log screen.

WT Client Status

You can display the connection status with the WT power meter. For details on the displayed information, see the WT Communication (/E2) User's Manual (IM 04L51B01-19EN). The display is updated every 5 seconds.

Listing and Saving the Measured Data in the Internal Memory

You can display a list of the measured data (display data and event data) in the internal memory.

- Select the type of data to display using the **Data type** list box.
- When the measurement mode is set to **Dual interval**, the display can be switched between **Event data 1** and **Event data 2**.
- Click a column title to sort the items in ascending or descending order of that column.

Start time	Stop time	Number of data	Factor	File name
2015/05/13 08:32:30	2015/05/13 09:36:07	3818	Stop	001158_150513_083230.GEV
2015/05/13 08:32:29	2015/05/13 08:32:29	1	Auto save	001157_150513_083229.GEV
2015/05/12 16:00:01	2015/05/12 17:57:02	7022	Power off	001156_150512_160001.GEV
2015/05/12 12:00:01	2015/05/12 16:00:00	14400	Auto save	001155_150512_120001.GEV
2015/05/12 08:33:21	2015/05/12 12:00:00	12400	Auto save	001154_150512_083321.GEV
2015/05/12 08:33:20	2015/05/12 08:33:20	1	Auto save	001153_150512_083320.GEV
2015/05/11 16:00:01	2015/05/11 18:12:01	7921	Power off	001152_150511_160001.GEV
2015/05/11 12:00:01	2015/05/11 16:00:00	14400	Auto save	001151_150511_120001.GEV
2015/05/11 08:31:45	2015/05/11 12:00:00	12496	Auto save	001150_150511_083145.GEV
2015/05/11 08:31:44	2015/05/11 08:31:44	1	Auto save	001149_150511_083144.GEV
2015/05/08 16:00:01	2015/05/08 18:00:33	7233	Power off	001148_150508_160001.GEV
2015/05/08 12:00:01	2015/05/08 16:00:00	14400	Auto save	001147_150508_120001.GEV
2015/05/08 08:18:42	2015/05/08 12:00:00	13279	Auto save	001146_150508_081842.GEV
2015/05/08 08:18:41	2015/05/08 08:18:41	1	Auto save	001145_150508_081841.GEV
2015/05/07 16:00:01	2015/05/07 19:16:53	11813	Power off	001144_150507_160001.GEV
2015/05/07 12:00:01	2015/05/07 16:00:00	14400	Auto save	001143_150507_120001.GEV
2015/05/07 08:06:06	2015/05/07 12:00:00	14035	Auto save	001142_150507_080606.GEV
2015/05/07 08:06:05	2015/05/07 08:06:05	1	Auto save	001141_150507_080605.GEV

Saving All Data

You can save the internal memory's display data, event data, manual sampled data, and report data.

- 1 Click **All save**.
A Memory data save dialog box appears.
- 2 Click a button to specify the save destination.
The data is saved.

Saving Selected Data

- 1 Select the data you want to save from the list.
- 2 Click **Select save**.
A Memory data save dialog box appears.
- 3 Click a button to specify the save destination.
The data is saved.

Downloading Data

You can download the selected data to your PC.

- 1 Select the data you want to download.
- 2 Click **Download**.
Follow the instructions in the dialog box that appears.

Listing and Saving Report Data

You can display a list of the report data in the internal memory.

- Select the type of report data to display from the **Report type** list box.
- Click a column title to sort the items in ascending or descending order of that column.

Channel No.	Status	Ave	Max	Min	Sum	h
0001 [V]		0.0071	0.4999	-0.5000	2.207999E+01	1
A001 [°C]		15.1	23.0	5.0	4.706981E+04	3
A002 [kPa]		50.3	70.0	30.0	1.563196E+05	3
A003 [°C]		85.1	45.0	25.0	1.092498E+05	2
A004 [m3/h]		90.3	110.0	70.0	2.806796E+05	7
A005 [°C]		55.1	65.0	45.0	1.714298E+05	4
A006 [kPa]		130.3	150.0	110.0	4.050366E+05	1
A007 [°C]		75.1	85.0	65.0	2.334098E+05	6
A008 [°C]		85.1	95.0	75.0	2.646998E+05	7
A011 [°C]		10.1	20.0	0.0	3.152481E+04	0

Saving the Report Data

- 1 Click **Save**.
A Report data save dialog box appears.
- 2 Click a button to specify the save destination.
All the report data is saved.

Listing and Saving Manual Sampled Data

You can display a list of the manual sampled data in the internal memory.

- Click a column title to sort the items in ascending or descending order of that column.

Time	0001[V]	A001[°C]	A002[kPa]	A003[°C]	A004[m3/h]	A005[°C]	A006[...]
2014-01-09 16:04:04	0.0487	16.0	51.9	36.0	91.9	56.0	1
2014-01-09 16:04:13	0.1927	18.9	57.7	38.9	97.7	58.9	1
2014-01-09 16:16:09	-0.3913	7.2	34.3	27.2	74.3	47.2	1
2014-01-09 16:16:23	-0.4848	5.3	30.6	25.3	70.6	45.3	1
2014-01-09 16:17:49	0.3911	22.8	65.6	42.8	105.6	62.8	1
2014-01-09 16:19:33	-0.4232	6.5	33.1	26.5	73.1	46.5	1

Saving Manual Sampled Data

- 1 Click **Save**.
A Manual sample data save dialog box appears.
- 2 Click a button to specify the save destination.
All the manual sampled data is saved.

Network Information Monitor

The network information monitor displays the network information of connected instruments.

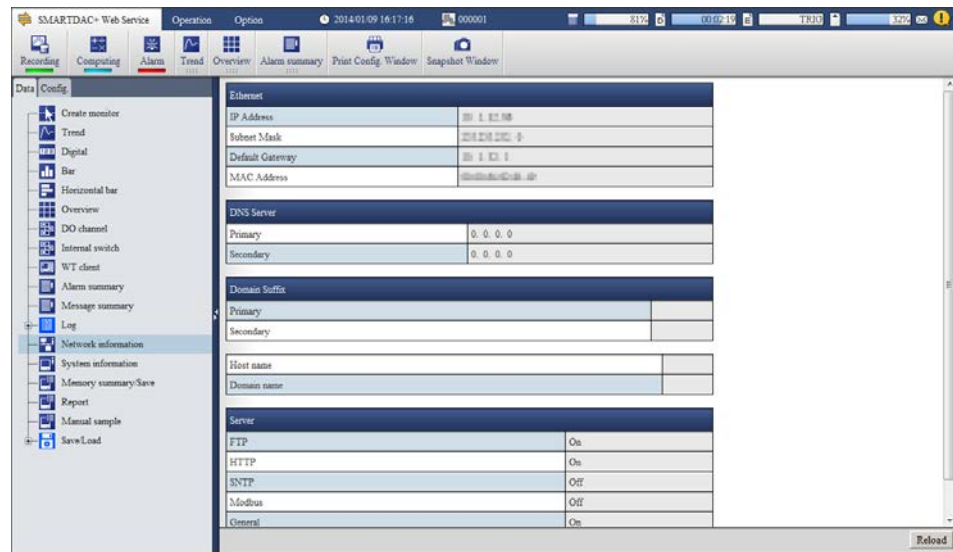

Click **Reload** (in the lower right of the screen) to update the displayed network information.

Note

If the Bluetooth options is available, the GM10's BD address is displayed.

If the GM10's BT lamp has never been turn on, the BD address will be displayed as "....."

After turning on the BT lamp, click **Reload** to reload the network information monitor.

System Information Monitor

The system information monitor displays the GM’s basic information, such as the number of channels, and the module configuration.

The following figure is for when only the main unit is available. If a sub unit is also available, the screen will consist of a System Info tab, Unit Info tab, and Module Info tab.

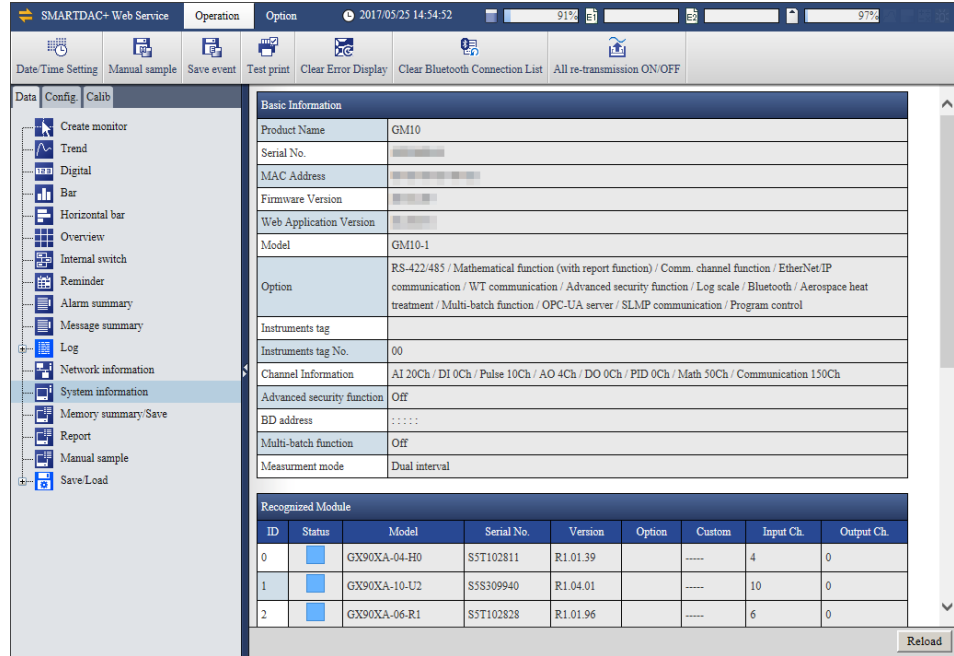

Click **ReLoad** (in the lower right of the screen) to update the information under **Connected module**.

Recognized Module and Connected Module

Recognized module shows the module configuration that the GM has detected.





Connected module shows the module configuration that is actually connected to the GM. To align **Recognized module** with **Connected module**, you must perform reconfiguration on the GM.

The **Special Order** column is fixed to **Standard**. The **Status** column shows maintenance information.

Note

- If the Bluetooth options is available, the GM10’s BD address is displayed. If the GM10’s BT lamp has never been turn on, the BD address will be displayed as “.....” After turning on the BT lamp, reload the system information monitor.
- If the expansion module is turned off and then back on, the connection status is changed. Reload.

Displayed Content

Item	Description
System information	Product Name (GM10)
	Serial No.
	MAC Address
	Firmware Version
	Web Application Version
	Model
	Option
	Instruments tag
	Instrument tag No.
	Channel Information
	Advanced security function: Option, /AS usage
	BD address: Displayed when Bluetooth function (/C8) is in use
	Multi-batch function: Displayed on models with the /BT option
	Measurement mode
	Connected module
	Connected module (single unit system)
	A list of modules connected to the main unit is displayed.
	Unit list (multi unit system)
	A list of detected units and connected units is displayed.
	Status indication
Icon	Description
	The module is operating normally.
	An error is occurring in the module.
	A critical error is occurring in the module.
	The module that is recognized does not match the module that is connected.
(Blank)	No modules are connected or recognized.
Unit information	A list of detected units* and connected units* is displayed. The displayed items are model, serial number, version, options, tokuchu, and errors. The status indication icons and descriptions are the same as those of system information. * GM10 and GX90EX
Module information	A list of detected modules and connected modules is displayed. There is a Main unit tab and a Unit No. tab. The displayed items are model, serial number, version, options, tokuchu, input channels, output channels, and errors. The status indication icons and descriptions are the same as those of system information.

Activating Modules (When using the advanced security function (/AS option))

If modules that need to be activated are installed, "Module activation" appears under the system information.

- For details on module activation, see section 2.1.9, "Activating Modules," in the Advanced Security Function (/AS) User's Manual (IM 04L55B01-05EN).

Printing the Settings

You can print the GM settings.

On the **SMARTDAC+ Web Service** tab, click **Print Config. Window**.

The setup print window appears.

Setting								
PC time	2014/12/05 18:07:22							
Hardware time	2014/12/05 18:07:28							
Comment								
System Information								
Basic Information								
Product Name	GM10							
Serial No.	123456789							
MAC Address	00-00-64-92-a3-f3							
Firmware Version	R.2.02.96							
Main Program	R.2.02.96							
Web Program	R.2.01035							
Model	GM10-2							
Option	Mathematical function (with report function) / Com m. channel function / EtherNet/IP communication / WT communication / Log scale / Bluetooth							
Instruments tag								
Instruments tag No.								
Channel Information	AI 20Ch / DI 16Ch / DO 6Ch / Math 100Ch / Communic ation 500Ch							
BD address	: : : :							
Recognized Module								
ID	Status	Model	Serial No.	Version	Option	Custom	Input Ch.	Output Ch.
0	GOOD	GX90XA-10-U2	\$5M807738	R1.04.56		-----	10	0
1	GOOD	GX90XA-10-U2	\$5N510012	R1.04.56		-----	10	0
2	GOOD	GX90XD-16-11		R1.04.56		-----	16	0
3	GOOD	GX90YD-06-11		R1.04.56		-----	0	6
4	----	----	----	----	----	-----	-----	-----
5	----	----	----	----	----	-----	-----	-----
6	----	----	----	----	----	-----	-----	-----
7	----	----	----	----	----	-----	-----	-----
8	----	----	----	----	----	-----	-----	-----
9	----	----	----	----	----	-----	-----	-----
Connected Module								
ID	Model	Serial No.	Version	Option	Custom	Input Ch.	Output Ch.	Error
0	GX90XA-10-U2	\$5M807738	R1.04.56		-----	10	0	

- You can enter a comment in the Comment box.
- Items whose check boxes are selected under **Print setting** will be printed. Clear the check boxes for the items you do not want to print.
- The password is displayed using asterisks.
- Click the browser's Refresh button to refresh the displayed information.
- The information is displayed in the specified display language (see page 3-41 in section 3.1.3, "Changing the Display Settings on the Browser").

Print using the browser's print feature.

Note

- The setup print window will work properly only when it is opened from the Web application. When you close the Web application, close also the setup print window.
- When printing, if the layout appears broken at the page switching point, print in the IE mode of Microsoft Edge.

3.1.3 Changing the Display Settings on the Browser

You can change the display language on the browser and add and delete monitor display switch buttons on the menu bar.

- 1 On the **Option** tab, click **Web Option**.
A Web Option dialog box appears.
- 2 Change the settings, and click **OK**.

For procedure to change the settings, see the explanation below.

The screenshot shows the 'Web Option' dialog box with the following sections:

- Display Settings:**

Language	English	Sync with the hardware
Date Format:Format	Year Month Day	Sync with the hardware
Date Format:Delimiter	/	Sync with the hardware
Month Indicator	Numerical	Sync with the hardware
Decimal Point Type	Point	Sync with the hardware
- Jump Buttons:**

Button1	Trend
Button2	Overview
Button3	Alarm summary
Button4
Button5
- Audio setting:**

Alarm sound	OFF
-------------	-----

Buttons: OK, Cancel

Language

Select the language from the list. Click **Get info. from Hardware** to obtain the setting from the GM and reflect it in the text box.

Note

- If you change the language, the Web application will restart.
- The language and date format are according to the browser display format and are different from the GM settings.
 - ▶ For the GM settings, see page 2-180 in section 2.26.1, "Setting the Display Language, Temperature Unit, Decimal Point Type, and Date Format".

Date Format: Format

Select the format from the list. Click **Get info. from Hardware** to obtain the setting from the GM and reflect it in the text box.

Date Format: Delimiter

Select the delimiter for the year, month, and day from the list. Click **Get info. from Hardware** to obtain the setting from the GM and reflect it in the text box.

Month Indicator

To display the month as words, select the check box. Click **Get info. from Hardware** to obtain the setting from the GM and reflect it in the check box. You cannot select this setting when the language is set to Japanese, Chinese, or Korean.

Display Type of Decimal Point

Select the decimal point type from the list. Click **Get info. from Hardware** to obtain the setting from the GM and reflect it in the text box.

Control settings

Display background

Set the display background to **White** or **Black**. Click **Get info. from Hardware** to obtain the setting from the GM and reflect it in the text box.

Jump Buttons

Button 1 to Button 5

You can add up to five monitor display switch buttons to the menu bar. From the **Button1** to **Button5** lists, select the monitor display switch buttons you want to add. Select ----- if you do not want to specify a jump button.

Audio setting

Alarm Sound

If you select ON, the PC will generate an alarm sound when an alarm occurs.

- This function is enabled when in **System settings**, under **Alarm basic settings**, Indicator's **Hold/Nonhold** is set to **Hold**.
- The alarm sound stops when you acknowledge the alarm on the GM or Web application.

Note

In Chrome, you have to click on the screen 1 or more times to play the alarm. To configure Chrome to play without having to click, do the following:

1. Type the following into the Chrome address bar and then press Enter.
chrome://flags/#autoplay-policy
2. Under Autoplay policy, select No user gesture is required.

3.1.4 Changing the Password

The user that is logged in can change his or her password.

- 1 On the **Option** tab, click **Password change**.
A Password change dialog box appears.

- 2 Enter the password, and click **Update**.
The password will be changed. Use the new password for subsequent logins.

User name	User01
Old Password	
New Password	
New Password Again	

Update
Cancel

3.2 Transmitting E-mail Messages

This section explains how to configure e-mail transmission settings.

3.2.1 Configuring the SMTP Client Function

The SMTP client function is used to send E-mail from the GM.

Description

- **Enable the SMTP client function**
 - **Set the user authentication method**
Set the authentication method when user authentication is necessary.
 - **Specify the SMTP server settings**
 - **Specify the POP3 server settings**
Specify the necessary settings when the user authentication method is POP3 (POP before SMTP).
- ▶ For details on the settings, see page 2-158 in section 2.22.3, “Configuring the SMTP Client Function”.

3.2.2 Setting the Mail Content

Description

- **Set the mail header**
 - **Set the mail content**
 - **Set alarm notification mail**
Specify the necessary settings to send e-mails when alarms occur and are released.
 - **Set report generation notification mail**
Specify the necessary settings to send e-mails when reports are generated.
 - **Set periodic mail**
Specify the necessary settings to send periodic e-mails .
 - **Send mail when the power is turned on, when the GM recovers from a power failure, when the memory is full, or when an error occurs**
- ▶ For details on the settings, see page 2-159 in section 2.22.4, “Setting E-mail Transmission Conditions (When the SMTP client function is on)”.

Explanation

Transmitting E-mail Messages

The available types of e-mails are listed below. E-mail can be automatically transmitted for each item. You can specify two groups of destinations and specify the destination for each item. In addition, you can set a header string for each item.

- Alarm notification mail
Sends alarm information when an alarm occurs or clears or reports alarm information only when an alarm occurs.
When the measurement mode is Dual interval, there is no distinction as to whether the alarm occurred on measurement group 1 or measurement group 2.
- Power failure notification mail
Sends the time of power failure and time of recovery when the GM recovers from a power failure.
- Memory full notification
Sends a message when the free space on the external storage medium or internal memory is low.
- System error notification mail
Sends an error code and message when an external storage medium error, internal memory error, or FTP client error occurs.
- Periodic notification mail
Sends a message when the specified time is reached. This can be used to confirm that the e-mail transmission function including the network is working properly. You can specify the reference time and the e-mail transmission interval for each destination.
- Report notification mail (only on models with the math function (/MT option))
Sends report results.
- User lockout notification mail (only on models with the advanced security function (/AS option))
Sends a list of invalidated users.
- Health score notification email
Notifies you when your health score falls below the early notification threshold (early notification) or when your health score falls below 0 (NG notification).

Example of an e-mail sent periodically

<pre>Date: Wed, 10 Nov 2014 08:00:45 +0900 (JST) [From: GM10@smartdacplus.com To: user1@smartdacplus.com, user2@daq.co.jp Subject: [Periodic data] subject MIME-Version: 1.0 Content-Type: text/plain; charset="iso-2022-jp" Content-Transfer-Encoding: 7bit TEMPERATURE Periodic notification <Host name> GM10 <Time> 2014/12/19 08:00:01</pre>	<p>Subject</p> <p>Header 1</p>
---	--

3.2.3 Performing an Mail Transmission Test

▶For the procedure, see “Starting, Stopping, and Testing Mail Transmission” on page 3-4.

3.2.4 Starting and Stopping E-mail Transmission

▶For the procedure, see “Starting, Stopping, and Testing Mail Transmission” on page 3-4.

3.2.5 E-mail Format

The formats of alarm notification mail, periodic notification mail, power failure notification mail, memory full notification mail, system error notification mail, report notification mail, test mail, user lockout notification (on models with the advanced security function (/AS option)), early notification (release number 5 and later), NG notification (release number 5 and later) are given below.

Alarm Notification Mail Format

• Subject	Subject	[Alarm_Summary]sss···s-ttt···t
• Syntax	Header block	headerCRLF CRLF
	General block	Alarm_notificationCRLF <Host name>CRLF hostCRLF CRLF
	Alarm information	<CH>ccc···cCRLF <Type>lqCRLF <aaa>yyyy/mo/dd_hh:mi:ssCRLF CRLF : CRLF
	Instantaneous data	<Inst. value>CRLF yyyy/mo/dd_hh:mi:ssCRLF ccc···c=ddd···duuu···uCRLF : CRLF
	Source URL	Access_the_following_URL_in_order_to_look_at_a_screen.CRLF http://host.domain/CRLF CRLF
	Display item description	
	ttt···t	Tag number or channel number (when tag or channel is attached to the header)
	ccc···c	Tag number, tag, or channel number (Channels set to skip or off are not output.)
	lq	Alarm level (1 to 4) Alarm type (H, L, R, r, T, t, h, l, F, f) H (high limit alarm), L (low limit alarm), R (high limit on rate-of-change alarm), r (low limit on rate-of-change alarm), T (delay high limit alarm), t (delay low limit alarm), h (difference high limit alarm), l (difference low limit alarm), F (profile high limit alarm), f (profile low limit alarm)
	aaa	Alarm status (On, Off)
	ddd···d	Measured value, computed value (up to 10 digits including the sign and decimal point) +OVER (positive overflow) -OVER (negative overflow) Burnout ***** (error data)

The GM transmits channel numbers, alarm types, and alarm statuses for up to 10 events in a single e-mail. If the GM is configured to include a tag number or a channel number in the e-mail subject, one e-mail is sent for each event.

Periodic Notification Mail Format

- **Subject**
 Subject [Periodic_data]sss...s

- **Syntax**
 - Header block headerCRLF
 CRLF
 - General block Periodic_notificationCRLF
 <Host name>CRLF
 hostCRLF
 CRLF
 - Time information <Time>CRLF
 yyyy/mo/dd_hh:mi:ssCRLF
 CRLF
 - Cancellation information E-mail message(s) did not reach intended recipient(s). CRLF
 [ttt...t]CRLF
 Count = nnn...nCRLF
 yyyy/mo/dd_hh:mi:ssCRLF
 CRLF
 :
 - Instantaneous data <Inst. value>CRLF
 yyyy/mo/dd_hh:mi:ssCRLF
 ccc...c=ddd...duuu...uCRLF
 :
 - Source URL Access_the_following_URL_in_order_to_look_at_a_screen. CRLF
 http://host.domain/CRLF
 CRLF

- Display item description**
 - ccc...c Tag number, tag, or channel number
 (Channels set to skip or off are not output.)
 - ttt...t Canceled mail type
 Alarm_summary (alarm notification mail)
 Periodic_data (periodic notification mail)
 System_warning (system error notification mail)
 Power_failure (power failure notification mail)
 Memory_full (memory full notification mail)
 Report_data (report notification mail)
 Health_score (health score notification mail)
 - nnn...n Number of canceled mails
 - ddd...d Measured value, computed value (up to 10 digits including the sign
 and decimal point)
 +OVER (positive overflow)
 -OVER (negative overflow)
 Burnout
 ***** (error data)

The time that follows the type and count of canceled mails is the time when the mail is canceled last.

Power Failure Notification Fail Format

- Subject
Subject [Power_failure]sss...
- Syntax

Header block	headerCRLF CRLF
General block	Power failure notificationCRLF <Host name>CRLF hostCRLF CRLF
Power supply information	<Power_failure>CRLF yyyy/mo/dd_hh:mi:ssCRLF CRLF <Power_recovery>CRLF yyyy/mo/dd_hh:mi:ssCRLF CRLF
Source URL	Access_the_following_URL_in_order_to_look_at_a_screen.CRLF http://host.domain/CRLF CRLF

Memory Full Notification Mail

- Subject
Subject [Memory_full]sss...
- Syntax

Header block	headerCRLF CRLF
General block	Memory full notificationCRLF <Host name>CRLF hostCRLF CRLF
Memory information	yyyy/mo/dd_hh:mi:ssCRLF <Memory_remain>ppp...pMbytesCRLF <File number>bbb/500CRLF <Medium_remain>rrr...rMbytesCRLF CRLF
Source URL	Access_the_following_URL_in_order_to_look_at_a_screen.CRLF http://host.domain/CRLF CRLF
- Display item description**

ppp...p	Remaining space in internal memory
bbb	Number of unsaved files (0 to 500)
rrr...r	Remaining space on external storage medium

System Error Notification Mail Format

- **Subject**
Subject [System_warning]sss...s
- **Syntax**
Header block headerCRLF
CRLF
General block System error notificationCRLF
<Host name>CRLF
hostCRLF
CRLF
Error information yyyy/mo/dd_hh:mi:ssCRLF
<ERROR>fffCRLF
mmm...mCRLF
CRLF
Source URL Access_the_following_URL_in_order_to_look_at_a_screen.CRLF
http://host.domain/CRLF
CRLF
Display item description
fff Error number
(234, 501, 502, 507, 511, 692, 693, 695, 696, 698, 699, 921)
mmm...m Error message

The error message varies depending on the error type.

Report Notification Mail Format

- Subject
 - Subject [rrr...r]sss...s

- Syntax
 - Header block headerCRLF
 CRLF
 - General block tiCRLF
 <Host name>CRLF
 hostCRLF
 CRLF
 - Report information yyyy/mo/dd_hh:mi:ssCRLF
 <CH>ccc...cCRLF
 <tp>eee...eCRLF
 <tp>eee...eCRLF
 <tp>eee...eCRLF
 <tp>eee...eCRLF
 <tp>eee...eCRLF
 <Unit>uuu...uCRLF
 CRLF
 :
 CRLF
 - Source URL Access_the_following_URL_in_order_to_look_at_a_screen. CRLF
 http://host.domain/CRLF
 CRLF

- Display item description**
 - rrr...r Report mail content (Hourly report, Daily report, Weekly report, Monthly report, Batch report, Daily custom report)
 - ti Report mail content (hourly, daily, weekly, monthly, batch, and daily-custom)
 - tp Report content (average, maximum, minimum, sum, and instantaneous; five items from these are output)
 - ccc...c Tag number, tag, or channel number (Channels set to off are not output.)
 - eee...e Measured value, computed value (up to 10 digits including the sign and decimal point). However, for the sum value, the value is output as a combination of the sign, mantissa, E, sign, and exponent such as in -3.800000E+02.
 +OVER (positive overflow)
 -OVER (negative overflow)
 ***** (error data)

Test Mail Transmission Format

- Subject
 Subject [Test]sss...s
- Syntax
 - Header block headerCRLF
CRLF
 - General block Test_mailCRLF
<Host name>CRLF
hostCRLF
CRLF
 - Time information <Time>CRLF
yyyy/mo/dd_hh:mi:ssCRLF
CRLF

User Lockout Notification Format

- Subject
 Subject [User_lockout]sss...s
- Syntax
 - Header block headerCRLF
CRLF
 - General block User_lockout_notificationCRLF
<Host name>CRLF
hostCRLF
CRLF
 - User lock out information yyyy/mo/dd_hh:mi:ssCRLF
<User name>CRLF
uuu...uCRLF
:
CRLF
 - Source URL Access_the_following_URL_in_order_to_look_at_a_screen.CRLF
http://host.domain/CRLF
CRLF
 - Display item description
uuu...u User name

Early Notification Format

- Subject
 Subject [Health_score]sss...s
- Syntax
 - Header block headerCRLF
CRLF
 - General block Early_notificationCRLF
<Host name> or <IP address>CRLF
hostCRLF
CRLF
 - Health score information yyyy/mo/dd_hh:mi:ssCRLF
<Early notification threshold>fff...fCRLF
<Health score>ccc...cCRLF
CRLF
 - Source URL Access_the_following_URL_in_order_to_look_at_a_screen.CRLF
http://host.domain/CRLF
CRLF
 - Display item description
fff...f Health score threshold
ccc...c Health score

NG Notification Format

- Subject
Subject [Health_score]sss...s
- Syntax
 - Header block headerCRLF
CRLF
 - General block NG_notificationCRLF
<Host name> or <IP address>CRLF
hostCRLF
CRLF
 - Health score information yyyy/mo/dd_hh:mi:ssCRLF
<Health score>ccc...cCRLF
CRLF
 - Source URL Access_the_following_URL_in_order_to_look_at_a_screen.CRLF
http://host.domain/CRLF
CRLF
- Display item description**
ccc...c Health score

Display Items Common to All Formats

sss...s	Subject
uuu...u	Unit
YYYY	Year (2001 to 2035)
mo	Month (01 to 12)
dd	Day (01 to 31)
hh	Hour (00 to 23)
mi	Minute (00 to 59)
ss	Second (00 to 59)
header	Header
host	Host name or IP address (IP address when the host name is not assigned.)
domain	Domain name
—	Space
CRLF	Line feed

Channel Number Notation and Range

Type	Model	Notation and Range	Notes
I/O channel	GM10	0001 to 0999 ¹	Depends on the installed module
	Sub unit	1001 to 6599	
Math channel	GM10	A001 to A100	/MT option
Report channel	GM10	R01 to R60	/MT option
Communication channel	GM10-1	C001 to C300	/MC option
	GM10-2	C001 to C500	

¹ 0001 to 0899 when a sub unit is connected

3.3 Accessing the Measurement Data File on the GM from a PC (FTP server function)

You can use a PC to access the GM via FTP. You can perform operations such as retrieving directory and file lists from the external storage medium (SD card) of the GM and transferring and deleting files. In addition, you can also retrieve the directory or file list and transfer files in the internal memory.

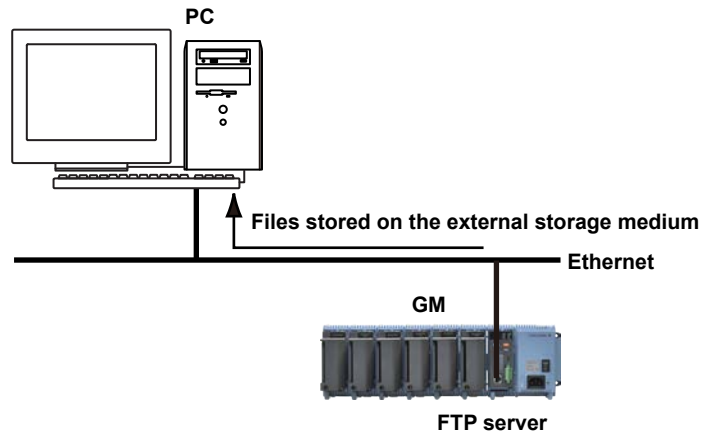

3.3.1 Configuring FTP Server Settings

Description

- Enable the FTP server function
 - Set the FTP server directory output format
- For details on the settings, see page 2-168 in section 2.22.9, “Setting the Server Functions to Use (FTP, HTTP, SNTF, MODBUS, GENE, DARWIN compatible communication)”.

3.3.2 Accessing the GM from a PC

When Not Using the Login Function

Access the GM from a PC via FTP using the admin, user, or anonymous account.

With the admin account, you can

- Retrieve directory and file lists from the external storage medium and transfer and delete directories and files on the external storage medium.
- Retrieve directory and file lists from the internal memory and transfer directories and files in the internal memory.

With the user or anonymous account, you can

- Retrieve directory and file lists from the external storage medium.

Connecting from a PC via the FTP

An example of retrieving files using a browser is described below. In the Address box, enter ftp://host name.domain name. Drag the data you want to retrieve from the /MEM0/DATA folder in the case of internal memory data or the /DRV0 folder in the case of data on the external storage medium to the PC. You can also use the IP address in place of the “host name.domain name.”

When Using the Login Function (Standard)

In the URL box, enter ftp://user name@host name.domain name/.

- Internal memory: ftp://username@hostname/MEM0/DATA
- External media: SD memory card: ftp://username@hostname/DRV0/

You will be prompted for a user name and password when you access the server. Enter a user name and password that are registered on the GM to connect to it.

To specify the password, append [:password] to the user name.

Example: ftp://username:password@hostname/MEM0/DATA

Note

- **Memory** is linked to ftp://hostname/MEM0/DATA.
- **External media: SD card** is linked to ftp://hostname/DRV0/.
- You cannot retrieve data files that are being created.
- You must access using “ftps://” when SSL encryption is in use.

3.4 Transferring Data Files from the GM (FTP client function)

The display data, event data, report data, alarm summary data, manual sample data, setting parameter (/AS) when changing settings, and health monitor log files that are created in the internal memory of the GM can be automatically transferred via FTP when the files are created.

You can specify two file transfer destinations (FTP servers): primary and secondary. If the primary FTP server is down, the file is transferred to the secondary FTP server. If the report template function is in use, report files in Excel format and report files in PDF format that are created in the external storage medium of the GM can be automatically transferred when the files are created.

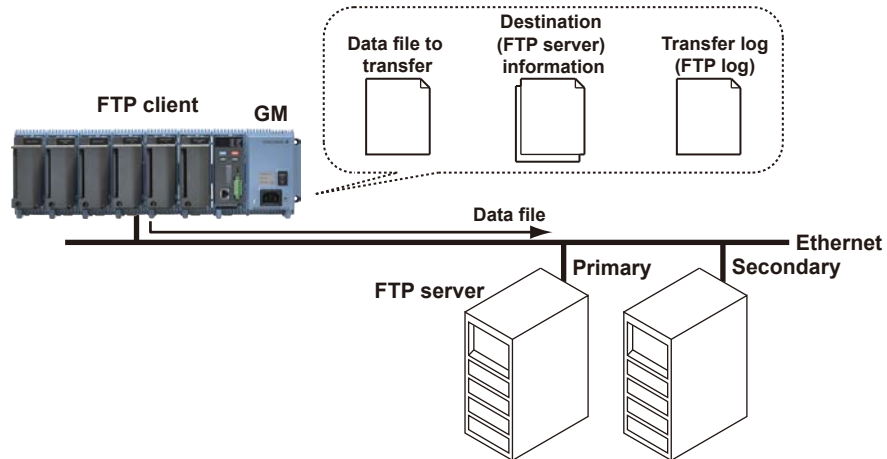

3.4.1 Configuring the FTP Client Function

Description

Enable the FTP client function

Set the files to transfer

Set the files that will be transferred automatically.

- **Set the transfer wait time**

Set the transfer wait time if you want to delay data transfers to the FTP server.

- **Set the destinations (primary and secondary)**

Set the connection destination FTP servers.

- ▶ For details on the settings, see page 2-156 in section 2.22.2, "Configuring the FTP Client Function".

Explanation

Files to Transfer via FTP

Data other than Excel report files and PDF report files are automatically transferred regardless of whether the external storage medium is available.

File Type	Description
Display data file	Data files are automatically transferred at each file save interval.
Event data file	Files are automatically transferred when the data length of data is recorded.
Report data file	When the file division mode is Separate or Combine , data files are automatically transferred when a report file is closed (or divided). For example, data files are automatically transferred once per month for daily+monthly reports when the file division mode is Combine . Report data files based on report templates (Excel report file, PDF report file) are also automatically transferred when they are created. ¹ ▶For details on Separate and Combine , see page 2-124 in section 2.17.1, "Setting the Report Type, Creation Time, Data Type, Etc."
Alarm summary data file	Files are automatically transferred when alarms are saved.
Manual sample data file	Files are automatically transferred when the next time manual sample is executed ² and the file is divided.
Setting file at the time of the setting change	The setting file in the SD memory card is automatically transferred when settings are changed. The files saved to the SD memory card are also automatically transferred when the profile trend is loaded. ^{1,3}
Health monitor log file * 1	Automatically forwards every time a health monitor log file is created.

- Files will not be transferred automatically if the remaining space on the SD card is low or if the SD card is not connected.
- Refers to an action triggered through communication command (OExecRec) or event action function.
- Only on models with the advanced security function (/AS option).

Shifting the Transfer Time

There may be cases when data cannot be transferred from the GM to the FTP server due to too many simultaneous connections to the FTP server. An example is when multiple files are created and need to be transferred at the same time from multiple GMs. By shifting the transfer time, you can avoid having too many simultaneous connections to the FTP server. You can shift the transfer time for display data files, event data files, and report files.

- Even if a new event that requires an FTP transfer occurs while the GM is waiting to transfer the data of the previous event, it does not affect the transfer wait time of the previous event. When the transfer shift time passes, all data files of the same type that have been created (all of the files that have not been transferred) are transferred via FTP. The following figure is an example for display data.
- To avoid accumulating too many files that have not been transferred, we recommend that you set the transfer wait time shorter than the interval at which events that require FTP transfers occur.

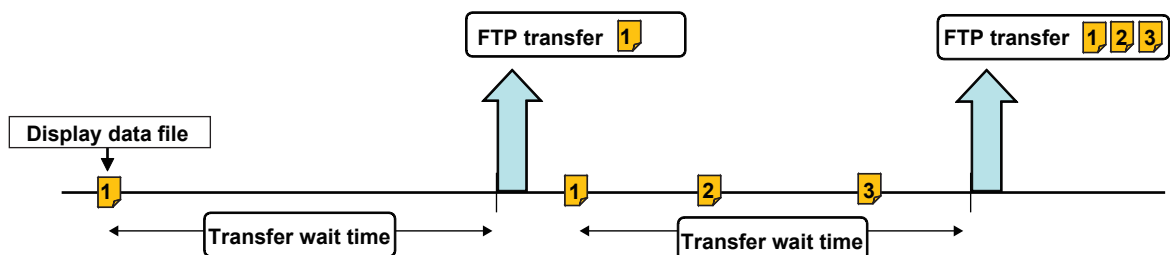

Transfer Operation

- Even if you turn the power off during FTP transfer wait time, the elapsed time is recorded.
- If you change the FTP transfer time settings during FTP transfer wait time, the data files that are being held are transferred using the previous setting. Subsequent data files are sent according to the new setting.
- If you execute FTP function to Off, or "Initialize all" during a FTP transfer wait time, the elapsed time is cleared.

When There Is a File with the Same Name at the Transfer Destination

Under all circumstances, when there is a file with the same name at the transfer destination, it is overwritten.

Operation When the Data Transfer Fails

If the GM fails to transfer files to both the primary and secondary FTP servers, the GM aborts the file transfer operation. When the new (next) data file becomes available, the GM transfer the new data file along with the files that the GM failed to transfer (except for alarm summary data files and manual sample data files). Note that because the GM transfers data from its internal memory, if the data that the GM failed to transfer is overwritten, it is lost.

3.4.2 Testing the FTP Transfer

You can check whether files can be sent from the GM to the FTP server using a test file.

- ▶ For the procedure, see "Executing a File Transmission Test on the FTP Server" on page 3-7.

3.5 Synchronizing the Time (SNTP client function)

The GM time can be synchronized to the time on an SNTP server (time information server on the network).

The GM can retrieve time information from a specified SNTP server at specified intervals. When recording is in progress, the time is gradually adjusted.

- ▶ See page 2-182 in section 2.26.4, “Setting the Time Zone, Gradual Time Adjustment, and Daylight Saving Time”.

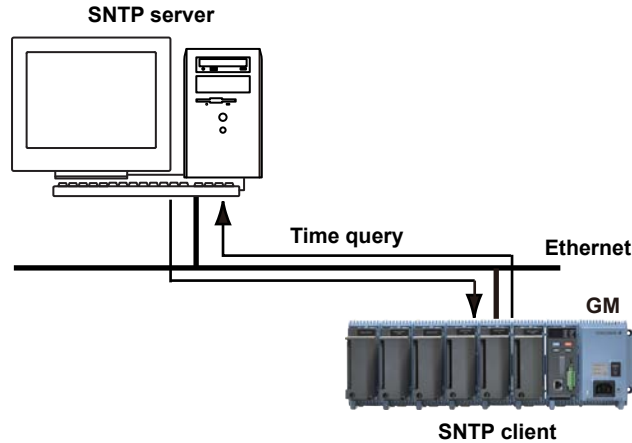

3.5.1 Configuring the SNTP Client Function

Description

- Enable the SNTP client function
- Specify the SNTP server settings
- Set the query operation

- ▶ For setup details, see page 2-162 in section 2.22.5, “Setting the SNTP Client Function”.

3.5.2 Adjusting the Clock Manually

Procedure

You can adjust the clock manually. The SNTP client must be enabled.

- ▶ For operating instructions, see “Changing the Time Using SNTP” on page 3-6.

3.6 Transmitting Time Information from the GM to SNTP Client Devices (SNTP server function)

The GM can operate as an SNTP server. When an SNTP client device on the network queries the GM for time information, the GM sends the information.

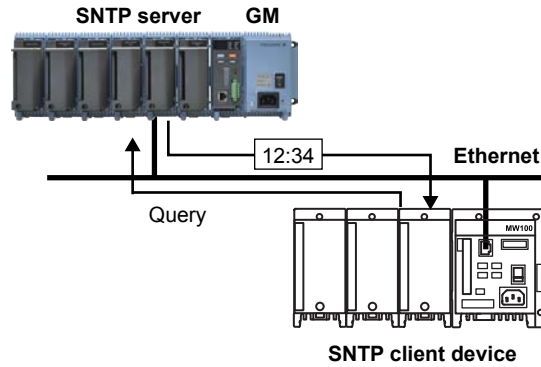

3.6.1 Configuring the SNTP Server Function

Description

Enabling the SNTP Server Function

- For details on the settings, see page 2-168 in section 2.22.9, "Setting the Server Functions to Use (FTP, HTTP, SNTP, MODBUS, GENE, DARWIN compatible communication)".

4.1 Using Modbus/TCP to Enable Other Devices to Read Data from and Write Data to the GM (Modbus server function)

The Modbus function is used by the GM and external Modbus devices to perform communication and data reading and writing.

The GM can operate as a Modbus server. The maximum number of simultaneous connections is 4.

Other devices (Modbus client devices) can carry out the following operations on the GM.

- Read I/O channel and math channel (/MT option) data
- Read communication channel (/MC option) data
- Write data to communication channels
- Start and stop recording, write messages, and perform other operations
- Load the recording start/stop condition, message strings, and other types of data

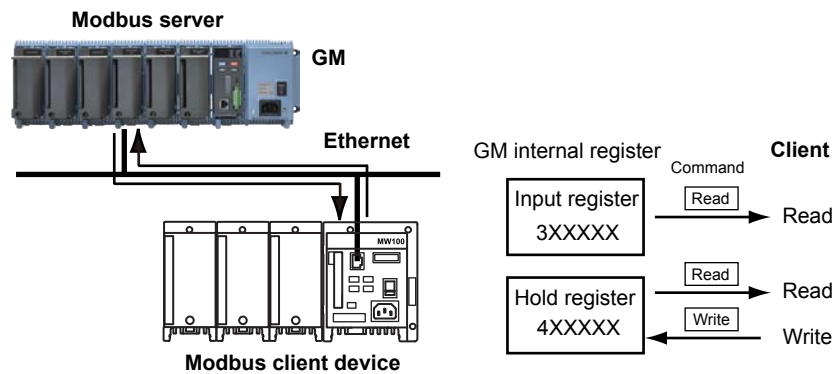

4.1.1 Setting Basic Network Communication Conditions

Description

- Obtain the IP address automatically
 - Set the IP address manually (when automatic IP address assignment is set to Off)
- ▶ For details on the settings, see page 2-154 in section 2.22.1, "Setting Basic Communication Conditions".

4.1.2 Configuring the Modbus Server Function

Description

Enabling the Modbus Server Function

- ▶ For details on the settings, see page 2-168 in section 2.22.9, "Setting the Server Functions to Use (FTP, HTTP, SNTP, MODBUS, GENE, DARWIN compatible communication)".

Applying Modbus Connection Limits

Set this function to limit the IP addresses that can connect to the GM Modbus server function.

You can register up to 10 IP addresses.

- ▶ For details on the settings, see page 2-167 in section 2.22.8, "Limiting the Connection to the Modbus Server (GM)".

4.1.3 Reading from and Writing to the GM from Other Devices

Other devices (client devices) can transmit commands to the GM to read data from and write data to the GM internal registers. By writing data to the GM internal registers, you can control the GM (such as start recording).

- ▶ For details on the function codes that the GM supports and the GM registers that client devices can access, see page 4-10 in section 4.5, “Modbus Function and Register Assignments”.

Specifying Register Numbers

On client devices, specify the GM registers as follows:

- If you are using a commercial SCADA system or something similar, specify the register number (a number such as 400001; referred to as the “reference number”) listed in ▶ page 4-10 in section 4.5, “Modbus Function and Register Assignments”.
- If you are using a custom communication program, specify the “relative number” in relation to the reference number. Derive the relative number in the manner indicated in the examples below.

Example

The relative number for input register 300100 is 99, which is the difference between 300100 and 300001.

$$300100 - 300001 = 99$$

The relative number for input register 400011 is 10, which is the difference between 400011 and 400001.

$$400011 - 400001 = 10$$

4.2 Using Modbus/TCP to Enable the GM to Read Data from and Write Data to Other Devices (Modbus client function)

The Modbus function is used by the GM and external Modbus devices to perform communication and data reading and writing.

The GM can operate as a Modbus client. The maximum number of connectable servers is 16 for the GM10-1 and 32 for the GM10-2.

The GM can connect to another device (Modbus server) via Modbus/TCP and read from and write to the device's internal registers. Read data can be handled using communication channels. Data that can be written are I/O channel data, math channel data, and communication channel data.

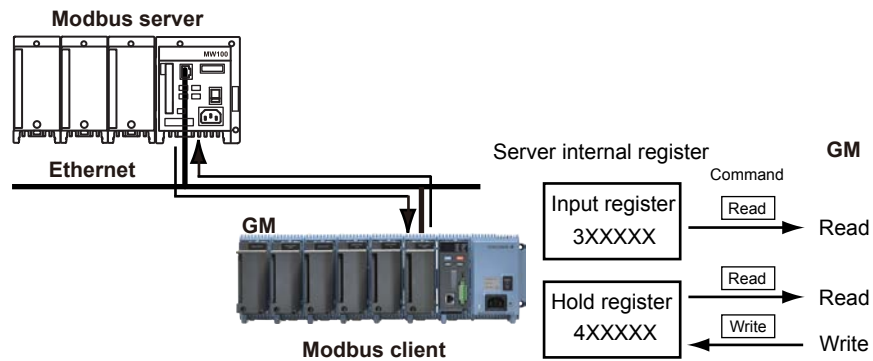

4.2.1 Setting Basic Network Communication Conditions

Description

- Obtain the IP address automatically
 - Set the IP address manually (when automatic IP address assignment is set to Off)
- ▶ For details on the settings, see page 2-154 in section 2.22.1, “Setting Basic Communication Conditions”.

4.2.2 Configuring the Modbus Client Function

Description

- Enable the Modbus client function
 - Set the communication interval
 - Set the recovery action
 - Set the keep connection function
- ▶ For details on the settings, see “Configuring Basic settings” page 2-163 in section 2.22.6, “Configuring the Modbus Client Function (/MC option)”.

4.2.3 Configuring the Destination Server

Description

- **Set the server number**
 - **Configure the server settings**
- ▶ For details on the settings, see “Configuring Basic settings” page 2-163 in section 2.22.6, “Configuring the Modbus Client Function (/MC option)”.

4.2.4 Setting Commands

Description

- **Set the client command number**
 - **Set the command**
- ▶ For details on the settings, see “Configuring Basic settings” page 2-163 in section 2.22.6, “Configuring the Modbus Client Function (/MC option)”.
- ▶ For details on the Modbus functions and registers that the GM supports, see page 4-10 in section 4.5, “Modbus Function and Register Assignments”.

Server Register Number

You can specify an input register in the range of 30001 to 39999 or 300001 to 365535. You can specify a hold register in the range of 40001 to 49999 or 400001 to 465535. The register numbers that you can specify vary depending on the type of command. ▶page 4-10 in section 4.5, “Modbus Function and Register Assignments”

Specifying Register Numbers

Specify the register number on the GM by using the “reference number” (such as the number 40001 written above). For example, for the YOKOGAWA UT35A digital indicating controller, the D register number corresponds to the reference number as shown in the following table.

D-Reg. No.	Ref. No.
D2001	42001

For a server that calls the register using a “relative number,” add 30001, 300001, 40001, 400001 or a similar number to obtain a reference number.

Register Type	Relative Number	Reference Number	Expression
Hold register	1004	41005	1004+40001
	14567	414568	14567+400001
Input register	0000	30001	0000+30001

Examples of Setting Commands

The following are command setting examples on the GM when the GM is a Modbus client device. If the GM is a Modbus master device, substitute “master” for “client” and “slave” for “server.”

Connection example

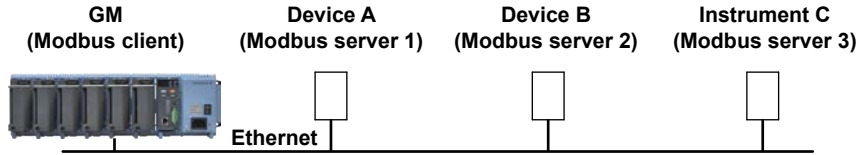

Loading into Communication Channels

The GM enters data loaded from the server into communication channels as floating point type data.

Example 1

Load the 16-bit signed integer value assigned to register 30001 of instrument A to C001.

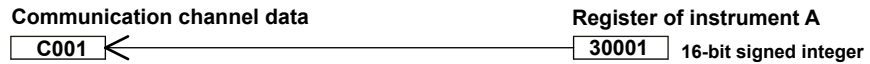

Command setting

Setup Item	Value	
Client command number	1	
Command setting	Type	Read
	Server	1
	Data type	INT16
	Register	30001
	Channel type	Communication channel
	First-CH	C001
	Last-CH	C001

Example 2

Load the 32-bit signed integer value assigned to registers 30003 and 30004 (little endian) of instrument B to C003. Only the smallest register number need be specified in commands.

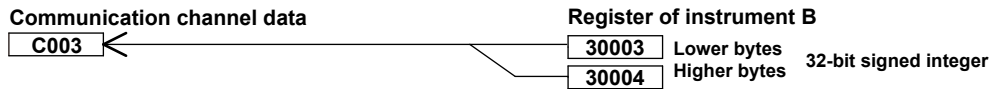

Command setting

Setup Item	Value	
Client command number	2	
Command setting	Type	Read
	Server	2
	Data type	INT32 L
	Register	30003
	Channel type	Communication channel
	First-CH	C003
	Last-CH	C003

Example 3

Load the 16-bit signed integer values assigned to registers 30001 and 30002 of instrument B to C001 and C002. Only the smallest register number need be specified in commands.

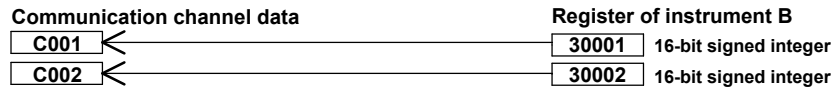

Command setting

Setup Item	Value
Client command number	3
Command setting	Type Read
	Server 2
	Data type INT16
	Register 30001
	Channel type Communication channel
	First-CH C001
	Last-CH C002

Example 4

Load the 32-bit floating point values assigned to registers 30005 and 30006 (little endian) of instrument B to C004. Only the smallest register number need be specified in commands.

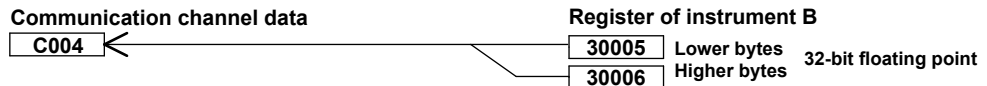

Command setting

Setup Item	Value
Client command number	4
Command setting	Type Read
	Server 2
	Data type FLOAT L
	Register 30005
	Channel type Communication channel
	First-CH C004
	Last-CH C004

Writing Data to a Server

Example

Write the measured value from I/O channel 0001 to register 40001 of instrument A.



Command setting

Setup Item	Value
Client command number	5
Command setting	Type Write
	Server 1
	Data type INT16
	Register 40001
	Channel type I/O channel
	First-CH 0001
	Last-CH 0001

Writing Computed Values to a Server

Example

Write the computed values from channel A001 to registers 40001 and 40002 of instrument A, in the order lower 16 bits/higher 16 bits. Only the smallest register number need be specified in commands.

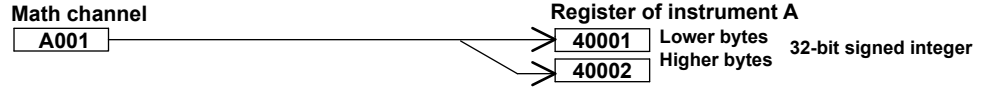

Command setting

Setup Item	Value
Client command number	6
Command setting	Type Write
	Server 1
	Data type INT32 L
	Register 40001
	Channel type Math channel
	First-CH A001
	Last-CH A001

4.2.5 Checking the Modbus Operation Status

Procedure

- ▶ For the procedure, see “Checking the Command Status of the Modbus Client and Modbus Master” on page 3-34.

4.3 Using Modbus to Enable Other Devices to Read Data from and Write Data to the GM (Modbus slave function)

The GM can operate as a Modbus slave device.

Other devices (Modbus master devices) can carry out the following operations on the GM.

- Read I/O channel and math channel (/MT option) data (input register)
- Read communication channel (/MC option) data (hold register)
- Write communication channel (/MC option) data (hold register)
- Start and stop recording, write messages, and perform other operations (using the hold register)
- Load the recording start/stop condition, message strings, and other types of data (using the hold register)

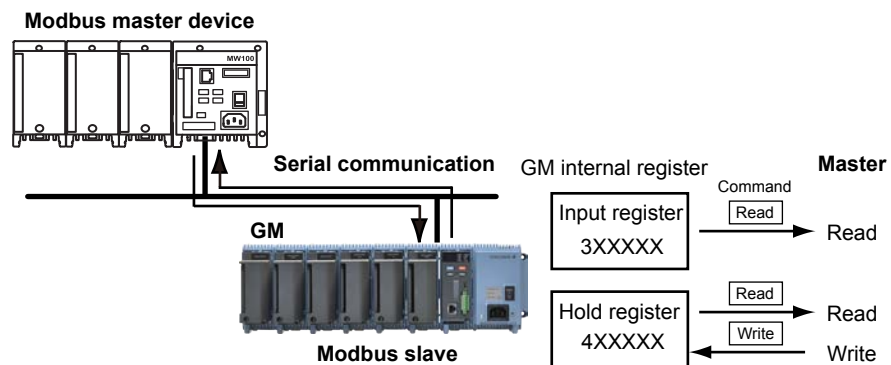

4.3.1 Setting Serial Communication Conditions

Description

- **Configure the receiver function**
 - **Set data transfer conditions**
- For details on the settings, see page 2-172 in section 2.23.1, “Setting Basic Communication Conditions”.

4.3.2 Reading from and Writing to the GM from Other Devices

Other devices (master devices) can transmit commands to the GM to read data from and write data to the GM. By writing data to the GM internal registers, you can control the GM (such as start recording).

- For details on the function codes that the GM supports and the GM registers that master devices can access, see page 4-10 in section 4.5, “Modbus Function and Register Assignments”.

4.4 Using Modbus to Enable the GM to Read Data from and Write Data to Other Devices (Modbus master function)

The GM can operate as a Modbus master device.

The GM can connect to another device (Modbus slave device) via Modbus and read from and write to the device's internal registers. Read data can be handled using communication channels. Data that can be written are I/O channel data, math channel data, and communication channel data.

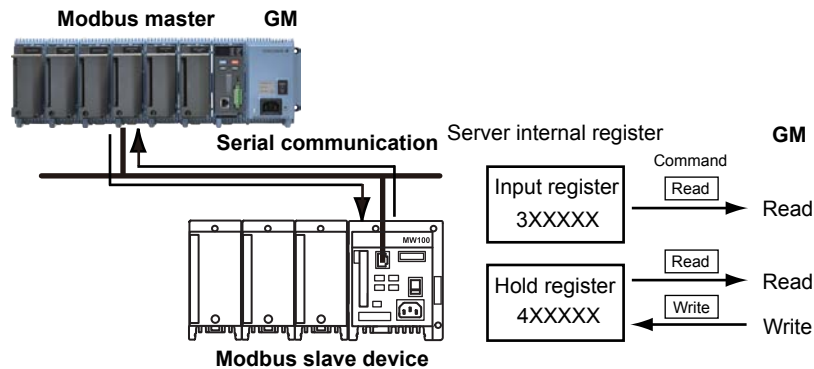

4.4.1 Setting Serial Communication Conditions

Description

- **Configure the receiver function**
 - **Set data transfer conditions**
- ▶ For details on the settings, see page 2-172 in section 2.23.1, “Setting Basic Communication Conditions”.

4.4.2 Configuring the Modbus Master Function

Description

- **Enable the master function**
 - **Set communication conditions**
 - **Set the recovery action**
- ▶ For details on the settings, see page 2-174 in section 2.23.2, “Enabling or Disabling the Modbus Master Function (/MC option) and Setting Communication Conditions”.
- ▶ For details on the Modbus functions and registers that the GM supports, see page 4-10 in section 4.5, “Modbus Function and Register Assignments”.

4.4.3 Setting Commands

Description

- **Set the master command number**
 - **Set the command**
- ▶ For details on the settings, see page 2-175 in section 2.23.3, “Setting Modbus Master Transmission Commands”.
- ▶ For command setting examples, see page 4-4 in section 4.2.4, “Setting Commands”.

4.5 Modbus Function and Register Assignments

4.5.1 Modbus Client/Master Function

Function

The GM supports the following functions.

The server (slave) must support these functions.

Function Code	Function	Operation
1	Read the coil status (0xxxx)	The GM reads the coil status of the server (slave) device.
2	Read the input relay status (1xxxx, 1xxxx)	The GM reads the input relay status of the server (slave) device.
3	Read the hold register (4XXXX, 4XXXX)	The GM reads the hold register of the server (slave) into a communication channel.
4	Read the input register (3XXXX, 3XXXX)	The GM reads the input register of the server (slave) into a communication channel.
5	Change the single coil status (0xxxx)	The GM changes the single coil status of the server (slave) device (off/on).
6	Write to a single hold register (4xxxx, 4xxxx)	The GM writes to a single hold register of the server (slave).
15	Change the coil status (0xxxx)	The GM changes the coil status of the server (slave) device (off/on).
16	Write to the hold register (4XXXX, 4XXXX)	The GM writes the I/O channel data, math channel data, or communication channel data to the hold register of the server (slave).

Command

Command type: Read, Write

Number of commands: GM10-1: Set up to 100 commands.

GM10-2: Set up to 200 commands.

Data type: See the table below.

Symbol	Description
INT16	16-bit signed integer
UINT16	16-bit unsigned integer
INT32_B	32-bit signed integer (big endian)
INT32_L	32-bit signed integer (little endian)
UINT32_B	32-bit unsigned integer (big endian)
UINT32_L	32-bit unsigned integer (little endian)
FLOAT_B	32-bit floating point (big endian)
FLOAT_L	32-bit floating point (little endian)
BIT	Bit

Special Value Output

When a register is read or when its content is exported through the Modbus function, the GM may output the following special values.

Channel status	Data type	
	Integer	Floating
+Over, +Burnout	Maximum expressible value	+∞
-Over, -Burnout	Minimum expressible value	-∞

Example: Channel status is “-Over”

Data type	Output value
Int16	-32768 (0x8000)
Int32	-2147483648 (0x80000000)
Float	-∞ (0xff800000)

Loading into Communication Channels

- Read values from the server (slave) register into the communication channels of the GM.
- The communication channel function is an option (/MC).

GM		Server (slave)	
Command Type	Channel type: Comm. channel Number: C001 to C300 (GM10-1) C001 to C500 (GM10-2) Type: INT 16, UINT 16, INT 32_B, INT 32_L, UINT 32_B, UINT 32_L, FLOAT_B, FLOAT_L, BIT	Register	Data Type
Read		1 to 9999 10001 to 19999 100001 to 165535 30001 to 39999 300001 to 365535 40001 to 49999 400001 to 465535	INT 16, UINT 16, INT 32_B, INT 32_L, UINT 32_B, UINT 32_L, FLOAT_B, FLOAT_L, BIT

← Read

Writing I/O Channel Data

- Write I/O channel data to the server (slave) registers.

GM		Server (slave)	
Command Type	Channel type: I/O channel Number: 0001 to 6550 Type: INT 16, UINT 16, INT 32_B, INT 32_L, UINT 32_B, UINT 32_L, FLOAT_B, FLOAT_L, BIT	Register	Data Type
Write		1 to 9999 40001 to 49999 400001 to 465535	INT 16, UINT 16, INT 32_B, INT 32_L, UINT 32_B, UINT 32_L, FLOAT_B, FLOAT_L, BIT

→ Write

Writing Math Channel Data

- The math function is an option (/MT).
- Write math channel data to the server (slave) registers.

GM		Server (slave)	
Command Type	Channel type: Math channel Number: A001 to A100 (GM10-1) A001 to A200 (GM10-2) Type: INT 16, UINT 16, INT 32_B, INT 32_L, UINT 32_B, UINT 32_L, FLOAT_B, FLOAT_L, BIT	Register	Data Type
Write		1 to 9999 40001 to 49999 400001 to 465535	INT 16, UINT 16, INT 32_B, INT 32_L, UINT 32_B, UINT 32_L, FLOAT_B, FLOAT_L, BIT

→ Write

Writing Communication Channel Data

- Write GM communication channel data to the server (slave) registers.

GM		Server (slave)	
Command Type	Data type: Comm channel data Number: C001 to C300 (GM10-1) C001 to C500 (GM10-2) Type: INT 16, UINT 16, INT 32_B, INT 32_L, UINT 32_B, UINT 32_L, FLOAT_B, FLOAT_L, BIT	Register	Data Type
Write		1 to 9999 40001 to 49999 400001 to 465535	INT 16, UINT 16, INT 32_B, INT 32_L, UINT 32_B, UINT 32_L, FLOAT_B, FLOAT_L, BIT

→ Write

4.5.2 Modbus Server/Slave Function

Function

The GM supports the following functions.

Function Code	Function	Operation
1	Read the coil status (0xxxx)	The client (master) device reads the coil status of the GM.
2	Read the input relay status (1xxxx, 1xxxxx)	The client (master) device reads the input relay status of the GM.
3	Read the hold register (4XXXX, 4XXXXX)	The client (master) device reads the GM data.
4	Read the input register (3XXXX, 3XXXXX)	The client (master) device reads the I/O, math, alarm, time data from the GM.
5	Change the single coil status (0xxxx)	The client (master) device changes the single coil status (off/on) of the GM.
6	Write to a single hold register (4xxxx, 4xxxx)	The client (master) device writes to a single hold register of the GM.
8*	Loop-back test	The master device performs a GM loopback test.
15	Change the coil status (0xxxx)	The client (master) device changes the coil status (off/on) of the GM.
16	Write to the hold register (4XXXX, 4XXXXX)	The client (master) device writes to the GM communication channels.

* Loopback test is only for serial communication.

4.5.3 Register Assignments (Shared with the Modbus server/slave function)

Input register

Unit	Type		GM Register		
			Number	Data Type	
Main unit	I/O channel	I/O data	300001 to 301000	32-bit signed integer	
			301001 to 302000	32-bit floating point	
			302001 to 302500	16-bit signed integer	
	I/O channel (continuous area)	I/O data	Status information	302501 to 303000	16-bit signed integer
			304001 to 304200	304201 to 304400	32-bit signed integer
				304401 to 304500	32-bit floating point
	Math channel (A001 to A100)	Math data	Status information	304501 to 304600	16-bit signed integer
			305001 to 305200	305201 to 305400	32-bit signed integer
				305401 to 305500	32-bit floating point
	Math channel (A101 to A200)	Math data	Status information	305501 to 305600	16-bit signed integer
			306001 to 306200	306201 to 306400	32-bit signed integer
				306401 to 306500	32-bit floating point
	GM status	Status information	306501 to 306600	16-bit signed integer	
			308001 to 308022	16-bit signed integer	
			308101 to 308182	16-bit signed integer	
	Latest health score results status		308301 to 308334	16-bit signed integer	

Continued on next page

Unit	Type		GM Register	
			Number	Data Type
Sub unit	Unit 1 I/O channel	I/O data	310001 to 311000	32-bit signed integer
			311001 to 312000	32-bit floating point
		Status information	312001 to 312500	16-bit signed integer
			312501 to 313000	16-bit signed integer
	Unit 2 I/O channel	I/O data	315001 to 316000	32-bit signed integer
			316001 to 317000	32-bit floating point
		Status information	317001 to 317500	16-bit signed integer
			317501 to 318000	16-bit signed integer
	Unit 3 I/O channel	I/O data	320001 to 321000	32-bit signed integer
			321001 to 322000	32-bit floating point
		Status information	322001 to 322500	16-bit signed integer
			322501 to 323500	16-bit signed integer
Unit 4 I/O channel	I/O data	325001 to 326000	32-bit signed integer	
		326001 to 327000	32-bit floating point	
	Status information	327001 to 327500	16-bit signed integer	
		327501 to 328000	16-bit signed integer	
Sub unit	Unit 5 I/O channel	I/O data	330001 to 331000	32-bit signed integer
			331001 to 332000	32-bit floating point
		Status information	332001 to 332500	16-bit signed integer
			332500 to 333000	16-bit signed integer
	Unit 6 I/O channel	I/O data	335001 to 336000	32-bit signed integer
			336001 to 337000	32-bit floating point
		Status information	337001 to 337500	16-bit signed integer
			337501 to 338000	16-bit signed integer

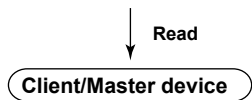

Hold register

Unit	Type		GM Register	
			Number	Data Type
Main unit	I/O channel	I/O data	400001 to 401000	32-bit signed integer
			401001 to 402000	32-bit floating point
		402001 to 402500	16-bit signed integer	
		Status information	402501 to 403000	16-bit signed integer
	I/O channel (continuous area)	I/O data	404001 to 404200	32-bit signed integer
			404201 to 404400	32-bit floating point
		404401 to 404500	16-bit signed integer	
		Status information	404501 to 404600	16-bit signed integer
	Communication channel	Communication data	405001 to 406000	32-bit signed integer
			406001 to 407000	32-bit floating point
		407001 to 407500	16-bit signed integer	
	Status information	407501 to 408000	16-bit signed integer	
Internal switch		408001 to 408100	16-bit signed integer	
GM operation setting		409001 to 410000	16-bit signed integer	
Sub unit	Unit 1 I/O channel	I/O data	410001 to 411000	32-bit signed integer
			411001 to 412000	32-bit floating point
		412001 to 412500	16-bit signed integer	
		Status information	412501 to 413000	16-bit signed integer
	Unit 2 I/O channel	I/O data	415001 to 416000	32-bit signed integer
			416001 to 417000	32-bit floating point
		417001 to 417500	16-bit signed integer	
		Status information	417501 to 418000	16-bit signed integer
	Unit 3 I/O channel	I/O data	420001 to 421000	32-bit signed integer
			421001 to 422000	32-bit floating point
		422001 to 422500	16-bit signed integer	
		Status information	422501 to 423000	16-bit signed integer
	Unit 4 I/O channel	I/O data	425001 to 426000	32-bit signed integer
			426001 to 427000	32-bit floating point
		427001 to 427500	16-bit signed integer	
		Status information	427501 to 428000	16-bit signed integer
	Unit 5 I/O channel	I/O data	430001 to 431000	32-bit signed integer
			431001 to 432000	32-bit floating point
		432001 to 432500	16-bit signed integer	
		Status information	432501 to 433000	16-bit signed integer
	Unit 6 I/O channel	I/O data	435001 to 436000	32-bit signed integer
			436001 to 437000	32-bit floating point
		437001 to 437500	16-bit signed integer	
		I/O data	437501 to 438000	16-bit signed integer
Channel properties	Channel information	Channel properties	440001 to 465000	16-bit signed integer



Coil

Only channels on the main unit can be accessed. Channel information in each register corresponds to a channel in order from the first specified register. With I/O channels, 50 registers are assigned per module.

Type		GM Register	
		Number	Data Type
I/O channel	I/O data	00001 to 00500	Bit string
	Status information	00501 to 01000	
Communication channel	Communication data	001001 to 01500	
	Status information	01501 to 02000	
Internal switch		02001 to 02100	



Input Relay

Only channels on the main unit can be accessed. Channel information in each register corresponds to a channel in order from the first specified register. With I/O channels, 50 registers are assigned per module.

Type		GM Register	
		Number	Data Type
I/O channel	I/O data	100001 to 100500	Bit string
	Status information	100501 to 101000	
Math channel	Math data	101001 to 101100	
	Status information	101501 to 101600	



4.5.4 Input Registers (Shared with the Modbus server/slave function)

Common Items

- The client (master) device can only read the input registers.
- Decimal place and unit are not included. Specify them on the client (master) device.
- Due to the different number of channels between modules, unavailable channel numbers will exist. This will not cause a register read error, so you can read the data continuously.
- The register values for unavailable channel numbers are set to 0, and the status information is set to SKIP.
- Channel range

Channel type	GM10	GM10-2
I/O channel	0001 to 6950	0001 to 6950
Math channel	A001 to A100	A001 to A200

- If Log scale calculation (/LG option) is performed on an AI channel, data of I/O channels set to 32-bit signed integer or 16-bit signed integer will be an integer with two- or three-digit mantissa.

I/O Channel Data

- **32-bit signed integer**

Unit	I/O channel data	Input register	Data type
Main unit	Lower bytes of the channel 0001 data	300001	32-bit signed integer
	Higher bytes of the channel 0001 data	300002	
	Lower bytes of the channel 0050 data	300099	
	Higher bytes of the channel 0050 data	300100	
	Lower bytes of the channel 0101 data	300101	
	Higher bytes of the channel 0101 data	300102	
	Lower bytes of the channel 0150 data	300199	
	Higher bytes of the channel 0150 data	300200	
	Lower bytes of the channel 0201 data	300201	
	Higher bytes of the channel 0201 data	300202	
	Lower bytes of the channel 0250 data	300299	
	Higher bytes of the channel 0250 data	300300	
	Lower bytes of the channel 0301 data	300301	
	Higher bytes of the channel 0301 data	300302	
	Lower bytes of the channel 0350 data	300399	
	Higher bytes of the channel 0350 data	300400	
	Lower bytes of the channel 0401 data	300401	
	Higher bytes of the channel 0401 data	300402	
	Lower bytes of the channel 0450 data	300499	
	Higher bytes of the channel 0450 data	300500	
	Lower bytes of the channel 0501 data	300501	
	Higher bytes of the channel 0501 data	300502	
Lower bytes of the channel 0550 data	300599		
Higher bytes of the channel 0550 data	300600		
Lower bytes of the channel 0601 data	300601		
Higher bytes of the channel 0601 data	300602		
Lower bytes of the channel 0650 data	300699		
Higher bytes of the channel 0650 data	300700		

Continued on next page

Unit	I/O channel data	Input register	Data type	
Main unit	Lower bytes of the channel 0701 data	300701	32-bit signed integer	
	Higher bytes of the channel 0701 data	300702		
	Lower bytes of the channel 0750 data	300799		
	Higher bytes of the channel 0750 data	300800		
	Lower bytes of the channel 0801 data	300801		
	Higher bytes of the channel 0801 data	300802		
	Lower bytes of the channel 0850 data	300899		
	Higher bytes of the channel 0850 data	300900		
	Lower bytes of the channel 0901 data	300901		
	Higher bytes of the channel 0901 data	300902		
	Lower bytes of the channel 0950 data	300999		
	Higher bytes of the channel 0950 data	301000		
	Sub unit 1	Lower bytes of the channel 1001 data	310001	
		Higher bytes of the channel 1001 data	310002	
Lower bytes of the channel 1050 data		310099		
Higher bytes of the channel 1050 data		310100		
Lower bytes of the channel 1101 data		310101		
Higher bytes of the channel 1101 data		310102		
Lower bytes of the channel 1150 data		310199		
Higher bytes of the channel 1150 data		310200		
Lower bytes of the channel 1201 data		310201		
Higher bytes of the channel 1201 data		310202		
Lower bytes of the channel 1250 data		310299		
Higher bytes of the channel 1250 data		310300		
Lower bytes of the channel 1301 data		310301		
Higher bytes of the channel 1301 data		310302		
Lower bytes of the channel 1350 data		310399		
Higher bytes of the channel 1350 data		310400		
Lower bytes of the channel 1401 data		310401		
Higher bytes of the channel 1401 data		310402		
Lower bytes of the channel 1450 data		310499		
Higher bytes of the channel 1450 data		310500		
Lower bytes of the channel 1501 data		310501		
Higher bytes of the channel 1501 data		310502		
Lower bytes of the channel 1550 data		310599		
Higher bytes of the channel 1550 data		310600		
Sub unit 2	Lower bytes of the channel 2001 data	315001		
	Higher bytes of the channel 2001 data	315002		
	Lower bytes of the channel 2050 data	315099		
	Higher bytes of the channel 2050 data	315100		
	Lower bytes of the channel 2101 data	315101		
Higher bytes of the channel 2101 data	315102			
Lower bytes of the channel 2150 data	315199			
Higher bytes of the channel 2150 data	315200			

Continued on next page

4.5 Modbus Function and Register Assignments

Unit	I/O channel data	Input register	Data type
Sub unit 2	Lower bytes of the channel 2201 data	315201	32-bit signed integer
	Higher bytes of the channel 2201 data	315202	
	Lower bytes of the channel 2250 data	315299	
	Higher bytes of the channel 2250 data	315300	
	Lower bytes of the channel 2301 data	315301	
	Higher bytes of the channel 2301 data	315302	
	Lower bytes of the channel 2350 data	315399	
	Higher bytes of the channel 2350 data	315400	
	Lower bytes of the channel 2401 data	315401	
	Higher bytes of the channel 2401 data	315402	
	Lower bytes of the channel 2450 data	315499	
	Higher bytes of the channel 2450 data	315500	
	Lower bytes of the channel 2501 data	315501	
	Higher bytes of the channel 2501 data	315502	
	Lower bytes of the channel 2550 data	315599	
	Higher bytes of the channel 2550 data	315600	
Sub unit 3	Lower bytes of the channel 3001 data	320001	
	Higher bytes of the channel 3001 data	320002	
	Lower bytes of the channel 3050 data	320099	
	Higher bytes of the channel 3050 data	320100	
	Lower bytes of the channel 3101 data	320101	
	Higher bytes of the channel 3101 data	320102	
	Lower bytes of the channel 3150 data	320199	
	Higher bytes of the channel 3150 data	320200	
	Lower bytes of the channel 3201 data	320201	
	Higher bytes of the channel 3201 data	320202	
	Lower bytes of the channel 3250 data	320299	
	Higher bytes of the channel 3250 data	320300	
	Lower bytes of the channel 3301 data	320301	
	Higher bytes of the channel 3301 data	320302	
	Lower bytes of the channel 3350 data	320399	
	Higher bytes of the channel 3350 data	320400	
Lower bytes of the channel 3401 data	320401		
Higher bytes of the channel 3401 data	320402		
Lower bytes of the channel 3450 data	320499		
Higher bytes of the channel 3450 data	320500		
Lower bytes of the channel 3501 data	320501		
Higher bytes of the channel 3501 data	320502		
Lower bytes of the channel 3550 data	320599		
Higher bytes of the channel 3550 data	320600		
Sub unit 4	Lower bytes of the channel 4001 data	325001	
	Higher bytes of the channel 4001 data	325002	
	Lower bytes of the channel 4050 data	325099	
Higher bytes of the channel 4050 data	325100		

Continued on next page

Unit	I/O channel data	Input register	Data type	
Sub unit 4	Lower bytes of the channel 4101 data	325101	32-bit signed integer	
	Higher bytes of the channel 4101 data	325102		
	Lower bytes of the channel 4150 data	325199		
	Higher bytes of the channel 4150 data	325200		
	Lower bytes of the channel 4201 data	325201		
	Higher bytes of the channel 4201 data	325202		
	Lower bytes of the channel 4250 data	325299		
	Higher bytes of the channel 4250 data	325300		
	Lower bytes of the channel 4301 data	325301		
	Higher bytes of the channel 4301 data	325302		
	Lower bytes of the channel 4350 data	325399		
	Higher bytes of the channel 4350 data	325400		
	Lower bytes of the channel 4401 data	325401		
	Higher bytes of the channel 4401 data	325402		
	Lower bytes of the channel 4450 data	325499		
	Higher bytes of the channel 4450 data	325500		
	Lower bytes of the channel 4501 data	325201		
	Higher bytes of the channel 4501 data	325502		
	Lower bytes of the channel 4550 data	325599		
	Higher bytes of the channel 4550 data	325600		
	Sub unit 5	Lower bytes of the channel 5001 data		330001
		Higher bytes of the channel 5001 data		330002
Lower bytes of the channel 5050 data		330099		
Higher bytes of the channel 5050 data		330100		
Lower bytes of the channel 5101 data		330101		
Higher bytes of the channel 5101 data		330102		
Lower bytes of the channel 5150 data		330199		
Higher bytes of the channel 5150 data		330200		
Lower bytes of the channel 5201 data		330201		
Higher bytes of the channel 5201 data		330202		
Lower bytes of the channel 5250 data		330299		
Higher bytes of the channel 5250 data		330300		
Lower bytes of the channel 5301 data		330301		
Higher bytes of the channel 5301 data		330302		
Lower bytes of the channel 5350 data		330399		
Higher bytes of the channel 5350 data		330400		
Lower bytes of the channel 5401 data		330401		
Higher bytes of the channel 5401 data		330402		
Lower bytes of the channel 5450 data		330499		
Higher bytes of the channel 5450 data		330500		
Lower bytes of the channel 5501 data		330501		
Higher bytes of the channel 5501 data		330502		
Lower bytes of the channel 5550 data	330599			
Higher bytes of the channel 5550 data	330600			

Continued on next page

4.5 Modbus Function and Register Assignments

Unit	I/O channel data	Input register	Data type
Sub unit 6	Lower bytes of the channel 6001 data	335001	32-bit signed integer
	Higher bytes of the channel 6001 data	335002	
	Lower bytes of the channel 6050 data	335099	
	Higher bytes of the channel 6050 data	335100	
	Lower bytes of the channel 6101 data	335101	
	Higher bytes of the channel 6101 data	335102	
	Lower bytes of the channel 6150 data	335199	
	Higher bytes of the channel 6150 data	335200	
	Lower bytes of the channel 6201 data	335201	
	Higher bytes of the channel 6201 data	335202	
	Lower bytes of the channel 6250 data	335299	
	Higher bytes of the channel 6250 data	335300	
	Lower bytes of the channel 6301 data	335301	
	Higher bytes of the channel 6301 data	335302	
	Lower bytes of the channel 6350 data	335399	
	Higher bytes of the channel 6350 data	335400	
	Lower bytes of the channel 6401 data	335401	
	Higher bytes of the channel 6401 data	335402	
	Lower bytes of the channel 6450 data	335499	
	Higher bytes of the channel 6450 data	335500	
	Lower bytes of the channel 6501 data	335501	
	Higher bytes of the channel 6501 data	335502	
	Lower bytes of the channel 6550 data	335599	
	Higher bytes of the channel 6550 data	335600	

• Register

Channel 0001 example

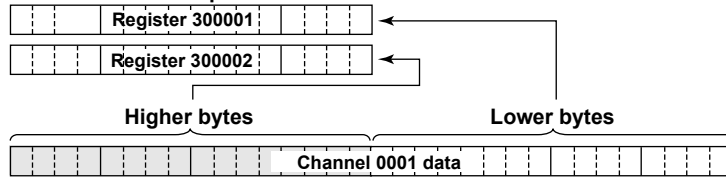

• There is no decimal place information.

- **32-bit floating point**

Unit	I/O channel data	Input register	Data type
Main unit	Lower bytes of the channel 0001 data	301001	32-bit floating point
	Higher bytes of the channel 0001 data	301002	
	Lower bytes of the channel 0050 data	301099	
	Higher bytes of the channel 0050 data	301100	
	Lower bytes of the channel 0101 data	301101	
	Higher bytes of the channel 0101 data	301102	
	Lower bytes of the channel 0150 data	301199	
	Higher bytes of the channel 0150 data	301200	
	Lower bytes of the channel 0201 data	301201	
	Higher bytes of the channel 0201 data	301202	
	Lower bytes of the channel 0250 data	301299	
	Higher bytes of the channel 0250 data	301300	
	Lower bytes of the channel 0301 data	301301	
	Higher bytes of the channel 0301 data	301302	
	Lower bytes of the channel 0350 data	301399	
	Higher bytes of the channel 0350 data	301400	
	Lower bytes of the channel 0401 data	301401	
	Higher bytes of the channel 0401 data	301402	
	Lower bytes of the channel 0450 data	301499	
	Higher bytes of the channel 0450 data	301500	
	Lower bytes of the channel 0501 data	301501	
	Higher bytes of the channel 0501 data	301502	
	Lower bytes of the channel 0550 data	301599	
	Higher bytes of the channel 0550 data	301600	
	Lower bytes of the channel 0601 data	301601	
	Higher bytes of the channel 0601 data	301602	
	Lower bytes of the channel 0650 data	301699	
	Higher bytes of the channel 0650 data	301700	
	Lower bytes of the channel 0701 data	301701	
	Higher bytes of the channel 0701 data	301702	
	Lower bytes of the channel 0750 data	301799	
	Higher bytes of the channel 0750 data	301800	
Lower bytes of the channel 0801 data	301801		
Higher bytes of the channel 0801 data	301802		
Lower bytes of the channel 0850 data	301899		
Higher bytes of the channel 0850 data	301900		
Lower bytes of the channel 0901 data	301901		
Higher bytes of the channel 0901 data	301902		
Lower bytes of the channel 0950 data	301999		
Higher bytes of the channel 0950 data	302000		

Continued on next page

4.5 Modbus Function and Register Assignments

Unit	I/O channel data	Input register	Data type
Sub unit 1	Lower bytes of the channel 1001 data	311001	32-bit floating point
	Higher bytes of the channel 1001 data	311002	
	Lower bytes of the channel 1050 data	311099	
	Higher bytes of the channel 1050 data	311100	
	Lower bytes of the channel 1101 data	311101	
	Higher bytes of the channel 1101 data	311102	
	Lower bytes of the channel 1150 data	311199	
	Higher bytes of the channel 1150 data	311200	
	Lower bytes of the channel 1201 data	311201	
	Higher bytes of the channel 1201 data	311202	
	Lower bytes of the channel 1250 data	311299	
	Higher bytes of the channel 1250 data	311300	
	Lower bytes of the channel 1301 data	311301	
	Higher bytes of the channel 1301 data	311302	
	Lower bytes of the channel 1350 data	311399	
	Higher bytes of the channel 1350 data	311400	
	Lower bytes of the channel 1401 data	311401	
	Higher bytes of the channel 1401 data	311402	
	Lower bytes of the channel 1450 data	311499	
	Higher bytes of the channel 1450 data	311500	
	Lower bytes of the channel 1501 data	311501	
	Higher bytes of the channel 1501 data	311502	
Lower bytes of the channel 1550 data	311599		
Higher bytes of the channel 1550 data	311600		
Sub unit 2	Lower bytes of the channel 2001 data	316001	
	Higher bytes of the channel 2001 data	316002	
	Lower bytes of the channel 2050 data	316099	
	Higher bytes of the channel 2050 data	316100	
	Lower bytes of the channel 2101 data	316101	
	Higher bytes of the channel 2101 data	316102	
	Lower bytes of the channel 2150 data	316199	
	Higher bytes of the channel 2150 data	316200	
	Lower bytes of the channel 2201 data	316201	
	Higher bytes of the channel 2201 data	316202	
	Lower bytes of the channel 2250 data	316299	
	Higher bytes of the channel 2250 data	316300	
	Lower bytes of the channel 2301 data	316301	
	Higher bytes of the channel 2301 data	316302	
Lower bytes of the channel 2350 data	316399		
Higher bytes of the channel 2350 data	316400		
Lower bytes of the channel 2401 data	316401		
Higher bytes of the channel 2401 data	316402		
Lower bytes of the channel 2450 data	316499		
Higher bytes of the channel 2450 data	316500		
Lower bytes of the channel 2501 data	316501		
Higher bytes of the channel 2501 data	316502		
Lower bytes of the channel 2550 data	316599		
Higher bytes of the channel 2550 data	316600		

Continued on next page

Unit	I/O channel data	Input register	Data type
Sub unit 3	Lower bytes of the channel 3001 data	321001	32-bit floating point
	Higher bytes of the channel 3001 data	321002	
	Lower bytes of the channel 3050 data	321099	
	Higher bytes of the channel 3050 data	321100	
	Lower bytes of the channel 3101 data	321101	
	Higher bytes of the channel 3101 data	321102	
	Lower bytes of the channel 3150 data	321199	
	Higher bytes of the channel 3150 data	321200	
	Lower bytes of the channel 3201 data	321201	
	Higher bytes of the channel 3201 data	321202	
	Lower bytes of the channel 3250 data	321299	
	Higher bytes of the channel 3250 data	321300	
	Lower bytes of the channel 3301 data	321301	
	Higher bytes of the channel 3301 data	321302	
	Lower bytes of the channel 3350 data	321399	
	Higher bytes of the channel 3350 data	321400	
	Lower bytes of the channel 3401 data	321401	
	Higher bytes of the channel 3401 data	321402	
	Lower bytes of the channel 3450 data	321499	
	Higher bytes of the channel 3450 data	321500	
	Lower bytes of the channel 3501 data	321501	
	Higher bytes of the channel 3501 data	321502	
Lower bytes of the channel 3550 data	321599		
Higher bytes of the channel 3550 data	321600		
Sub unit 4	Lower bytes of the channel 4001 data	326001	
	Higher bytes of the channel 4001 data	326002	
	Lower bytes of the channel 4050 data	326099	
	Higher bytes of the channel 4050 data	326100	
	Lower bytes of the channel 4101 data	326101	
	Higher bytes of the channel 4101 data	326102	
	Lower bytes of the channel 4150 data	326199	
	Higher bytes of the channel 4150 data	326200	
	Lower bytes of the channel 4201 data	326201	
	Higher bytes of the channel 4201 data	326202	
	Lower bytes of the channel 4250 data	326299	
	Higher bytes of the channel 4250 data	326300	
	Lower bytes of the channel 4301 data	326301	
	Higher bytes of the channel 4301 data	326302	
	Lower bytes of the channel 4350 data	326399	
	Higher bytes of the channel 4350 data	326400	
	Lower bytes of the channel 4401 data	326401	
	Higher bytes of the channel 4401 data	326402	
	Lower bytes of the channel 4450 data	326499	
	Higher bytes of the channel 4450 data	326500	
	Lower bytes of the channel 4501 data	326501	
	Higher bytes of the channel 4501 data	326502	
Lower bytes of the channel 4550 data	326599		
Higher bytes of the channel 4550 data	326600		

Continued on next page

4.5 Modbus Function and Register Assignments

Unit	I/O channel data	Input register	Data type
Sub unit 5	Lower bytes of the channel 5001 data	331001	32-bit floating point
	Higher bytes of the channel 5001 data	331002	
	Lower bytes of the channel 5050 data	331099	
	Higher bytes of the channel 5050 data	331100	
	Lower bytes of the channel 5101 data	331101	
	Higher bytes of the channel 5101 data	331102	
	Lower bytes of the channel 5150 data	331199	
	Higher bytes of the channel 5150 data	331200	
	Lower bytes of the channel 5201 data	331201	
	Higher bytes of the channel 5201 data	331202	
	Lower bytes of the channel 5250 data	331299	
	Higher bytes of the channel 5250 data	331300	
	Lower bytes of the channel 5301 data	331301	
	Higher bytes of the channel 5301 data	331302	
	Lower bytes of the channel 5350 data	331399	
	Higher bytes of the channel 5350 data	331400	
	Lower bytes of the channel 5401 data	331401	
	Higher bytes of the channel 5401 data	331402	
	Lower bytes of the channel 5450 data	331499	
	Higher bytes of the channel 5450 data	331500	
	Lower bytes of the channel 5501 data	331501	
	Higher bytes of the channel 5501 data	331502	
Lower bytes of the channel 5550 data	331599		
Higher bytes of the channel 5550 data	331600		
Sub unit 6	Lower bytes of the channel 6001 data	336001	
	Higher bytes of the channel 6001 data	336002	
	Lower bytes of the channel 6050 data	336099	
	Higher bytes of the channel 6050 data	336100	
	Lower bytes of the channel 6101 data	336101	
	Higher bytes of the channel 6101 data	336102	
	Lower bytes of the channel 6150 data	336199	
	Higher bytes of the channel 6150 data	336200	
	Lower bytes of the channel 6201 data	336201	
	Higher bytes of the channel 6201 data	336202	
	Lower bytes of the channel 6250 data	336299	
	Higher bytes of the channel 6250 data	336300	
	Lower bytes of the channel 6301 data	336301	
	Higher bytes of the channel 6301 data	336302	
	Lower bytes of the channel 6350 data	336399	
	Higher bytes of the channel 6350 data	336400	
	Lower bytes of the channel 6401 data	336401	
	Higher bytes of the channel 6401 data	336402	
	Lower bytes of the channel 6450 data	336499	
	Higher bytes of the channel 6450 data	336500	
	Lower bytes of the channel 6501 data	336501	
	Higher bytes of the channel 6501 data	336502	
Lower bytes of the channel 6550 data	336599		
Higher bytes of the channel 6550 data	336600		

- 16-bit signed integer

Unit	I/O channel data	Input register	Data type
Main unit	Channel 0001 data	302001	16-bit signed integer
	Channel 0050 data	302050	
	Channel 0101 data	302051	
	Channel 0150 data	302100	
	Channel 0201 data	302101	
	Channel 0250 data	302150	
	Channel 0301 data	302151	
	Channel 0350 data	302200	
	Channel 0401 data	302201	
	Channel 0450 data	302250	
	Channel 0501 data	302251	
	Channel 0550 data	302300	
	Channel 0601 data	302301	
Channel 0650 data	302350		
Channel 0701 data	302351		
Channel 0750 data	302400		
Channel 0801 data	302401		
Channel 0850 data	302450		
Channel 0901 data	302451		
Channel 0950 data	302500		
Sub unit 1	Channel 1001 data	312001	
Channel 1050 data	312050		
Channel 1101 data	312051		
Channel 1150 data	312100		
Channel 1201 data	312101		
Channel 1250 data	312150		
Channel 1301 data	312151		
Channel 1350 data	312200		
Channel 1401 data	312201		
Channel 1450 data	312250		
Channel 1501 data	312251		
Channel 1550 data	312300		
Sub unit 2	Channel 2001 data	317001	
Channel 2050 data	317050		
Channel 2101 data	317051		
Channel 2150 data	317100		
Channel 2201 data	317101		
Channel 2250 data	317150		

Continued on next page

4.5 Modbus Function and Register Assignments

Unit	I/O channel data	Input register	Data type
Sub unit 2	Channel 2301 data	317151	16-bit signed integer
	Channel 2350 data	317200	
	Channel 2401 data	317201	
	Channel 2450 data	317250	
	Channel 2501 data	317251	
	Channel 2550 data	317300	
Sub unit 3	Channel 3001 data	322001	
	Channel 3050 data	322050	
	Channel 3101 data	322051	
	Channel 3150 data	322100	
	Channel 3201 data	322101	
	Channel 3250 data	322150	
	Channel 3301 data	322151	
	Channel 3350 data	322200	
	Channel 3401 data	322201	
	Channel 3450 data	322250	
	Channel 3501 data	322251	
	Channel 3550 data	322300	
	Sub unit 4	Channel 4001 data	327001
		Channel 4050 data	327050
Channel 4101 data		327051	
Channel 4150 data		327100	
Channel 4201 data		327101	
Channel 4250 data		327150	
Channel 4301 data		327151	
Channel 4350 data		327200	
Channel 4401 data		327201	
Channel 4450 data		327250	
Channel 4501 data		327251	
Channel 4550 data		327300	
Sub unit 5		Channel 5001 data	332001
		Channel 5050 data	332050
	Channel 5101 data	332051	
	Channel 5150 data	332100	
	Channel 5201 data	332101	
	Channel 5250 data	332150	
	Channel 5301 data	332151	
	Channel 5350 data	332200	
	Channel 5401 data	332201	
	Channel 5450 data	332250	

Continued on next page

Unit	I/O channel data	Input register	Data type
Sub unit 5	Channel 5501 data	332251	16-bit signed integer
	Channel 5550 data	332300	
Sub unit 6	Channel 6001 data	337001	
	Channel 6050 data	337050	
	Channel 6101 data	337051	
	Channel 6150 data	337100	
	Channel 6201 data	337101	
	Channel 6250 data	337150	
	Channel 6301 data	337151	
	Channel 6350 data	337200	
	Channel 6401 data	337201	
	Channel 6450 data	337250	
	Channel 6501 data	337251	
	Channel 6550 data	337300	

I/O Channel Data Status Information

Unit	I/O channel data	Input register	Data type
Main unit	Channel 0001 status information	302501	16-bit signed integer
	Channel 0050 status information	302550	
	Channel 0101 status information	302551	
	Channel 0150 status information	302600	
	Channel 0201 status information	302601	
	Channel 0250 status information	302650	
	Channel 0301 status information	302651	
	Channel 0350 status information	302700	
	Channel 0401 status information	302701	
	Channel 0450 status information	302750	
	Channel 0501 status information	302751	
	Channel 0550 status information	302800	
	Channel 0601 status information	302801	
Channel 0650 status information	302850		
Channel 0701 status information	302851		
Channel 0750 status information	302900		
Channel 0801 status information	302901		
Channel 0850 status information	302950		
Channel 0901 status information	302951		
Channel 0950 status information	303000		
Sub unit 1	Channel 1001 status information	312501	
	Channel 1050 status information	312550	
	Channel 1101 status information	312551	
	Channel 1150 status information	312600	
	Channel 1201 status information	312601	
	Channel 1250 status information	312650	
	Channel 1301 status information	312651	
	Channel 1350 status information	312700	
Channel 1401 status information	312701		
Channel 1450 status information	312750		
Channel 1501 status information	312751		
Channel 1550 status information	312800		

Continued on next page

Unit	I/O channel data	Input register	Data type
Sub unit 2	Channel 2001 status information	317501	16-bit signed integer
	Channel 2050 status information	317550	
	Channel 2101 status information	317551	
	Channel 2150 status information	317600	
	Channel 2201 status information	317601	
	Channel 2250 status information	317650	
	Channel 2301 status information	317651	
	Channel 2350 status information	317700	
	Channel 2401 status information	317701	
	Channel 2450 status information	317750	
Channel 2501 status information	317751		
Sub unit 3	Channel 2550 status information	317800	
	Channel 3001 status information	322501	
	Channel 3050 status information	322550	
	Channel 3101 status information	322551	
	Channel 3150 status information	322600	
	Channel 3201 status information	322601	
	Channel 3250 status information	322650	
	Channel 3301 status information	322651	
	Channel 3350 status information	322700	
	Channel 3401 status information	322701	
Channel 3450 status information	322750		
Channel 3501 status information	322751		
Sub unit 4	Channel 3550 status information	322800	
	Channel 4001 status information	327501	
	Channel 4050 status information	327550	
	Channel 4101 status information	327551	
	Channel 4150 status information	327600	
	Channel 4201 status information	327601	
	Channel 4250 status information	327650	
	Channel 4301 status information	327651	
	Channel 4350 status information	327700	
	Channel 4401 status information	327701	
Channel 4450 status information	327750		
Channel 4501 status information	327751		
Sub unit 4	Channel 4550 status information	327800	

Continued on next page

4.5 Modbus Function and Register Assignments

Unit	I/O channel data	Input register	Data type	
Sub unit 5	Channel 5001 status information	332501	16-bit signed integer	
	Channel 5050 status information	332550		
	Channel 5101 status information	332551		
	Channel 5150 status information	332600		
	Channel 5201 status information	332601		
	Channel 5250 status information	332650		
	Channel 5301 status information	332651		
	Channel 5350 status information	332700		
	Channel 5401 status information	332701		
	Channel 5450 status information	332750		
	Channel 5501 status information	332751		
	Channel 5550 status information	332800		
	Sub unit 6	Channel 6001 status information		337501
		Channel 6050 status information		337550
		Channel 6101 status information		337551
Channel 6150 status information		337600		
Channel 6201 status information		337601		
Channel 6250 status information		337650		
Channel 6301 status information		337651		
Channel 6350 status information		337700		
Channel 6401 status information		337701		
Channel 6450 status information		337750		
Channel 6501 status information		337751		
Channel 6550 status information		337800		

- There is no decimal place information.

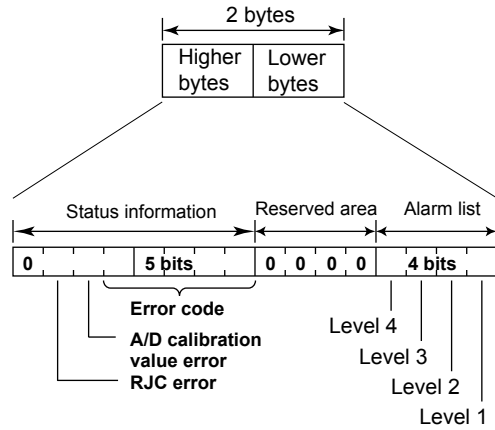

Error code	Meaning
0	No error
1	Skip
2	+Over
3	-Over
4	+Burnout
5	-Burnout
6	A/D error
7	Invalid data
16	Computation error
17	Communication error

Register Configuration of PID Control Module Channels

The following table shows the register configuration when a PID control module is installed in unit 0 (main unit) slot 0.

* If the PID module is installed in unit 1 slot 3, channel numbers 1301 to 1350 will be allocated.

Channel number	Description	Notes
0001	PV of loop 1	PID computation data
0002	SP of loop 1	
0003	OUT of loop 1	
0004	PV of loop 2	
0005	SP of loop 2	
0006	OUT of loop 2	
0007	Input 1 data	Physical channel data
0008	Input 2 data	
0009	Output 1 data	
0010	Output 2 data	
0011	DI1 data	
0012	DI2 data	
0013	DI3 data	
0014	DI4 data	
0015	DI5 data	
0016	DI6 data	
0017	DI7 data	
0018	DI8 data	
0019	DO1 data	
0020	DO2 data	
0021	DO3 data	
0022	DO4 data	
0023	DO5 data	
0024	DO6 data	
0025	DO7 data	
0026	DO8 data	
0027		
0034		
0035	Alarms 1 to 4 of loop 1	Lower 4 bits
0036	Alarms 1 to 4 of loop 2	Lower 4 bits
0037	Auto/manual/cascade switching of loop 1	1: Auto 2: Manual 3: Cascade
0038	Auto/manual/cascade switching of loop 2	1: Auto 2: Manual 3: Cascade
0039	Run/stop switching of loop 1	1: Run 2: Stop
0040	Run/stop switching of loop 2	1: Run 2: Stop
0041	Remote/local switching of loop 1	1: Local 2: Remote
0042	Remote/local switching of loop 2	1: Local 2: Remote
0043	Target setpoint number (SP number) selection of loop 1	1 to 8
0044	Target setpoint number (SP number) selection of loop 2	1 to 8
0045	PID number selection of loop 1	Read only
0046	PID number selection of loop 2	Read only
0047	Auto-tuning status of loop 1	Read only
0048	Auto-tuning status of loop 2	Read only
0049	Alarm ACK of loop 1	1: Alarm ACK 0 when read
0050		1: Alarm ACK 0 when read

PID Control Module Status Information

The following status information of each module loop is output to channels 35 to 50.

Item	Description
Control alarm information	Alarms 1 to 4 (lower 4 bits)
Auto/manual/cascade switching	1: Auto, 2: Manual, 3: Cascade
Run/stop status	1: Run, 2: Stop
Remote/local switching	1: Local, 2: Remote
Target setpoint number (SP number) selection	1 to 8
PID number selection	1 to 8, 9 for the reference PID
Auto-tuning status	1 to 8 for when auto-tuning is in progress 9 for the reference PID 0 when stopped
Alarm ACK	1: Alarm ACK, 0 when read

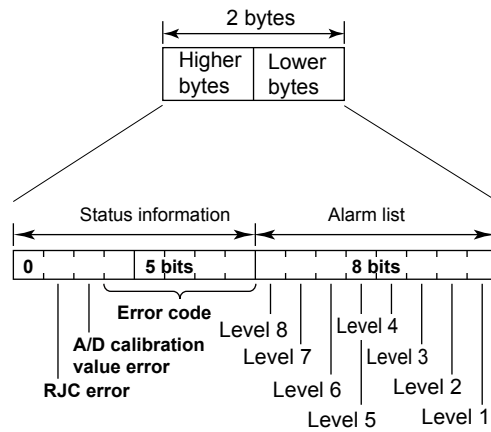

Error code	Meaning
0	No error
1	Skip
2	+Over
3	-Over
4	+Burnout
5	-Burnout
6	A/D error
7	Invalid data
16	Computation error
17	Communication error

Math Channel Data and Status Information

Data	Register	Data Type
Lower bytes of the computed data of channel A001	305001	32-bit signed integer
Higher bytes of the computed data of channel A001	305002	
Lower bytes of the computed data of channel A100	305199	32-bit signed integer
Higher bytes of the computed data of channel A100	305200	
Lower bytes of the computed data of channel A101	306001	32-bit signed integer
Higher bytes of the computed data of channel A101	306002	
Lower bytes of the computed data of channel A200	306199	32-bit signed integer
Higher bytes of the computed data of channel A200	306200	

• Register configuration of computed data

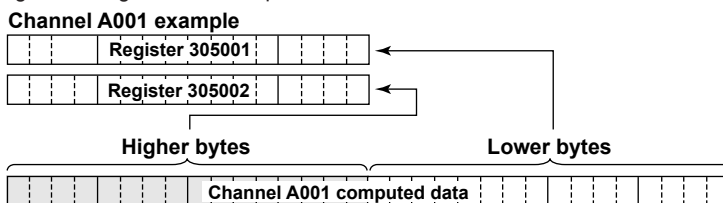

• There is no decimal place information.

Lower bytes of the computed data of channel A001	305201	32-bit floating point
Higher bytes of the computed data of channel A001	305202	
Lower bytes of the computed data of channel A100	305399	32-bit floating point
Higher bytes of the computed data of channel A100	305400	
Lower bytes of the computed data of channel A101	306201	32-bit floating point
Higher bytes of the computed data of channel A101	306202	
Lower bytes of the computed data of channel A200	306399	32-bit floating point
Higher bytes of the computed data of channel A200	306400	

• There is no decimal place information.

Channel A001 computed data	305401	16-bit signed integer
Channel A100 computed data	305500	
Channel A101 computed data	306401	
Channel A200 computed data	306500	

• There is no decimal place information.

Channel A001 status information	305501	16-bit signed integer
Channel A100 status information	305600	
Channel A101 computed data	306501	
Channel A200 computed data	306600	

• Status register configuration

This is the same as that of the I/O channel data status information.

Continuous Channel Data Area

The GM reserves up to 50 channels of register area per module. For example, reading 100 channels of data from 10 analog input modules through normal input registers would be inefficient because there would be a lot of empty registers. The “continuous channel data area” is a special area that enables continuous reading by limiting the number of channels of each module to 10. It is for I/O channels installed in the GM main unit.

I/O Channel Data

- **32-bit signed integer**

I/O channel data	Input register	Data Type
Lower bytes of the channel 0001 data	304001	32-bit signed integer
Higher bytes of the channel 0001 data	304002	
Lower bytes of the channel 0010 data	304019	
Higher bytes of the channel 0010 data	304020	
Lower bytes of the channel 0101 data	304021	
Higher bytes of the channel 0101 data	304022	
Lower bytes of the channel 0110 data	304039	
Higher bytes of the channel 0110 data	304040	
Lower bytes of the channel 0201 data	304041	
Higher bytes of the channel 0201 data	304042	
Lower bytes of the channel 0210 data	304059	
Higher bytes of the channel 0210 data	304060	
Lower bytes of the channel 0301 data	304061	
Higher bytes of the channel 0301 data	304062	
Lower bytes of the channel 0310 data	304079	
Higher bytes of the channel 0310 data	304080	
Lower bytes of the channel 0401 data	304081	
Higher bytes of the channel 0401 data	304082	
Lower bytes of the channel 0410 data	304099	
Higher bytes of the channel 0410 data	304100	
Lower bytes of the channel 0501 data	304101	
Higher bytes of the channel 0501 data	304102	
Lower bytes of the channel 0510 data	304119	
Higher bytes of the channel 0510 data	304120	
Lower bytes of the channel 0601 data	304121	
Higher bytes of the channel 0601 data	304122	
Lower bytes of the channel 0610 data	304139	
Higher bytes of the channel 0610 data	304140	
Lower bytes of the channel 0701 data	304141	
Higher bytes of the channel 0701 data	304142	
Lower bytes of the channel 0710 data	304159	
Higher bytes of the channel 0710 data	304160	
Lower bytes of the channel 0801 data	304161	
Higher bytes of the channel 0801 data	304162	
Lower bytes of the channel 0810 data	304179	
Higher bytes of the channel 0810 data	304180	
Lower bytes of the channel 0901 data	304181	
Higher bytes of the channel 0901 data	304182	
Lower bytes of the channel 0910 data	304199	
Higher bytes of the channel 0910 data	304200	

Continued on next page

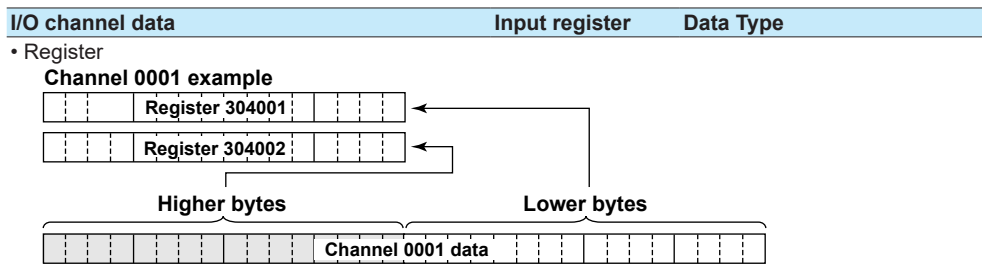

• There is no decimal place information.

• **32-bit floating point**

I/O channel data	Input register	Data Type
Lower bytes of the channel 0001 data	304201	32-bit floating point
Higher bytes of the channel 0001 data	304202	
Lower bytes of the channel 0010 data	304219	
Higher bytes of the channel 0010 data	304220	
Lower bytes of the channel 0101 data	304221	
Higher bytes of the channel 0101 data	304222	
Lower bytes of the channel 0110 data	304239	
Higher bytes of the channel 0110 data	304240	
Lower bytes of the channel 0201 data	304241	
Higher bytes of the channel 0201 data	304242	
Lower bytes of the channel 0210 data	304259	
Higher bytes of the channel 0210 data	304260	
Lower bytes of the channel 0301 data	304261	
Higher bytes of the channel 0301 data	304262	
Lower bytes of the channel 0310 data	304279	
Higher bytes of the channel 0310 data	304280	
Lower bytes of the channel 0401 data	304281	
Higher bytes of the channel 0401 data	304282	
Lower bytes of the channel 0410 data	304299	
Higher bytes of the channel 0410 data	304300	
Lower bytes of the channel 0501 data	304301	
Higher bytes of the channel 0501 data	304302	
Lower bytes of the channel 0510 data	304319	
Higher bytes of the channel 0510 data	304320	
Lower bytes of the channel 0601 data	304321	
Higher bytes of the channel 0601 data	304322	
Lower bytes of the channel 0610 data	304339	
Higher bytes of the channel 0610 data	304340	
Lower bytes of the channel 0701 data	304341	
Higher bytes of the channel 0701 data	304342	
Lower bytes of the channel 0710 data	304359	
Higher bytes of the channel 0710 data	304360	
Lower bytes of the channel 0801 data	304361	
Higher bytes of the channel 0801 data	304362	
Lower bytes of the channel 0810 data	304379	
Higher bytes of the channel 0810 data	304380	
Lower bytes of the channel 0901 data	304381	32-bit floating point
Higher bytes of the channel 0901 data	304382	
Lower bytes of the channel 0910 data	304399	
Higher bytes of the channel 0910 data	304400	

• **16-bit signed integer**

I/O channel data	Input register	Data Type
Channel 0001 data	304401	16-bit signed integer
Channel 0010 data	304410	
Channel 0101 data	304411	
Channel 0110 data	304420	
Channel 0201 data	304421	
Channel 0210 data	304430	
Channel 0301 data	304431	
Channel 0310 data	304440	
Channel 0401 data	304441	
Channel 0410 data	304450	
Channel 0501 data	304451	
Channel 0510 data	304460	
Channel 0601 data	304461	
Channel 0610 data	304470	
Channel 0701 data	304471	
Channel 0710 data	304480	
Channel 0801 data	304481	
Channel 0810 data	304490	
Channel 0901 data	304491	
Channel 0910 data	304500	

I/O Channel Data Status Information

I/O channel data	Input register	Data Type
Channel 0001 status information	304501	16-bit signed integer
Channel 0010 status information	304510	
Channel 0101 status information	304511	
Channel 0110 status information	304520	
Channel 0201 status information	304521	
Channel 0210 status information	304530	
Channel 0301 status information	304531	
Channel 0310 status information	304540	
Channel 0401 status information	304541	
Channel 0410 status information	304550	
Channel 0501 status information	304551	
Channel 0510 status information	304560	
Channel 0601 status information	304561	16-bit signed integer
Channel 0610 status information	304570	
Channel 0701 status information	304571	
Channel 0710 status information	304580	
Channel 0801 status information	304581	
Channel 0810 status information	304590	
Channel 0901 status information	304591	
Channel 0910 status information	304600	

Continued on next page

I/O channel data	Input register	Data Type
------------------	----------------	-----------

• There is no decimal place information.

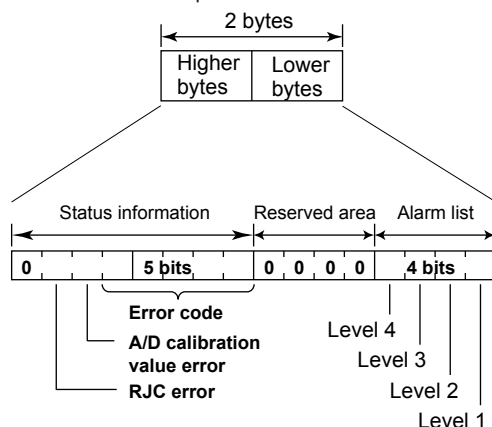

Error code	Meaning
0	No error
1	Skip
2	+Over
3	-Over
4	+Burnout
5	-Burnout
6	A/D error
7	Invalid data
16	Computation error
17	Communication error

GM status

Data	Register	Description	Data Type
Measuring	308001	0: Recording stopped 1: Recording	16-bit signed integer
Computing	308002	0: Computing stopped 1: Computing	
Alarm activated	308003	0: No alarm 1: Alarm occurrence	
E-mail started	308004	0: No e-mail transmission 1: E-mail transmission available	
Memory end	308005	0: Space available in the internal memory or external storage 1: Not much space in the internal memory or external storage	
Screen login status	308006	0: No login 1: Logged in	
Modbus communication error	308007	0: Modbus master or client command normal 1: Modbus master or client command error	
User locked status (only for the advanced security function (IAS option))	308008	0: User unlocked status 1: User locked status	
Multi batch 1 measuring	308011	0: Stop recording 1: Recording	
Multi batch 12 measuring	308022		

Program operation status

Data	Register	Description	Data Type
Program operation status	308101	0: Stop 1: Running	16-bit signed integer
Running pattern number display	308102	1 to 99: Pattern number	
Running segment number display	308103	0: Program operation stop 1 to 99: Segment number	
Wait state	308104	0: Not waiting 1: Waiting	
Remaining segment time of the running pattern (hours)	308105	0 to 99: Hours	
Remaining segment time of the running pattern (minutes)	308106	0 to 59: Minutes	
Remaining segment time of the running pattern (seconds)	308107	0 to 59: Seconds	
PV event status	308111 308142	0: Event absent 1: Event present	
Time event status	308151 208182	0: Event absent 1: Event present	

Latest health score results status

Data	Register	Description	Data Type
Batch judgment start time	308301	0 to 65535: Year	16-bit signed integer
	308302	1 to 12: Month	
	308303	1 to 31: Day	
	308304	0 to 23: Hour	
	308305	0 to 59: Minute	
	308306	0 to 59: Second	
Batch judgment end time	308307	0 to 65535: Year	
	308308	1 to 12: Month	
	308309	1 to 31: Day	
	308310	0 to 23: Hour	
	308311	0 to 59: Minute	
	308312	0 to 59: Second	
Early notification status	308313	0: There is no log or the Early Notification function is OFF. 1: Equal to or above the threshold 2: Below the threshold	
Judgment results	308314	0: Default value 1: OK 2: NG ("NG" means Not Good.)	
Health score	308314 308315	Float-L type	32-bit floating point
Predictive detection model file name	308317 308334	UTF-8 string, maximum 32 bytes, ends in a NULL character	16-bit signed integer

- Read only. Not writable.
- If the Health Monitor function is OFF or there is no Health Monitor log, all registers return an initial value of "0".
- If the Early Notification function is OFF, the Early Notification status returns an initial value of "0".

4.5.5 Hold Registers (Shared with the Modbus server/slave function)

Common Items

- The client (master) device can read and write to the hold registers.
- Communication channels are an option (/MC).
- Channel range by model

Channel type	GM10-1	GM10-2
I/O channel	0001 to 6950	0001 to 6950
Communication channel	C001 to C300	C001 to C500

- Math channels are input registers only.
- If Log scale calculation (/LG option) is performed on an AI channel, data of I/O channels set to 32-bit signed integer or 16-bit signed integer will be an integer with two- or three-digit mantissa.

I/O Channel Data*

- 32-bit signed integer

Unit	I/O channel data	Hold register	Data Type
Main unit	Lower bytes of the channel 0001 data	400001	32-bit signed integer
	Higher bytes of the channel 0001 data	400002	
	Lower bytes of the channel 0050 data	400099	
	Higher bytes of the channel 0050 data	400100	
	Lower bytes of the channel 0101 data	400101	
	Higher bytes of the channel 0101 data	400102	
	Lower bytes of the channel 0150 data	400199	
	Higher bytes of the channel 0150 data	400200	
	Lower bytes of the channel 0201 data	400201	
	Higher bytes of the channel 0201 data	400202	
	Lower bytes of the channel 0250 data	400299	
	Higher bytes of the channel 0250 data	400300	
	Lower bytes of the channel 0301 data	400301	
	Higher bytes of the channel 0301 data	400302	
	Lower bytes of the channel 0350 data	400399	
	Higher bytes of the channel 0350 data	400400	
	Lower bytes of the channel 0401 data	400401	
	Higher bytes of the channel 0401 data	400402	
	Lower bytes of the channel 0450 data	400499	
	Higher bytes of the channel 0450 data	400500	
	Lower bytes of the channel 0501 data	400501	
	Higher bytes of the channel 0501 data	400502	
	Lower bytes of the channel 0550 data	400599	
	Higher bytes of the channel 0550 data	400600	
	Lower bytes of the channel 0601 data	400601	
	Higher bytes of the channel 0601 data	400602	
	Lower bytes of the channel 0650 data	400699	
	Higher bytes of the channel 0650 data	400700	
	Lower bytes of the channel 0701 data	400701	
	Higher bytes of the channel 0701 data	400702	
	Lower bytes of the channel 0750 data	400799	
	Higher bytes of the channel 0750 data	400800	

Continued on next page

4.5 Modbus Function and Register Assignments

Unit	I/O channel data	Input register	Data Type
Main unit	Lower bytes of the channel 0801 data	400801	32-bit signed integer
	Higher bytes of the channel 0801 data	400802	
	Lower bytes of the channel 0850 data	400899	
	Higher bytes of the channel 0850 data	400900	
	Lower bytes of the channel 0901 data	400901	
	Higher bytes of the channel 0901 data	400902	
	Lower bytes of the channel 0950 data	400999	
	Higher bytes of the channel 0950 data	401000	
Sub unit 1	Lower bytes of the channel 1001 data	410001	
	Higher bytes of the channel 1001 data	410002	
	Lower bytes of the channel 1050 data	410099	
	Higher bytes of the channel 1050 data	410100	
	Lower bytes of the channel 1101 data	410101	
	Higher bytes of the channel 1101 data	410102	
	Lower bytes of the channel 1150 data	410199	
	Higher bytes of the channel 1150 data	410200	
	Lower bytes of the channel 1201 data	410201	
	Higher bytes of the channel 1201 data	410202	
	Lower bytes of the channel 1250 data	410299	
	Higher bytes of the channel 1250 data	410300	
	Lower bytes of the channel 1301 data	410301	
	Higher bytes of the channel 1301 data	410302	
	Lower bytes of the channel 1350 data	410399	
	Higher bytes of the channel 1350 data	410400	
	Lower bytes of the channel 1401 data	410401	
	Higher bytes of the channel 1401 data	410402	
	Lower bytes of the channel 1450 data	410499	
	Higher bytes of the channel 1450 data	410500	
	Lower bytes of the channel 1501 data	410501	
	Higher bytes of the channel 1501 data	410502	
	Lower bytes of the channel 1550 data	410599	
	Higher bytes of the channel 1550 data	410600	
Sub unit 2	Lower bytes of the channel 2001 data	415001	
	Higher bytes of the channel 2001 data	415002	
	Lower bytes of the channel 2050 data	415099	
	Higher bytes of the channel 2050 data	415100	
	Lower bytes of the channel 2101 data	415101	
	Higher bytes of the channel 2101 data	415102	
	Lower bytes of the channel 2150 data	415199	
	Higher bytes of the channel 2150 data	415200	
	Lower bytes of the channel 2201 data	415201	
	Higher bytes of the channel 2201 data	415202	
	Lower bytes of the channel 2250 data	415299	
Higher bytes of the channel 2250 data	415300		
Lower bytes of the channel 2301 data	415301		
Higher bytes of the channel 2301 data	415302		
Lower bytes of the channel 2350 data	415399		
Higher bytes of the channel 2350 data	415400		

Continued on next page

Unit	I/O channel data	Input register	Data Type	
Sub unit 2	Lower bytes of the channel 2401 data	415401	32-bit signed integer	
	Higher bytes of the channel 2401 data	415402		
	Lower bytes of the channel 2450 data	415499		
	Higher bytes of the channel 2450 data	415500		
	Lower bytes of the channel 2501 data	415501		
	Higher bytes of the channel 2501 data	415502		
	Lower bytes of the channel 2550 data	415599		
	Higher bytes of the channel 2550 data	415600		
	Sub unit 3	Lower bytes of the channel 3001 data	420001	
		Higher bytes of the channel 3001 data	420002	
Lower bytes of the channel 3050 data		420099		
Higher bytes of the channel 3050 data		420100		
Lower bytes of the channel 3101 data		420101		
Higher bytes of the channel 3101 data		420102		
Lower bytes of the channel 3150 data		420199		
Higher bytes of the channel 3150 data		420200		
Lower bytes of the channel 3201 data		420201		
Higher bytes of the channel 3201 data		420202		
Lower bytes of the channel 3250 data		420299		
Higher bytes of the channel 3250 data		420300		
Lower bytes of the channel 3301 data		420301		
Higher bytes of the channel 3301 data		420302		
Lower bytes of the channel 3350 data		420399		
Higher bytes of the channel 3350 data		420400		
Lower bytes of the channel 3401 data		420401		
Higher bytes of the channel 3401 data		420402		
Lower bytes of the channel 3450 data		420499		
Higher bytes of the channel 3450 data		420500		
Lower bytes of the channel 3501 data		420501		
Higher bytes of the channel 3501 data		420502		
Lower bytes of the channel 3550 data		420599		
Higher bytes of the channel 3550 data		420600		
Sub unit 4		Lower bytes of the channel 4001 data	425001	
		Higher bytes of the channel 4001 data	425002	
		Lower bytes of the channel 4050 data	425099	
		Higher bytes of the channel 4050 data	425100	
		Lower bytes of the channel 4101 data	425101	
	Higher bytes of the channel 4101 data	425102		
	Lower bytes of the channel 4150 data	425199		
	Higher bytes of the channel 4150 data	425200		
	Lower bytes of the channel 4201 data	425201		
	Higher bytes of the channel 4201 data	425202		
	Lower bytes of the channel 4250 data	425299		
	Higher bytes of the channel 4250 data	425300		
	Lower bytes of the channel 4301 data	425301		
	Higher bytes of the channel 4301 data	425302		
Lower bytes of the channel 4350 data	425399			
Higher bytes of the channel 4350 data	425400			

Continued on next page

4.5 Modbus Function and Register Assignments

Unit	I/O channel data	Input register	Data Type
Sub unit 4	Lower bytes of the channel 4401 data	425401	32-bit signed integer
	Higher bytes of the channel 4401 data	425402	
	Lower bytes of the channel 4450 data	425499	
	Higher bytes of the channel 4450 data	425500	
	Lower bytes of the channel 4501 data	425501	
	Higher bytes of the channel 4501 data	425502	
	Lower bytes of the channel 4550 data	425599	
	Higher bytes of the channel 4550 data	425600	
Sub unit 5	Lower bytes of the channel 5001 data	430001	
	Higher bytes of the channel 5001 data	430002	
	Lower bytes of the channel 5050 data	430099	
	Higher bytes of the channel 5050 data	430100	
	Lower bytes of the channel 5101 data	430101	
	Higher bytes of the channel 5101 data	430102	
	Lower bytes of the channel 5150 data	430199	
	Higher bytes of the channel 5150 data	430200	
	Lower bytes of the channel 5201 data	430201	
	Higher bytes of the channel 5201 data	430202	
	Lower bytes of the channel 5250 data	430299	
	Higher bytes of the channel 5250 data	430300	
	Lower bytes of the channel 5301 data	430301	
	Higher bytes of the channel 5301 data	430302	
	Lower bytes of the channel 5350 data	430399	
	Higher bytes of the channel 5350 data	430400	
	Lower bytes of the channel 5401 data	430401	
	Higher bytes of the channel 5401 data	430402	
	Lower bytes of the channel 5450 data	430499	
	Higher bytes of the channel 5450 data	430500	
	Lower bytes of the channel 5501 data	430501	
	Higher bytes of the channel 5501 data	430502	
	Lower bytes of the channel 5550 data	430599	
	Higher bytes of the channel 5550 data	430600	
Sub unit 6	Lower bytes of the channel 6001 data	435001	
	Higher bytes of the channel 6001 data	435002	
	Lower bytes of the channel 6050 data	435099	
	Higher bytes of the channel 6050 data	435100	
	Lower bytes of the channel 6101 data	435101	
	Higher bytes of the channel 6101 data	435102	
	Lower bytes of the channel 6150 data	435199	
	Higher bytes of the channel 6150 data	435200	
	Lower bytes of the channel 6201 data	435201	
	Higher bytes of the channel 6201 data	435202	
	Lower bytes of the channel 6250 data	435299	
Higher bytes of the channel 6250 data	435300		
Lower bytes of the channel 6301 data	435301		
Higher bytes of the channel 6301 data	435302		
Lower bytes of the channel 6350 data	435399		
Higher bytes of the channel 6350 data	435400		

Continued on next page

Unit	I/O channel data	Input register	Data Type
Sub unit 6	Lower bytes of the channel 6401 data	435401	32-bit signed integer
	Higher bytes of the channel 6401 data	435402	
	Lower bytes of the channel 6450 data	435499	
	Higher bytes of the channel 6450 data	435500	
	Lower bytes of the channel 6501 data	435501	
	Higher bytes of the channel 6501 data	435502	
	Lower bytes of the channel 6550 data	435599	
	Higher bytes of the channel 6550 data	435600	

• Register

Channel 0001 example

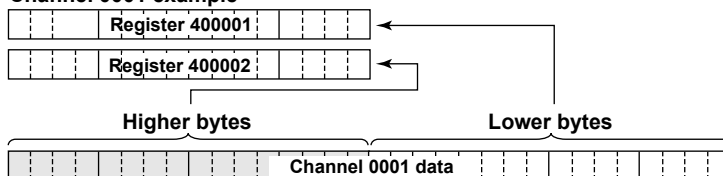

• There is no decimal place information.

- * When Modbus writing is performed on a channel of a DO module, a relay output occurs from the corresponding channel of the DO module.
Write a 0 to turn the relay off
Write a nonzero value to turn the relay on
To enable relay output from a DO module through Modbus writing, the DO channel range type must be set to **Manual**.
▶ See page 2-63 in section 2.7.1, "Setting the Range".

• **32-bit floating point**

Unit	I/O channel data	Hold register	Data Type
Main unit	Lower bytes of the channel 0001 data	401001	32-bit floating point
	Higher bytes of the channel 0001 data	401002	
	Lower bytes of the channel 0050 data	401099	
	Higher bytes of the channel 0050 data	401100	
	Lower bytes of the channel 0101 data	401101	
	Higher bytes of the channel 0101 data	401102	
	Lower bytes of the channel 0150 data	401199	
	Higher bytes of the channel 0150 data	401200	
	Lower bytes of the channel 0201 data	401201	
	Higher bytes of the channel 0201 data	401202	
	Lower bytes of the channel 0250 data	401299	
	Higher bytes of the channel 0250 data	401300	
	Lower bytes of the channel 0301 data	401301	
	Higher bytes of the channel 0301 data	401302	
	Lower bytes of the channel 0350 data	401399	
	Higher bytes of the channel 0350 data	401400	
	Lower bytes of the channel 0401 data	401401	
	Higher bytes of the channel 0401 data	401402	
	Lower bytes of the channel 0450 data	401499	
	Higher bytes of the channel 0450 data	401500	
	Lower bytes of the channel 0501 data	401501	
	Higher bytes of the channel 0501 data	401502	
	Lower bytes of the channel 0550 data	401599	
	Higher bytes of the channel 0550 data	401600	
	Lower bytes of the channel 0601 data	401601	
	Higher bytes of the channel 0601 data	401602	
	Lower bytes of the channel 0650 data	401699	
	Higher bytes of the channel 0650 data	401700	
	Lower bytes of the channel 0701 data	401701	
	Higher bytes of the channel 0701 data	401702	
	Lower bytes of the channel 0750 data	401799	
	Higher bytes of the channel 0750 data	401800	
Lower bytes of the channel 0801 data	401801		
Higher bytes of the channel 0801 data	401802		
Lower bytes of the channel 0850 data	401899		
Higher bytes of the channel 0850 data	401900		
Lower bytes of the channel 0901 data	401901		
Higher bytes of the channel 0901 data	401902		
Lower bytes of the channel 0950 data	401999		
Higher bytes of the channel 0950 data	402000		

Continued on next page

Unit	I/O channel data	Hold register	Data Type
Sub unit 1	Lower bytes of the channel 1001 data	411001	32-bit floating point
	Higher bytes of the channel 1001 data	411002	
	Lower bytes of the channel 1050 data	411099	
	Higher bytes of the channel 1050 data	411100	
	Lower bytes of the channel 1101 data	411101	
	Higher bytes of the channel 1101 data	411102	
	Lower bytes of the channel 1150 data	411199	
	Higher bytes of the channel 1150 data	411200	
	Lower bytes of the channel 1201 data	411201	
	Higher bytes of the channel 1201 data	411202	
	Lower bytes of the channel 1250 data	411299	
	Higher bytes of the channel 1250 data	411300	
	Lower bytes of the channel 1301 data	411301	
	Higher bytes of the channel 1301 data	411302	
	Lower bytes of the channel 1350 data	411399	
	Higher bytes of the channel 1350 data	411400	
	Lower bytes of the channel 1401 data	411401	
	Higher bytes of the channel 1401 data	411402	
	Lower bytes of the channel 1450 data	411499	
	Higher bytes of the channel 1450 data	411500	
	Lower bytes of the channel 1501 data	411501	
	Higher bytes of the channel 1501 data	411502	
Lower bytes of the channel 1550 data	411599		
Higher bytes of the channel 1550 data	411600		
Sub unit 2	Lower bytes of the channel 2001 data	416001	
	Higher bytes of the channel 2001 data	416002	
	Lower bytes of the channel 2050 data	416099	
	Higher bytes of the channel 2050 data	416100	
	Lower bytes of the channel 2101 data	416101	
	Higher bytes of the channel 2101 data	416102	
	Lower bytes of the channel 2150 data	416199	
	Higher bytes of the channel 2150 data	416200	
	Lower bytes of the channel 2201 data	416201	
	Higher bytes of the channel 2201 data	416202	
	Lower bytes of the channel 2250 data	416299	
	Higher bytes of the channel 2250 data	416300	
	Lower bytes of the channel 2301 data	416301	
	Higher bytes of the channel 2301 data	416302	
	Higher bytes of the channel 2350 data	416399	
	Higher bytes of the channel 2350 data	416400	
	Lower bytes of the channel 2401 data	416401	
	Higher bytes of the channel 2401 data	416402	
	Higher bytes of the channel 2450 data	416499	
Higher bytes of the channel 2450 data	416500		
Lower bytes of the channel 2501 data	416501		
Higher bytes of the channel 2501 data	416502		
Higher bytes of the channel 2550 data	416599		
Higher bytes of the channel 2550 data	416600		

Continued on next page

4.5 Modbus Function and Register Assignments

Unit	I/O channel data	Hold register	Data Type	
Sub unit 3	Lower bytes of the channel 3001 data	421001	32-bit floating point	
	Higher bytes of the channel 3001 data	421002		
	Lower bytes of the channel 3050 data	421099		
	Higher bytes of the channel 3050 data	421100		
	Lower bytes of the channel 3101 data	421101		
	Higher bytes of the channel 3101 data	421102		
	Lower bytes of the channel 3150 data	421199		
	Higher bytes of the channel 3150 data	421200		
	Lower bytes of the channel 3201 data	421201		
	Higher bytes of the channel 3201 data	421202		
	Lower bytes of the channel 3250 data	421299		
	Higher bytes of the channel 3250 data	421300		
	Lower bytes of the channel 3301 data	421301		
	Higher bytes of the channel 3301 data	421302		
	Lower bytes of the channel 3350 data	421399		
	Higher bytes of the channel 3350 data	421400		
	Lower bytes of the channel 3401 data	421401		
	Higher bytes of the channel 3401 data	421402		
	Lower bytes of the channel 3450 data	421499		
	Higher bytes of the channel 3450 data	421500		
	Lower bytes of the channel 3501 data	421501		
	Higher bytes of the channel 3501 data	421502		
	Lower bytes of the channel 3550 data	421599		
	Higher bytes of the channel 3550 data	421600		
	Sub unit 4	Lower bytes of the channel 4001 data		426001
		Higher bytes of the channel 4001 data		426002
Lower bytes of the channel 4050 data		426099		
Higher bytes of the channel 4050 data		426100		
Lower bytes of the channel 4101 data		426101		
Higher bytes of the channel 4101 data		426102		
Lower bytes of the channel 4150 data		426199		
Higher bytes of the channel 4150 data		426200		
Lower bytes of the channel 4201 data		426201		
Higher bytes of the channel 4201 data		426202		
Lower bytes of the channel 4250 data		426299		
Higher bytes of the channel 4250 data		426300		
Lower bytes of the channel 4301 data		426301		
Higher bytes of the channel 4301 data		426302		
Lower bytes of the channel 4350 data		426399		
Higher bytes of the channel 4350 data		426400		
Lower bytes of the channel 4401 data	426401			
Higher bytes of the channel 4401 data	426402			
Lower bytes of the channel 4450 data	426499			
Higher bytes of the channel 4450 data	426500			
Lower bytes of the channel 4501 data	426501			
Higher bytes of the channel 4501 data	426502			
Lower bytes of the channel 4550 data	426599			
Higher bytes of the channel 4550 data	426600			

Continued on next page

Unit	I/O channel data	Hold register	Data Type
Sub unit 5	Lower bytes of the channel 5001 data	431001	32-bit floating point
	Higher bytes of the channel 5001 data	431002	
	Lower bytes of the channel 5050 data	431099	
	Higher bytes of the channel 5050 data	431100	
	Lower bytes of the channel 5101 data	431101	
	Higher bytes of the channel 5101 data	431102	
	Lower bytes of the channel 5150 data	431199	
	Higher bytes of the channel 5150 data	431200	
	Lower bytes of the channel 5201 data	431201	
	Higher bytes of the channel 5201 data	431202	
	Lower bytes of the channel 5250 data	431299	
	Higher bytes of the channel 5250 data	431300	
	Lower bytes of the channel 5301 data	431301	
	Higher bytes of the channel 5301 data	431302	
	Lower bytes of the channel 5350 data	431399	
	Higher bytes of the channel 5350 data	431400	
	Lower bytes of the channel 5401 data	431401	
	Higher bytes of the channel 5401 data	431402	
	Lower bytes of the channel 5450 data	431499	
	Higher bytes of the channel 5450 data	431500	
	Lower bytes of the channel 5501 data	431501	
	Higher bytes of the channel 5501 data	431502	
Lower bytes of the channel 5550 data	431599		
Higher bytes of the channel 5550 data	431600		
Sub unit 6	Lower bytes of the channel 6001 data	436001	
	Higher bytes of the channel 6001 data	436002	
	Lower bytes of the channel 6050 data	436099	
	Higher bytes of the channel 6050 data	436100	
	Lower bytes of the channel 6101 data	436101	
	Higher bytes of the channel 6101 data	436102	
	Lower bytes of the channel 6150 data	436199	
	Higher bytes of the channel 6150 data	436200	
	Lower bytes of the channel 6201 data	436201	
	Higher bytes of the channel 6201 data	436202	
	Lower bytes of the channel 6250 data	436299	
	Higher bytes of the channel 6250 data	436300	
	Lower bytes of the channel 6301 data	436301	
	Higher bytes of the channel 6301 data	436302	
	Lower bytes of the channel 6350 data	436399	
	Higher bytes of the channel 6350 data	436400	
	Lower bytes of the channel 6401 data	436401	
	Higher bytes of the channel 6401 data	436402	
	Lower bytes of the channel 6450 data	436499	
	Higher bytes of the channel 6450 data	436500	
	Lower bytes of the channel 6501 data	436501	
	Higher bytes of the channel 6501 data	436502	
Lower bytes of the channel 6550 data	436599		
Higher bytes of the channel 6550 data	436600		

• 16-bit signed integer

Unit	I/O channel data	Hold register	Data Type
Main unit	Channel 0001 data	402001	16-bit signed integer
	Channel 0050 data	402050	
	Channel 0101 data	402051	
	Channel 0150 data	402100	
	Channel 0201 data	402101	
	Channel 0250 data	402150	
	Channel 0301 data	402151	
	Channel 0350 data	402200	
	Channel 0401 data	402201	
	Channel 0450 data	402250	
	Channel 0501 data	402251	
	Channel 0550 data	402300	
	Channel 0601 data	402301	
Channel 0650 data	402350		
Channel 0701 data	402351		
Channel 0750 data	402400		
Channel 0801 data	402401		
Channel 0850 data	402450		
Channel 0901 data	402451		
Channel 0950 data	402500		
Sub unit 1	Channel 1001 data	412001	
Channel 1050 data	412050		
Channel 1101 data	412051		
Channel 1150 data	412100		
Channel 1201 data	412101		
Channel 1250 data	412150		
Channel 1301 data	412151		
Channel 1350 data	412200		
Channel 1401 data	412201		
Channel 1450 data	412250		
Channel 1501 data	412251		
Channel 1550 data	412300		
Sub unit 2	Channel 2001 data	417001	
Channel 2050 data	417050		
Channel 2101 data	417051		
Channel 2150 data	417100		
Channel 2201 data	417101		
Channel 2250 data	417150		

Continued on next page

Unit	I/O channel data	Input register	Data Type
Sub unit 2	Channel 2301 data	417151	16-bit signed integer
	Channel 2350 data	417200	
	Channel 2401 data	417201	
	Channel 2450 data	417250	
Sub unit 3	Channel 2501 data	417251	
	Channel 2550 data	417300	
	Channel 3001 data	422001	
	Channel 3050 data	422050	
	Channel 3101 data	422051	
	Channel 3150 data	422100	
	Channel 3201 data	422101	
	Channel 3250 data	422150	
Channel 3301 data	422151		
Channel 3350 data	422200		
Channel 3401 data	422201		
Channel 3450 data	422250		
Channel 3501 data	422251		
Channel 3550 data	422300		
Sub unit 4	Channel 4001 data	427001	
	Channel 4050 data	427050	
	Channel 4101 data	427051	
	Channel 4150 data	427100	
	Channel 4201 data	427101	
	Channel 4250 data	427150	
	Channel 4301 data	427151	
	Channel 4350 data	427200	
	Channel 4401 data	427201	
Channel 4450 data	427250		
Channel 4501 data	427251		
Channel 4550 data	427300		
Sub unit 5	Channel 5001 data	432001	
	Channel 5050 data	432050	
	Channel 5101 data	432051	
	Channel 5150 data	432100	
	Channel 5201 data	432101	
Channel 5250 data	432150		
Channel 5301 data	432151		
Channel 5350 data	432200		

Continued on next page

4.5 Modbus Function and Register Assignments

Unit	I/O channel data	Input register	Data Type
Sub unit 5	Channel 5401 data	432201	16-bit signed integer
	Channel 5450 data	432250	
	Channel 5501 data	432251	
	Channel 5550 data	432300	
Sub unit 6	Channel 6001 data	437001	
	Channel 6050 data	437050	
	Channel 6101 data	437051	
	Channel 6150 data	437100	
	Channel 6201 data	437101	
	Channel 6250 data	437150	
	Channel 6301 data	437151	
	Channel 6350 data	437200	
	Channel 6401 data	437201	
	Channel 6450 data	437250	
	Channel 6501 data	437251	
	Channel 6550 data	437300	

I/O Channel Data Status Information

Unit	I/O channel data	Hold register	Data Type
Main unit	Channel 0001 status information	402501	16-bit signed integer
	Channel 0050 status information	402550	
	Channel 0101 status information	402551	
	Channel 0150 status information	402600	
	Channel 0201 status information	402601	
	Channel 0250 status information	402650	
	Channel 0301 status information	402651	
	Channel 0350 status information	402700	
	Channel 0401 status information	402701	
	Channel 0450 status information	402750	
	Channel 0501 status information	402751	
	Channel 0550 status information	402800	
	Channel 0601 status information	402801	
	Channel 0650 status information	402850	
	Channel 0701 status information	402851	
	Channel 0750 status information	402900	
	Channel 0801 status information	402901	
	Channel 0850 status information	402950	
	Channel 0901 status information	402951	
	Channel 0950 status information	403000	

Continued on next page

Unit	I/O channel data	Input register	Data Type
Sub unit 1	Channel 1001 status information	412501	16-bit signed integer
	Channel 1050 status information	412550	
	Channel 1101 status information	412551	
	Channel 1150 status information	412600	
	Channel 1201 status information	412601	
	Channel 1250 status information	412650	
	Channel 1301 status information	412651	
	Channel 1350 status information	412700	
	Channel 1401 status information	412701	
	Channel 1450 status information	412750	
Channel 1501 status information	412751		
Sub unit 2	Channel 1550 status information	412800	
	Channel 2001 status information	417501	
	Channel 2050 status information	417550	
	Channel 2101 status information	417551	
	Channel 2150 status information	417600	
	Channel 2201 status information	417601	
	Channel 2250 status information	417650	
	Channel 2301 status information	417651	
	Channel 2350 status information	417700	
	Channel 2401 status information	417701	
Channel 2450 status information	417750		
Channel 2501 status information	417751		
Sub unit 3	Channel 2550 status information	417800	
	Channel 3001 status information	422501	
	Channel 3050 status information	422550	
	Channel 3101 status information	422551	
	Channel 3150 status information	422600	
	Channel 3201 status information	422601	
	Channel 3250 status information	422650	
	Channel 3301 status information	422651	
	Channel 3350 status information	422700	
	Channel 3401 status information	422701	
Channel 3450 status information	422750		
Channel 3501 status information	422751		
Channel 3550 status information	422800		

Continued on next page

4.5 Modbus Function and Register Assignments

Unit	I/O channel data	Input register	Data Type
Sub unit 4	Channel 4001 status information	427501	16-bit signed integer
	Channel 4050 status information	427550	
	Channel 4101 status information	427551	
	Channel 4150 status information	427600	
	Channel 4201 status information	427601	
	Channel 4250 status information	427650	
	Channel 4301 status information	427651	
	Channel 4350 status information	427700	
	Channel 4401 status information	427701	
	Channel 4450 status information	427750	
Channel 4501 status information	427751		
Channel 4550 status information	427800		
Sub unit 5	Channel 5001 status information	432501	
	Channel 5050 status information	432550	
	Channel 5101 status information	432551	
	Channel 5150 status information	432600	
	Channel 5201 status information	432601	
	Channel 5250 status information	432650	
	Channel 5301 status information	432651	
	Channel 5350 status information	432700	
	Channel 5401 status information	432701	
	Channel 5450 status information	432750	
Channel 5501 status information	432751		
Channel 5550 status information	432800		
Sub unit 6	Channel 6001 status information	437501	
	Channel 6050 status information	437550	
	Channel 6101 status information	437551	
	Channel 6150 status information	437600	
	Channel 6201 status information	437601	
	Channel 6250 status information	437650	
	Channel 6301 status information	437651	
	Channel 6350 status information	437700	
	Channel 6401 status information	437701	
	Channel 6450 status information	437750	
Channel 6501 status information	437751		
Channel 6550 status information	437800		

- There is no decimal place information.

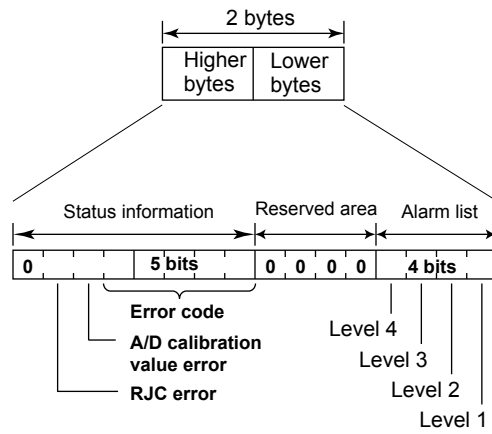

Error code	Meaning
0	No error
1	Skip
2	+Over
3	-Over
4	+Burnout
5	-Burnout
6	A/D error
7	Invalid data
16	Computation error
17	Communication error

Continuous Channel Data Read/Write Area

The GM reserves up to 50 channels of register area per module.

For example, reading 100 channels of data from 10 analog input modules through normal input registers would be inefficient because there would be a lot of empty registers.

The “continuous channel data read/write area” is a special area that enables continuous reading and writing by limiting the number of channels of each module to 10. It is for I/O channels installed in the GM main unit.

I/O Channel Data

- **32-bit signed integer**

I/O channel data	Hold register	Data Type
Lower bytes of the channel 0001 data	404001	32-bit signed integer
Higher bytes of the channel 0001 data	404002	
Lower bytes of the channel 0010 data	404019	
Higher bytes of the channel 0010 data	404020	
Lower bytes of the channel 0101 data	404021	
Higher bytes of the channel 0101 data	404022	
Lower bytes of the channel 0110 data	404039	
Higher bytes of the channel 0110 data	404040	
Lower bytes of the channel 0201 data	404041	
Higher bytes of the channel 0201 data	404042	
Lower bytes of the channel 0210 data	404059	
Higher bytes of the channel 0210 data	404060	
Lower bytes of the channel 0301 data	404061	
Higher bytes of the channel 0301 data	404062	
Lower bytes of the channel 0310 data	404079	
Higher bytes of the channel 0310 data	404080	
Lower bytes of the channel 0401 data	404081	
Higher bytes of the channel 0401 data	404082	
Lower bytes of the channel 0410 data	404099	
Higher bytes of the channel 0410 data	404100	
Lower bytes of the channel 0501 data	404101	
Higher bytes of the channel 0501 data	404102	
Lower bytes of the channel 0510 data	404119	
Higher bytes of the channel 0510 data	404120	
Lower bytes of the channel 0601 data	404121	
Higher bytes of the channel 0601 data	404122	
Lower bytes of the channel 0610 data	404139	
Higher bytes of the channel 0610 data	404140	
Lower bytes of the channel 0701 data	404141	
Higher bytes of the channel 0701 data	404142	
Lower bytes of the channel 0710 data	404159	
Higher bytes of the channel 0710 data	404160	
Lower bytes of the channel 0801 data	404161	
Higher bytes of the channel 0801 data	404162	
Lower bytes of the channel 0810 data	404179	
Higher bytes of the channel 0810 data	404180	
Lower bytes of the channel 0901 data	404181	
Higher bytes of the channel 0901 data	404182	
Lower bytes of the channel 0910 data	404199	
Higher bytes of the channel 0910 data	404200	

- **32-bit floating point**

I/O channel data	Hold register	Data Type
Lower bytes of the channel 0001 data	404201	32-bit floating point
Higher bytes of the channel 0001 data	404202	
Lower bytes of the channel 0010 data	404219	
Higher bytes of the channel 0010 data	404220	
Lower bytes of the channel 0101 data	404221	
Higher bytes of the channel 0101 data	404222	
Lower bytes of the channel 0110 data	404239	
Higher bytes of the channel 0110 data	404240	
Lower bytes of the channel 0201 data	404241	
Higher bytes of the channel 0201 data	404242	
Lower bytes of the channel 0210 data	404259	
Higher bytes of the channel 0210 data	404260	
Lower bytes of the channel 0301 data	404261	
Higher bytes of the channel 0301 data	404262	
Lower bytes of the channel 0310 data	404279	
Higher bytes of the channel 0310 data	404280	
Lower bytes of the channel 0401 data	404281	
Higher bytes of the channel 0401 data	404282	
Lower bytes of the channel 0410 data	404299	
Higher bytes of the channel 0410 data	404300	
Lower bytes of the channel 0501 data	404301	
Higher bytes of the channel 0501 data	404302	
Lower bytes of the channel 0510 data	404319	
Higher bytes of the channel 0510 data	404320	
Lower bytes of the channel 0601 data	404321	
Higher bytes of the channel 0601 data	404322	
Lower bytes of the channel 0610 data	404339	
Higher bytes of the channel 0610 data	404340	
Lower bytes of the channel 0701 data	404341	
Higher bytes of the channel 0701 data	404342	
Lower bytes of the channel 0710 data	404359	
Higher bytes of the channel 0710 data	404360	
Lower bytes of the channel 0801 data	404361	
Higher bytes of the channel 0801 data	404362	
Lower bytes of the channel 0810 data	404379	
Higher bytes of the channel 0810 data	404380	
Lower bytes of the channel 0901 data	404381	
Higher bytes of the channel 0901 data	404382	
Lower bytes of the channel 0910 data	404399	
Higher bytes of the channel 0910 data	404400	

• **16-bit signed integer**

I/O channel data	Hold register	Data Type
Channel 0001 data	404401	16-bit signed integer
Channel 0010 data	404410	
Channel 0101 data	404411	
Channel 0110 data	404420	
Channel 0201 data	404421	
Channel 0210 data	404430	
Channel 0301 data	404431	
Channel 0310 data	404440	
Channel 0401 data	404441	
Channel 0410 data	404450	
Channel 0501 data	404451	
Channel 0510 data	404460	
Channel 0601 data	404461	
Channel 0650 data	404470	
Channel 0701 data	404471	
Channel 0710 data	404480	
Channel 0801 data	404481	
Channel 0810 data	404490	
Channel 0901 data	404491	
Channel 0910 data	404500	

I/O Channel Data Status Information

I/O channel data	Hold register	Data Type
Channel 0001 status information	404501	16-bit signed integer
Channel 0010 status information	404510	
Channel 0101 status information	404511	
Channel 0110 status information	404520	
Channel 0201 status information	404521	
Channel 0210 status information	404530	
Channel 0301 status information	404531	
Channel 0310 status information	404540	
Channel 0401 status information	404541	
Channel 0410 status information	404550	
Channel 0501 status information	404551	
Channel 0510 status information	404560	
Channel 0601 status information	404561	
Channel 0610 status information	404570	
Channel 0701 status information	404571	
Channel 0710 status information	404580	
Channel 0801 status information	404581	
Channel 0810 status information	404590	
Channel 0901 status information	404591	
Channel 0910 status information	404600	

• There is no decimal place information.

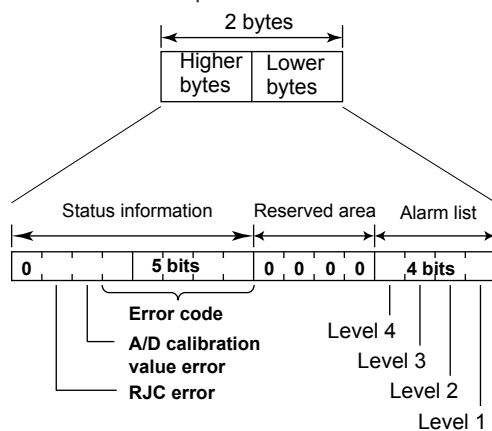

Error code	Meaning
0	No error
1	Skip
2	+Over
3	-Over
4	+Burnout
5	-Burnout
6	A/D error
7	Invalid data
16	Computation error
17	Communication error

Communication Channel

Data	Hold register	Data Type
Lower bytes of the input data of channel C001	405001	32-bit signed integer
Higher bytes of the input data of channel C001	405002	
Lower bytes of the input data of channel C500	405999	32-bit floating point
Higher bytes of the input data of channel C500	406000	
• There is no decimal place information.		
Lower bytes of the input data of channel C001	406001	32-bit floating point
Higher bytes of the input data of channel C001	406002	
Lower bytes of the input data of channel C500	406999	32-bit floating point
Higher bytes of the input data of channel C500	407000	
• Note when a client (master) device writes data		
Input range: -9.9999E29 to -1E-30, 0, 1E-30 to 9.9999E29		
Values outside this range when used in a math channel will result in computation error.		
Channel C001 input data	407001	16-bit signed integer
Channel C500 input data	407500	
Channel C001 status information	407501	
Channel C500 status information	408000	
• Status register configuration		
This is the same as that of the I/O channel data status information.		

Internal Switch*

Data	Hold register	Supplementary Information	Data Type
S001 input data	408001	OFF: 0, ON: Not 0	16-bit signed integer
S100 input data	408100	OFF: 0, ON: Not 0	

* To control internal switches through Modbus writing, the internal switch must be set to **Manual**.
 ► See page 2-185 in section 2.26.5, "Setting Internal Switches".

GM operation setting

Data	Hold register	Supplementary Information	Data Type
Starts or stops recording (without multi batch)	409001	0: Fixed at 0 when reading 1: Start recording	16-bit signed integer
Multi batch 1 to 12	409001	2: Stop recording	
Recording start or stop	 409012		
Computation operation (without multi batch)	409021	0: Fixed at 0 when reading 1: Start computation (all)	16-bit signed integer
Multi batch 1 to 12	409021	2: Stop computation (all)	
Computation operation	 409032	3: Reset computation (by batch) 4: Clear the computation dropout status display (all)	
All alarm ACK	409041	0: Fixed at 0 when reading 1: Clear alarm output	
Individual alarm ACK	409042	Alarm ACK channel type specification 0: Fixed at 0 when reading 1: I/O channel 2: Math channel 3: Communication channel	

Continued on next page

Data	Hold register	Supplementary Information Data Type
Individual alarm ACK	409043	Alarm ACK channel number 16-bit signed integer specification 0: Fixed at 0 when reading I/O channel: 1 to 6932 Math channel: 1 to 200 Communication channel: 1 to 500
	409044	Alarm ACK alarm level specification 0: Fixed at 0 when reading 1: Alarm level 1 ACK 2: Alarm level 2 ACK 3: Alarm level 3 ACK 4: Alarm level 4 ACK
Manual trigger, manual sample, snapshot, timeout	409051	0: Fixed at 0 when reading 1: Execute manual sampling 2: Generate a manual trigger 3: Take a snapshot 4: Cause a timeout in display data 5: Cause a timeout in event data
Synchronize time using SNTP	409052	0: Fixed at 0 when reading 1: Execute manual SNTP
Start/stop the e-mail transmission function	409053	0: Fixed at 0 when reading 1: Start e-mail transmission 2: Stop e-mail transmission
Recover Modbus manually	409054	0: Fixed at 0 when reading 1: Manually recover the Modbus client. 2: Manually recover the Modbus master.
Reset a relative timer	409055	0: Fixed at 0 when reading 1 to 12: Reset the specified timer 100: Reset all timers
Reset a match time timer	409056	0: Fixed at 0 when reading 1 to 12: Reset the specified timer 100: Reset all timers
All loop control run/stop	409057	1: All loops run 2: All loops stop
Load profile trend	409058	0: Fixed at 0 when reading 1 to 10000: Load the file with the specified number from the SD card File name: Profile/Profile + Number.GPF *Create a Profile folder in the root in advance
Load predictive detection model	409059	0: Fixed at 0 when reading 1 to 10000: Load the file with the specified number from the SD card File name: Profile/Profile + Number.GPF *Create a Profile folder in the root in advance
Predictive detection section start/stop	409060	0: Fixed at 0 when reading 1: Predictive detection section start 2: Predictive detection section stop
HOLD profile trend On/Off	409061	0: Fixed at 0 when reading 1: Hold On 2: Hold Off

Continued on next page

4.5 Modbus Function and Register Assignments

Data	Hold register	Supplementary Information	Data Type
Property display area display information settings	409091	0: Range, unit, tag name information of continuous measurement channels 0001 to 6510 10: Range, unit, tag name information of math channels 0001 to 950 11: Range, unit, tag name information of math channels 1001 to 1950 12: Range, unit, tag name information of math channels 2001 to 2950 13: Range, unit, tag name information of math channels 3001 to 3950 14: Range, unit, tag name information of math channels 4001 to 4950 15: Range, unit, tag name information of math channels 5001 to 5950 16: Range, unit, tag name information of math channels 6001 to 6950 20: Range, unit, tag name information of math channels A001 to A200 30: Range, unit, tag name information of communication channels C001 to C500	16-bit signed integer
Year	409101*	0 to 65535	
Month	409102*	1 to 12	
Day	409103*	1 to 31	
Hour	409104*	0 to 23	
Minute	409105*	0 to 59	
Second	409106*	0 to 59	
* Read only. Cannot be written to.			
Write a message (specify the write method)	409201	0: Fixed at 0 when reading 1: Write a preset message 2: Write a free message	16-bit signed integer
Write a message (message number)	409202	0: Fixed at 0 when reading Preset: 1 to 100 Free: 1 to 10	
Write a message (specify the write destination)	409203	0: All display groups; fixed at 0 when reading 1 or greater: The specified display group	
Write a message (batch group number)	409204	0: Fixed at 0 when reading 1 or greater: Batch group number	
Write a message (free message)	409205	0: Fixed at 0 when reading UTF-8 characters (2 characters) Up to 32 characters Ignored for preset messages Attach a terminator at the end	
Write a message (free message)	409230	0: Fixed at 0 when reading UTF-8 characters (2 characters) Up to 32 characters Ignored for preset messages Attach a terminator at the end	

Continued on next page

Data	Hold register	Supplementary Information	Data Type
Batch, lot number	409301	Lower bytes of the lot number	32-bit signed integer
	409302	Higher bytes of the lot number	
	409303	Batch number UTF-8 characters (2 characters) Up to 32 characters [attach the terminator '\0' at the end]	16-bit signed integer
	409319	Batch number UTF-8 characters (2 characters) Up to 32 characters [attach the terminator '\0' at the end]	
Batch, lot number (multi batch support)	409351	1 or greater: Batch group number When reading, the batch group number that performed writing previously Default value: 0	16-bit signed integer
	409352	Lower bytes of the lot number When reading, the lot number corresponding to the above batch group number 0 if there is no corresponding batch group number	32-bit signed integer
	409353	Higher bytes of the lot number When reading, the lot number corresponding to the above batch group number 0 if there is no corresponding batch group number	
	409354	Batch number UTF-8 characters (2 characters) Up to 32 characters [attach the terminator '\0' at the end] When reading, the batch number corresponding to the above batch group number NULL character if there is no corresponding batch group number	16-bit signed integer
	409379	Batch number UTF-8 characters (2 characters) Up to 32 characters [attach the terminator '\0' at the end] When reading, the batch number corresponding to the above batch group number NULL character if there is no corresponding batch group number	
Batch comment	409401	1 to 12: Batch group number When reading, the batch group number that performed writing previously Default value: 0 Without multi batch: 1	16-bit signed integer
	409402	1 or greater: Batch group number When reading, the batch group number that performed writing previously Default value: 0	16-bit signed integer

Continued on next page

4.5 Modbus Function and Register Assignments

Data	Hold register	Supplementary Information	Data Type
Batch comment	409403	Comment string UTF-8 characters (2 characters) Up to 50 characters [attach the terminator '\0' at the end] When reading, the batch comment text corresponding to the above batch group number and batch comment number NULL character if there is no corresponding batch group number or batch comment number	
	409428	Comment string UTF-8 characters (2 characters) Up to 50 characters [attach the terminator '\0' at the end] When reading, the batch comment text corresponding to the above batch group number and batch comment number NULL character if there is no corresponding batch group number or batch comment number	
Batch text field title	409451	1 to 12: Batch group number When reading, the batch group number that performed writing previously Default value: 0 Without multi batch: 1	16-bit signed integer
	409452	Batch text Text field number When reading, the batch text field number that performed writing previously Default value: 0	
	409453	Batch Text field Title UTF-8 characters (2 characters) Up to 20 characters [attach the terminator '\0' at the end] When reading, the batch field title text corresponding to the above batch group number and batch text field number NULL character if there is no corresponding batch group number or batch text field number	

Continued on next page

Data	Hold register	Supplementary Information	Data Type
Batch text field title	409478	Batch Text field Title UTF-8 characters (2 characters) Up to 20 characters [attach the terminator '\0' at the end] When reading, the batch field title text corresponding to the above batch group number and batch text field number NULL character if there is no corresponding batch group number or batch text field number	16-bit signed integer
Batch text field characters	409501	1 to 12: Batch group number When reading, the batch group number that performed writing previously Default value: 0 Without multi batch: 1	16-bit signed integer
	409502	Batch text Text field number When reading, the batch text field number that performed writing previously Default value: 0	
	409503	Batch Text field Characters UTF-8 characters (2 characters) Up to 30 characters [attach the terminator '\0' at the end] When reading, the batch field text corresponding to the above batch group number and batch text field number NULL character if there is no corresponding batch group number or batch text field number	
	409528	Batch Text field Characters UTF-8 characters (2 characters) Up to 30 characters [attach the terminator '\0' at the end] When reading, the batch field text corresponding to the above batch group number and batch text field number NULL character if there is no corresponding batch group number or batch text field number	
Program operation pattern number switching	409601	1 to 99 Communication pattern number reading and writing when read	
Program operation switching	409601	1: Program operation stop 2: Program operation run When read, 1: Program operation stop 2: Program operation running	
Hold-on switching	409603	1: Release hold 2: Hold When read, 1: Program running 2: Holding	

Continued on next page

4.5 Modbus Function and Register Assignments

Data	Hold register	Supplementary Information	Data Type
Advance instruction	409604	1: Advance instruction Always 0 when read	
Alarm setting (channel type)	409701	1: I/O channel 2: Math channel 3: Communication channel Channel type of the alarm that wrote previously when read Default value: 0	16-bit signed integer
Alarm setting (channel number)	409702	I/O channel: 1 to 6932 Math channel: 1 to 200 Communication channel: 1 to 500 Channel number of the alarm that wrote previously when read Default value: 0	
Alarm setting (alarm level)	409703	1 to 4: Alarm level Alarm level of the alarm that wrote previously when read Default value: 0	
Alarm type	409704	0: OFF 1: High limit alarm 2: Low limit alarm 3: High limit on rate-of-change alarm 4: Low limit on rate-of-change alarm 5: Delay high limit alarm 6: Delay low limit alarm 7: Difference high limit alarm 8: Difference low limit alarm 10: Profile high limit alarm 11: Profile low limit alarm Alarm type corresponding to the above channel type, channel number, and alarm level when read	
Alarm setpoint	409705 409706	Alarm setpoint Alarm setpoint corresponding to the above channel type, channel number, and alarm level when read	32-bit signed integer
Alarm delay setting (channel type)	409711	1: I/O channel 2: Math channel 3: Communication channel Channel type of the alarm that wrote previously when read Default value: 0	16-bit signed integer
Alarm delay setting (channel number)	409712	I/O channel: 1 to 6932 Math channel: 1 to 200 Communication channel: 1 to 500 Channel number of the alarm that wrote previously when read Default value: 0	
Alarm delay	409713 409714	Alarm delay seconds Alarm delay corresponding to the channel type and channel number when read	32-bit signed integer
Section setting for prediction (Trigger type)	409721	1: Threshold 2: Sync with recording 3: External signal	16-bit signed integer
Section setting for prediction (Channel type)	409722	1: I/O channel 2: Math channel 3: Communication channel	

Continued on next page

Data	Hold register	Supplementary Information	Data Type
Section setting for prediction (Channel number)	409723	I/O channel: 1 to 6932 Math channel: 1 to 200 Communication channel: 1 to 500	16-bit signed integer
Section setting for prediction (Start condition: Threshold)	409724 409725	Threshold	32-bit signed integer
Section setting for prediction (Start condition: Judgement)	409726	1: Or more 2: Less	16-bit signed integer
Section setting for prediction (End condition: Threshold)	409727 409728	Threshold	32-bit signed integer
Section setting for prediction (End condition: Judgement)	409729	1: Or more 2: Less	16-bit signed integer
Section setting for prediction (Repeat start condition)	409730	1: Recording 2: External signal	
Section setting for prediction (Number of repeat data)	409731	Number of data 20 to 30000	

4.5.6 Coil

Coil registers can only be accessed from the main unit channels. The coil area is both readable and writable. The registers contain 1-bit data. The registers take on the value of 0 when the data is 0 and the value of 1 otherwise to indicate the data or status.

I/O channel data

Type	I/O channel data	Register	Read/Write	Data Type
I/O Channel Data	Channel 0001 data	00001	R/W	Bit string
	Channel 0050 data	00050		
	Channel 0101 data	00051		
	Channel 0150 data	00100		
	Channel 0201 data	00101		
	Channel 0250 data	00150		
	Channel 0301 data	00151		
	Channel 0350 data	00200		
	Channel 0401 data	00201		
	Channel 0450 data	00250		
	Channel 0501 data	00251		
	Channel 0550 data	00300		
	Channel 0601 data	00301		
	Channel 0650 data	00350		
	Channel 0701 data	00351		
	Channel 0750 data	00400		
	Channel 0801 data	00401		
	Channel 0850 data	00450		
	Channel 0901 data	00451		
	Channel 0950 data	00500		
I/O Channel Data Status Information	Channel 0001 data	00501	R	Bit string
	Channel 0050 data	00550		
	Channel 0101 data	00551		
	Channel 0150 data	00600		
	Channel 0201 data	00601		
	Channel 0250 data	00650		
	Channel 0301 data	00651		
	Channel 0350 data	00700		
	Channel 0401 data	00701		
	Channel 0450 data	00750		
I/O Channel Data Status Information	Channel 0601 data	00801	R	Bit string
	Channel 0650 data	00850		
	Channel 0701 data	00851		
	Channel 0750 data	00900		

Continued on next page

Type	I/O channel data	Register	Read/Write	Data Type
I/O Channel Data Status Information	Channel 0801 data	00901	R	Bit string
	Channel 0850 data	00950		
	Channel 0901 data	00951		
	Channel 0950 data	01000		

Communication channel data

Type	Communication Channel Data	Register	Read/Write	Data Type
Communication channel data	Channel C001 data	01001	R/W	Bit string
	Channel C300 data	01300		
Communication channel status information	Channel C001 data	01501	R	
	Channel C300 data	01800		

Internal Switch Data

Type	Internal Switch Data	Register	Read/Write	Data Type
Internal Switch Data	Internal switch S001 data	02001	R/W	Bit string
	Internal switch S100 data	02100		

4.5.7 Input Relay

Input relay registers can only be accessed from the main unit channels.

The input relay area is read-only. The registers contain 1-bit data. The registers take on the value of 0 when the data is 0 and the value of 1 otherwise to indicate the data or status.

I/O channel data

Type	I/O channel data	Register	Read/Write	Data Type
I/O Channel Data	Channel 0001 data	10001	R	Bit string
	Channel 0050 data	10050		
	Channel 0101 data	10051		
	Channel 0150 data	10100		
	Channel 0201 data	10101		
	Channel 0250 data	10150		
	Channel 0301 data	10151		
	Channel 0350 data	10200		
	Channel 0401 data	10201		
Channel 0450 data	10250			
Channel 0501 data	10251			
Channel 0550 data	10300			
I/O Channel Data	Channel 0601 data	10301	R	Bit string
	Channel 0650 data	10350		
	Channel 0701 data	10351		
	Channel 0750 data	10400		
Channel 0801 data	10401			
Channel 0850 data	10450			
I/O Channel Data	Channel 0901 data	10451	R	Bit string
	Channel 0950 data	10500		

Continued on next page

4.5 Modbus Function and Register Assignments

Type	I/O channel data	Register	Read/Write	Data Type
I/O Channel Data Status Information	Channel 0001 data	10501	R	Bit string
	Channel 0050 data	10550		
	Channel 0101 data	10551		
	Channel 0150 data	10600		
	Channel 0201 data	10601		
	Channel 0250 data	10650		
	Channel 0301 data	00651		
	Channel 0350 data	10700		
	Channel 0401 data	10701		
	Channel 0450 data	10750		
	Channel 0501 data	10751		
	Channel 0550 data	10800		
	Channel 0601 data	10801		
Channel 0650 data	10850			
Channel 0701 data	10851			
Channel 0750 data	10900			
Channel 0801 data	10901			
Channel 0850 data	10950			
Channel 0901 data	10951			
Channel 0950 data	11000			

Math Channel Data

Type	Math Channel Data	Register	Read/Write	Data Type
Math channel data	Channel A001 data	11001	R	Bit string
Math channel status information	Channel A200 data	11200	R	
	Channel A001 data	11501		
	Channel A200 data	11700		

4.5.8 Property area

Property area is a register area in which the data that can be read can be changed by changing the channel property change register value.

Item	Description
Property area range	440000 to 465000 (hold register)
Channel property change register	409091 (hold register)

Setting Register

Channel property change register

Type	Register	Data type	Supplementary description
Property area display information setting	409091	16-bit signed integer	0: Range, unit, tag name information of continuous measurement channels 0001 to 6510 10: Range, unit, tag name information of I/O channels 0001 to 0950 11: Range, unit, tag name information of I/O channels 1001 to 1950 12: Range, unit, tag name information of I/O channels 2001 to 2950 13: Range, unit, tag name information of I/O channels 3001 to 3950 14: Range, unit, tag name information of I/O channels 4001 to 4950 15: Range, unit, tag name information of I/O channels 5001 to 5950 16: Range, unit, tag name information of I/O channels 6001 to 6950 20: Range, unit, tag name information of math channels A001 to A200 30: Range, unit, tag name information of communication channels C001 to C500

Property Details

Property 0 (for continuous measurement channel information)

Indicates zero for read-only registers and when registers are not present.

Unit	I/O channel information	Start register	End register	Register type
Main unit	Channel 0001 information	440001	440040	16-bit signed integer
	Channel 0002 information	440041	440080	
	Channel 0010 information	440361	440400	
	Channel 0101 information	440401	440440	
	Channel 0102 information	440441	440480	
	Channel 0110 information	440761	440800	
	Channel 0201 information	440801	440840	
	Channel 0202 information	440841	440880	
	Channel 0210 information	441161	441200	
	Channel 0301 information	441201	441240	
	Channel 0302 information	441241	441280	
	Channel 0310 information	441561	441600	
	Channel 0401 information	441601	441640	
	Channel 0402 information	441641	441680	
	Channel 0410 information	441961	442000	
	Channel 0501 information	442001	442040	
	Channel 0502 information	442041	442080	
	Channel 0510 information	442361	442400	
	Channel 0601 information	442401	442440	
	Channel 0602 information	442441	442480	
	Channel 0610 information	442761	442800	
Channel 0701 information	442801	442840		
Channel 0702 information	442841	442880		
Channel 0710 information	443161	443200		
Channel 0801 information	443201	443240		
Channel 0802 information	443241	443280		
Channel 0810 information	443561	443600		
Channel 0901 information	443601	443640		
Channel 0902 information	443641	443680		
Channel 0910 information	443961	444000		
Sub unit 1	Channel 1001 information	444001	444040	
	Channel 1002 information	444041	444080	
	Channel 1010 information	444361	444400	
	Channel 1101 information	444401	444440	
	Channel 1102 information	444441	444480	
	Channel 1110 information	444761	444800	
	Channel 1201 information	444801	444840	
	Channel 1202 information	444841	444880	
Channel 1210 information	445161	445200		

Continued on next page

Unit	I/O channel information	Start register	End register	Register type	
Sub unit 1	Channel 1301 information	445201	445240	16-bit signed integer	
	Channel 1302 information	445241	445280		
	Channel 1310 information	445561	445600		
	Channel 1401 information	445601	445640		
	Channel 1402 information	445641	445680		
	Channel 1410 information	445961	446000		
	Channel 1501 information	446001	446040		
	Channel 1502 information	446041	446080		
	Channel 1510 information	446361	446400		
	Sub unit 2	Channel 2001 information	446401		446440
	Channel 2002 information	446441	446480		
Channel 2010 information	446761	446800			
Channel 2101 information	446801	446840			
Channel 2102 information	446841	446880			
Channel 2110 information	447161	447200			
Channel 2201 information	447201	447240			
Channel 2202 information	447241	447280			
Channel 2210 information	447561	447600			
Channel 2301 information	447601	447640			
Channel 2302 information	447641	447680			
Channel 2310 information	447961	448000			
Channel 2401 information	448001	448040			
Channel 2402 information	448041	448080			
Channel 2410 information	448361	448400			
Channel 2501 information	448401	448440			
Channel 2502 information	448441	448480			
Channel 2510 information	448761	448800			
Sub unit 3	Channel 3001 information	448801	448840		
Channel 3002 information	448841	448880			
Channel 3010 information	449161	449200			
Channel 3101 information	449201	449240			
Channel 3102 information	449241	449280			
Channel 3110 information	449561	449600			
Channel 3201 information	449601	449640			
Channel 3202 information	449641	449680			
Channel 3210 information	449961	450000			
Channel 3301 information	450001	450040			
Channel 3302 information	450041	450080			
Channel 3310 information	450361	450400			
Channel 3401 information	450401	450440			
Channel 3402 information	450441	450480			
Channel 3410 information	450761	450800			

Continued on next page

4.5 Modbus Function and Register Assignments

Unit	I/O channel information	Start register	End register	Register type	
Sub unit 3	Channel 3501 information	450801	450840	16-bit signed integer	
	Channel 3502 information	450841	450880		
	Channel 3510 information	451161	451200		
Sub unit 4	Channel 4001 information	451201	451240		
	Channel 4002 information	451241	451280		
	Channel 4010 information	451561	451600		
	Channel 4101 information	451601	451640		
	Channel 4102 information	451641	451680		
	Channel 4110 information	451961	452000		
	Channel 4201 information	452001	452040		
	Channel 4202 information	452041	452080		
	Channel 4210 information	452361	452400		
	Channel 4301 information	452401	452440		
	Channel 4302 information	452441	452480		
	Channel 4310 information	452761	452800		
	Channel 4401 information	452801	452840		
	Channel 4402 information	452841	452880		
	Channel 4410 information	453161	453200		
	Channel 4501 information	453201	453240		
	Channel 4502 information	453241	453280		
	Channel 4510 information	453561	453600		
	Sub unit 5	Channel 5001 information	453601	453640	
		Channel 5002 information	453641	453680	
Channel 5010 information		453961	454000		
Channel 5101 information		454001	454040		
Channel 5102 information		454041	451080		
Channel 5110 information		454361	454400		
Channel 5201 information		454401	454440		
Channel 5202 information		454441	454480		
Channel 5210 information		454761	454800		
Channel 5301 information		454801	454840		
Channel 5302 information		454841	454880		
Channel 5310 information		455161	455200		
Channel 5401 information		455201	455240		
Channel 5402 information		455241	455280		
Channel 5410 information		455561	455600		
Channel 5501 information	455601	455640			
Channel 5502 information	455641	455680			
Channel 5510 information	455961	456000			

Continued on next page

Unit	I/O channel information	Start register	End register	Register type
Sub unit 6	Channel 6001 information	456001	456040	16-bit signed integer
	Channel 6002 information	456041	456080	
	Channel 6010 information	456361	456400	
	Channel 6101 information	456401	456440	
	Channel 6102 information	456441	456480	
	Channel 6110 information	456761	456800	
	Channel 6201 information	456801	456840	
	Channel 6202 information	456841	456880	
	Channel 6210 information	457161	457200	
	Channel 6301 information	457201	457240	
	Channel 6302 information	457241	457280	
	Channel 6310 information	457561	457600	
	Channel 6401 information	457601	457640	
	Channel 6402 information	457641	457680	
	Channel 6410 information	457961	458000	
Channel 6501 information	458001	458040		
Channel 6502 information	458041	458080		
Channel 6510 information	458361	458400		

Property 10 to 16 (for I/O channel information)

The relationship between the property number and I/O channel is as follows.

Property number	Unit	Unit number (X)	I/O channel
10	Main unit	0	0001 to 0950
11	Sub unit 1	1	1001 to 1550
12	Sub unit 2	2	2001 to 2550
13	Sub unit 3	3	3001 to 3550
14	Sub unit 4	4	4001 to 4550
15	Sub unit 5	5	5001 to 5550
16	Sub unit 6	6	6001 to 6550

Indicates zero for read-only registers and when registers are not present.

“X” in the channel number is the unit number.

I/O channel information	Start register	End register	Register type
Channel X001 information	440001	440040	16-bit signed integer
Channel X002 information	440041	440080	
Channel X050 information	441961	442000	
Channel X101 information	442001	442040	
Channel X102 information	442041	442080	
Channel X150 information	443961	444000	
Channel X201 information	444001	444040	
Channel X202 information	444041	444080	
Channel X250 information	445961	446000	
Channel X301 information	446001	446040	
Channel X302 information	446041	446080	
Channel X350 information	447961	448000	
Channel X401 information	448001	448040	
Channel X402 information	448041	448080	
Channel X450 information	449961	450000	
Channel X501 information	450001	450040	
Channel X502 information	450041	450080	
Channel X550 information	451961	452000	
Channel X601 information	452001	452040	
Channel X602 information	452041	452080	
Channel X650 information	453961	451000	
Channel X701 information	454001	454040	
Channel X702 information	454041	454080	
Channel X750 information	455961	456000	
Channel X801 information	456001	456040	
Channel X802 information	456041	456080	
Channel X850 information	457961	458000	
Channel X901 information	458001	458040	
Channel X902 information	458041	458080	
Channel X950 information	459961	460000	

Property 20 (for math channel information)

Indicates zero for read-only registers and when registers are not present.

I/O channel information	Start register	End register	Register type
Channel A001 information	440001	440040	16-bit signed integer
Channel A002 information	440041	440080	
Channel A200 information	447961	448000	

Property 30 (for communication channel information)

Indicates zero for read-only registers and when registers are not present.

I/O channel information	Start register	End register	Register type
Channel C001 information	440001	440040	16-bit signed integer
Channel C002 information	440041	440080	
Channel C500 information	459961	460000	

Channel Property Details**I/O Channel Information Details**

Item	Start register	End register	Register type	Remarks
High limit range	440001	440002	32-bit signed integer	When the computation type is Off or Delta: The span upper limit is output. When the computation type is Linear scaling or Square root: The scale 100% value is output. When the computation type is log input, pseudo-log input, or linear-log input: 0 is output.
Low limit range	440003	440004		When the computation type is Off or Delta: The span lower limit is output. When the computation type is Linear scaling or Square root: The scale 0% value is output. When the computation type is log input, pseudo-log input, or linear-log input: 0 is output.
Decimal place	440005	440005	16-bit signed integer	When the computation type is Off or Delta: The span decimal place is output. When the computation type is Linear scaling or Square root: The scale decimal place is output. When the computation type is log input, pseudo-log input, or linear-log input: 0 is output.
Unit	440006	440013		UTF-8 character string Up to 6 characters (15 bytes) A terminator is added to the end.
Tag name	440014	440040		UTF-8 character string Up to 32 characters (53 bytes) A terminator is added to the end.

Blank

5.1 Maintenance

5.1.1 Periodic Inspection

Check the operation periodically to keep the GM in good working order. Perform the following inspections, and replace worn parts as needed.

- Is the display and storage functioning properly?
If not, see section 5.2, "Troubleshooting."
- If replacement is necessary, see section 5.1.4, "Recommended Replacement Periods for Worn Parts."

5.1.2 Calibrating Modules

To maintain measurement and output accuracy, we recommend that you calibrate AI modules once a year.

YOKOGAWA dealers can provide calibration servicing.

For details, contact your nearest YOKOGAWA dealer.

Calibrating AI Modules

Required Instruments

To calibrate the AI modules, you need calibration instruments with the following accuracy and resolution.

Recommended Instruments

- DC voltage standard : Must meet the following specifications (M/9100 by FLUKE or equivalent)
Voltage output range: 20 mV to 100 V
Output accuracy of output range: $\pm(0.01\%+1 \mu\text{V})$ or better

Must meet the following specifications (for mA modules, Yokogawa Meters & Instruments GS200 or equivalent)
Current output range: 0 mA to 20 mA
Setting output accuracy: $\pm(0.03\%$ of setting + 5 $\mu\text{A})$ or better
- Resistance standard : Must meet the following specifications (ADR3204 by Alpha Electronics or equivalent)
Resistance setting range (resolution): 0.2 to 1999 Ω (0.001 Ω),
0.2 to 19999 Ω (0.01 Ω)
Resistance accuracy of the resistance setting range: $\pm (0.01\%$ of + 2 m Ω) or better
- Digital multimeter : Must meet the following specifications (for mA modules)
Agilent 3458A or equivalent
Current measurement range: 100 mA
Measurement accuracy: 35 ppm of reading + 5 ppm of range
- 0°C standard temperature device : ZC-114/ZA-10 by Coper Electronics or equivalent
Main specifications
Standard temperature stability accuracy: $\pm 0.05^\circ\text{C}$

For information on purchasing these calibration instruments, contact your nearest YOKOGAWA dealer.

Calibration Procedure

- 1 Wire the GM and the calibration instruments as shown in the following figure, and adequately warm up the instruments (the warm-up time of the GM is at least 30 minutes).
 Note: The wiring diagram is an example for the universal, 4-wire RTD/resistor type. For details on wiring, see "Installation and Wiring" in the First Step Guide (IM 04L51B01-02EN).
- 2 Check that the operating environment such as ambient temperature and humidity is within the standard operating conditions (see "General Specifications").
- 3 Apply appropriate input signals corresponding to 0, 50, and 100% of the input range and calculate the errors from the readings. For current (mA) modules, the error is determined from the difference between the measured value and the digital multimeter value. For the high-speed universal type, each channel needs to be calibrated. If the error does not fall within the accuracy range of the specifications, servicing is required. Contact your nearest YOKOGAWA dealer.

You can also perform the A/D calibration and adjust the GM within the accuracy specifications. Follow the instructions in section 5.1.3, "Performing A/D Calibration and Adjusting the Input Accuracy."

Note

For thermocouple inputs, you must measure the temperature of the input terminal and apply a voltage taking into account the reference junction temperature.

DC Voltage Measurement

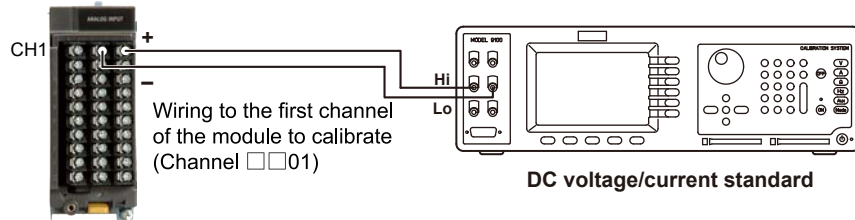

Temperature or Resistance Measurement Using an RTD Three Wire System

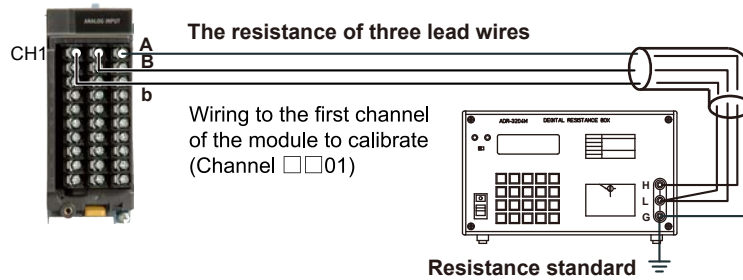

Four Wire System

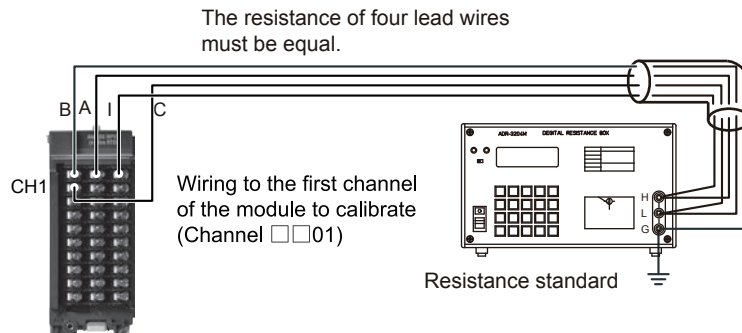

Current (mA) Input

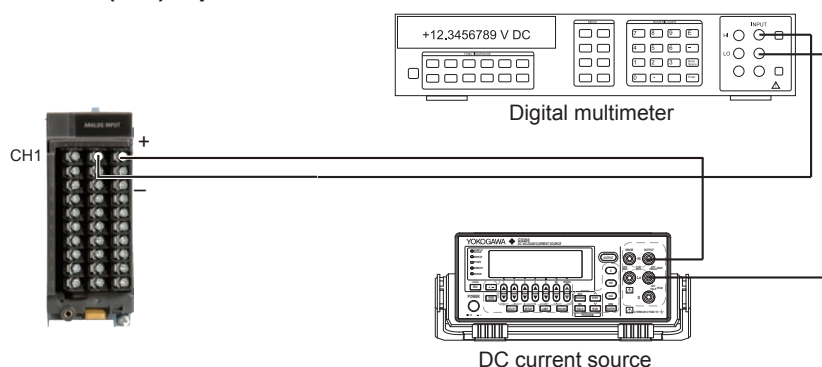

Temperature Measurement Using a Thermocouple

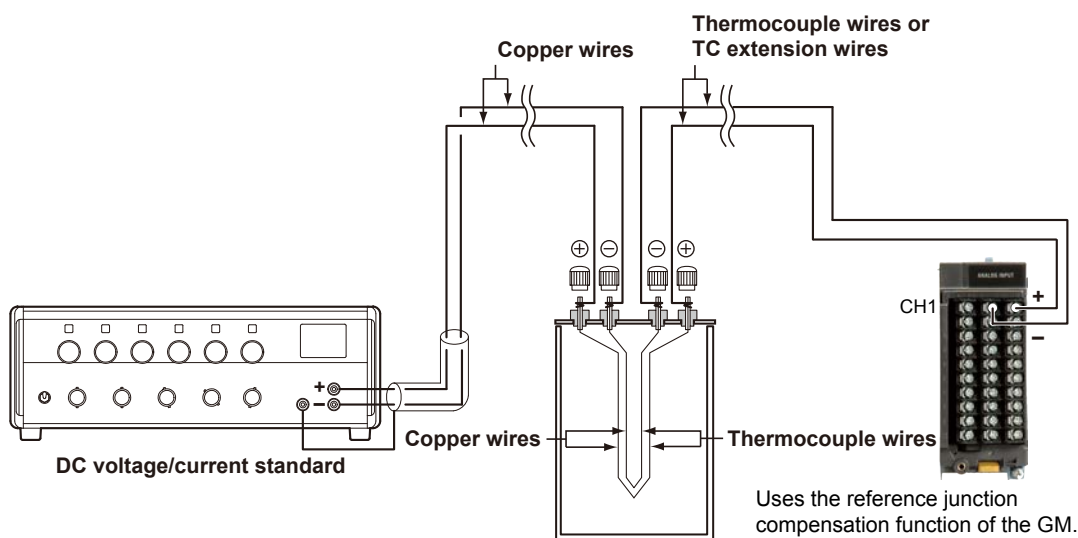

(0°C standard temperature device ZC-114/ZA-10 by Coper Electronics)

RJC of TC Input

As the measurement terminal of the GM is generally at room temperature, the actual output of the thermocouple is different from the values given on the thermoelectromotive force table based on 0°C. The GM performs compensation by measuring the temperature at the input terminal and adding the corresponding thermoelectromotive force to the actual output of the thermocouple. Therefore, when the measurement terminal is shorted (equivalent to the case when the detector tip is 0°C), the measured value indicates the temperature of the input terminal.

When calibrating the GM, this compensation voltage (thermoelectromotive force of 0°C reference corresponding to the input terminal temperature) must be subtracted from the output of the standard generator before application. As shown in the figure, by using the 0°C standard temperature device to compensate the reference junction at 0°C, you can input the thermoelectromotive force of 0°C reference from the DC voltage standard and perform the calibration.

Calibrating AO Modules

Required Instruments

To adjust AO modules, you need calibration instruments with the following specifications and accuracy.

Recommended Instruments

- Resistance standard: Accuracy: $\pm 0.01\%$ or more
 Allowable power: 0.25 W or higher
 Temperature coefficient: 5ppm/ $^{\circ}\text{C}$ or less
 Resistance value: 600 Ω or less
- Digital Multimeter: Accuracy: $\pm 0.01\%$ or more

For information on purchasing these calibration instruments, contact your nearest YOKOGAWA dealer.

Calibration Procedure

- 1** Wire the GM and the calibration instruments as shown in the following figure, and adequately warm up the instruments (the warm-up time of the GM is at least 30 minutes).
- 2** Check that the operating environment such as ambient temperature and humidity is within the standard operating conditions (see "General Specifications").
- 3** Set the range type to **Manual** and the range to **4-20mA**.
- 4** Manually output 4 mA and 20 mA, and determine the error from the measured values. For measurements using voltage, the error is determined from the difference between the measured value and the digital multimeter value. If the error does not fall within the accuracy range of the specifications, servicing is required. Contact your nearest YOKOGAWA dealer.

Operation complete

Voltage measurement wiring

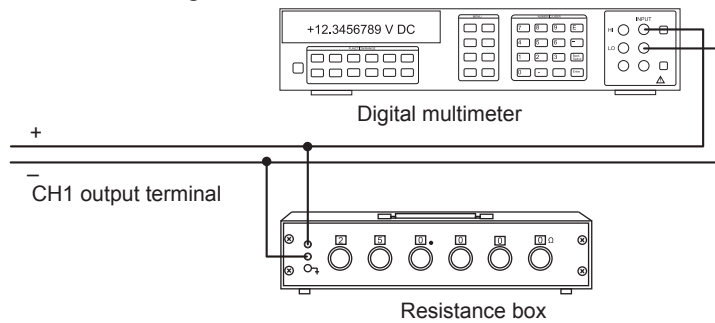

Current measurement wiring

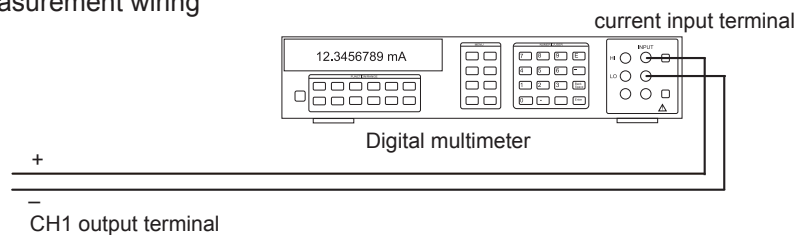

Calibrating PID Control Modules

For input calibration, refer to the AI module calibration. For output calibration, refer to the AO module calibration.

For details on wiring, see "Installation and Wiring" in the First Step Guide (IM 04L55B01-02EN).

5.1.3 Performing A/D Calibration and Adjusting the Input Accuracy of an AI Module

Preparing the Instruments

- 1** Wire the GM and the calibration instruments as shown in the following figure, and adequately warm up the instruments (the warm-up time of the GM is at least 30 minutes).
For details on wiring, see "Installation and Wiring" in the First Step Guide (IM 04L55B01-02EN).
- 2** Check that the operating environment such as ambient temperature and humidity is within the standard operating conditions (see "General Specifications").

Operation complete

Universal, Electromagnetic Relay, Low Withstand Voltage Relay, Current (mA), 4-wire RTD/Resistor, High Withstand Voltage Type

Wiring for DC voltage range

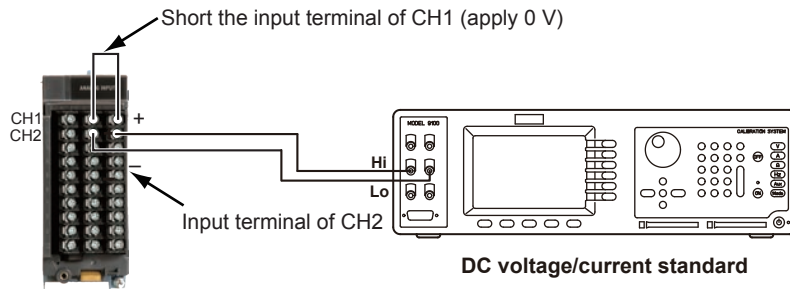

Wiring for RTD range

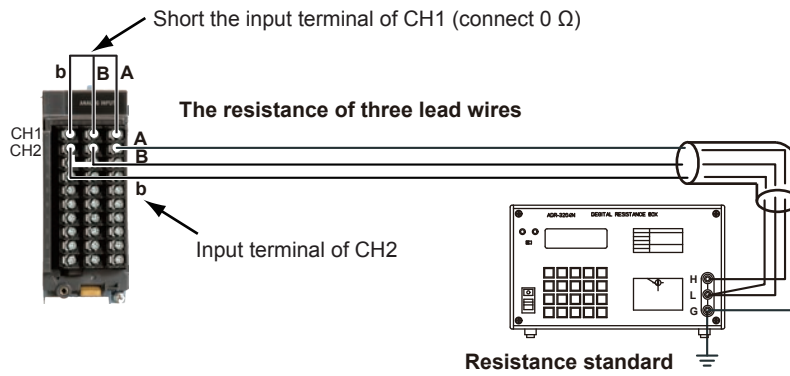

Wiring Current (mA) Input Modules

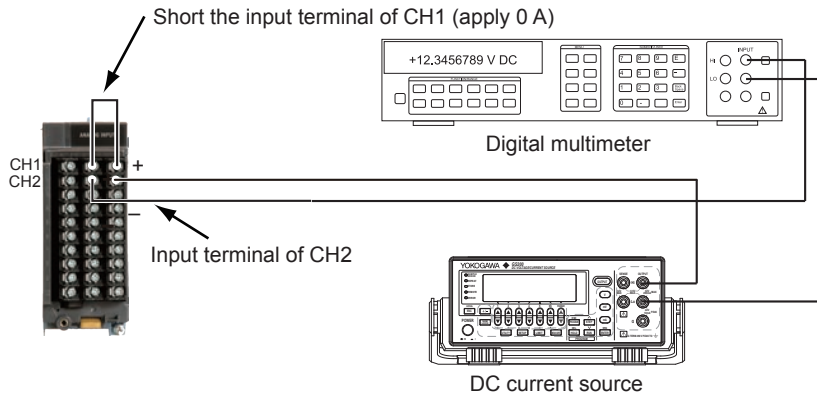

High-speed Universal Type

Wiring for DC voltage range

Wiring for zero-point calibration

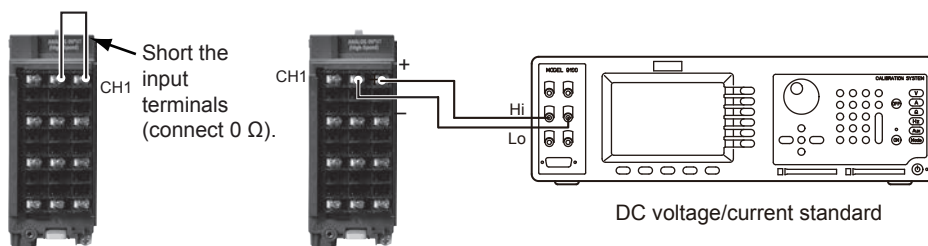

Wiring for RTD range

Wiring for zero-point calibration

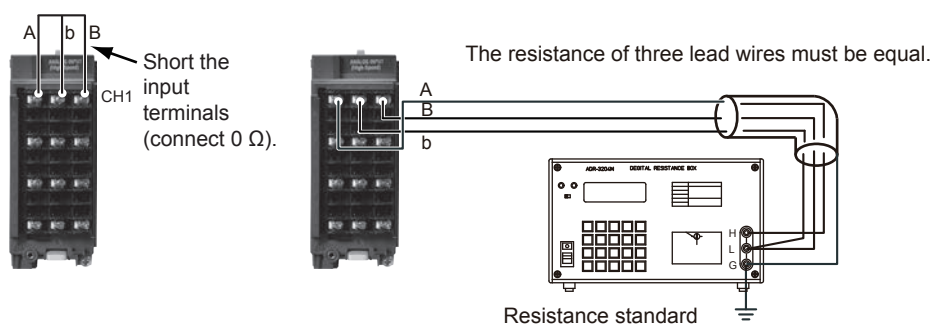

4-wire RTD/Resistor Type

The resistance of four lead wires must be equal.

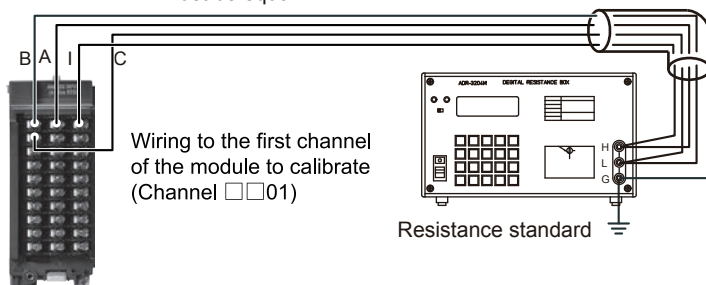

Performing A/D Calibration and Adjusting the Input Accuracy

Adjustment is performed from the Web application. You cannot perform A/D calibration while recording or computation is in progress. A/D calibration is performed in A/D calibration mode. For details on switching to the A/D calibration mode when you are using the advanced security function (/AS option), see section 2.2.1, "Logging In," in the Advanced Security Function (/AS) User's Manual (IM 04L55B01-05EN).

Note

- When switching to A/D calibration mode, the GM restarts. When this happens, if the GM is configured to obtain the IP address automatically, the IP address may change after restarting, preventing the Web application from connecting to the GM.
- We recommend that you use a fixed IP address for A/D calibration. If you cannot use a fixed IP address, change the GM to Fixed IP address mode using the GM10 keys.
- Switching to A/D calibration mode is not possible with a User connection.

Switching to Fixed IP Address Mode

1. While holding down **USER1**, turn the power on.
The 7 segment LED displays "C0."
2. Press **STOP**.
The 7 segment LED display changes from "C0" to the system number indication.
 - Fixed IP address: 192.168.1.1
 - ▶ See page 1-70 in section 1.7.4, "Operation Mode"
 - To return to normal mode, turn the GM off and then back on (restart).

Adjusting the Input Accuracy

Universal, Electromagnetic Relay, Low Withstand Voltage Relay, Current (mA) Input, High Withstand Voltage Type

- 1 Click the **Config.** tab and then **A/D calibration**.
A screen appears for you to confirm the switch to A/D calibration mode.
- 2 Click **Next**.
A Mode Switching dialog box appears.
- 3 Click **OK**.
The GM restarts in A/D calibration mode.
Detected analog input modules (module list) are displayed in the left side of the content area. If they do not appear, analog input modules have not been detected.

Reload modules
Reloads and displays linked modules

Execute
Calibrates the selected range

End
Returns to normal mode

Write
Writes (saves) calibration values

RESET
Returns the calibration values to their factory defaults

Password settings
Displays a dialog box for setting a password

Module list

Selected module

Range	Value1	Value2	A/D calibration
20mV	1.2499	-0.0003	Execute
60mV	1.2496	-0.0001	Execute
200mV	1.2496	0.0000	Execute
1V	1.2498	0.0000	Execute
2V	1.2504	0.0000	Execute
6V	1.2503	0.0000	Execute
20V	1.2504	0.0000	Execute
50V	1.2503	0.0000	Execute
Pt100-H	2.1998	0.9996	Execute
Pt100	2.2000	0.9999	Execute

In A/D calibration mode, the GM10's 7 segment LED shows "A2."

- 4** From the module list, select the module you want to calibrate.
A calibration table for the selected module appears.
- 5** For each calibration range, enter the reference values according to the table below.

Universal, Electromagnetic Relay, Low Withstand Voltage Relay, Current (mA) Input, High Withstand Voltage Type

Range	CH1	CH2
20 mV	0 mV (short)	20 mV
60 mV	0 mV (short)	60 mV
200 mV	0 mV (short)	200 mV
1 V	0 V (short)	1 V
2 V	0 V (short)	2 V
6 V	0 V (short)	6 V
20 V	0 V (short)	20 V
50 V	0 V (short)	50 V
Pt100-H ¹	0 Ω (short)	160 Ω
Pt100 ¹	0 Ω (short)	400 Ω
20 mA ²	0 A (short)	20 mA

- 1 Range calibration of RTDs is not applicable to the electromagnetic relay type (Type suffix code -T1), low withstand voltage relay type (Type suffix code -L1) or high withstand voltage type (Type suffix code -V1) analog input module.
- 2 For only the analog input modules of the current input type (Type suffix code -C1)

4-wire RTD/Resistor Type

Range	CH1	CH2
Pt100-H	0 Ω (short)	160Ω
Pt100	0 Ω (short)	400Ω
Pt1000	0 Ω (short)	4000Ω
20Ω	0 Ω (short)	20Ω
2000Ω	0 Ω (short)	2000Ω

- 6** Click **Execute**.
Calibration takes up to 20 seconds to complete. If calibration is successful, Value1 and Value2 values change to blue (light blue).
- 7** Repeat step 5 for every range.
- 8** When all the ranges have been calibrated, click **Write**.
The calibration values will be saved.
- To reset the A/D calibration values to their factory defaults, click **Reset**.
You do not have to click **Write**.
- 10** To calibrate another module, wire the module you want to calibrate, and perform steps 4 to 6.
- 11** To return from A/D calibration mode to normal mode, click **End**.
When a dialog box appears, click **OK**.
The GM restarts in normal mode.

Operation complete

High-speed Universal Type

- 1** Click the **Config.** tab and then **A/D calibration.**
A screen appears for you to confirm the switch to A/D calibration mode.
- 2** Click **Next.**
A Mode Switching dialog box appears.
- 3** Click **OK.**
The GM restarts in A/D calibration mode.

In A/D calibration mode, the GM10's 7 segment LED shows "A2."

- 4** From the module list, select the module you want to calibrate.
A channel selection for the selected module appears.
- 5** Select the channel you want to calibrate.
A calibration table for the selected module appears.
- 6** Short the input terminals of the channel to you want to calibrate.
- 7** Click **Execute** under Zero for the range you want to calibrate.
Calibration takes up to 20 seconds to complete.
- 8** Enter the reference value of the range to be calibrated according to the following table, and click **Execute** under Full.
If calibration is successful, Value1 and Value2 values change to blue (light blue).

Range	Reference value
20 mV	20 mV
60 mV	60 mV
200 mV	200 mV
1 V	1 V
2 V	2 V
6 V	6 V
20 V	20 V
50 V	50 V
100 V	100 V
Pt100-H	160 Ω
Pt100	500 Ω
Cu10 GE	50 Ω

- 9** For each range you want to calibrate, repeat steps 7 and 8.
- 10** When all the ranges have been calibrated, click **Write.**
The calibration values will be saved.
- 11** Click **Go back** to return to channel selection. To calibrate other channels, select the channel you want to calibrate, and repeat steps 6 to 10.
- 12** To return from A/D calibration mode to normal mode, click **End.**
When a dialog box appears, click **OK.**
The GM restarts in normal mode.

Operation complete

Note

- Do not perform any other operations (especially turning the GM off) during calibration.
The GM may malfunction.

If you perform any of the following operations, a special standby screen for A/D calibration mode will appear with message M8204 (see page 5-20 in section 5.2.1, "Messages").

- If you press Refresh on the Web browser in A/D calibration mode
- If a connection is made to the GM10 in A/D calibration mode
- While using the Web application, the mode is changed to A/D calibration mode from a Web application of another Web browser.

.....

5.1.4 Calibrating the D/A of AO Modules and Adjusting the Output Accuracy

Required Instruments and Preparation

- ▶ See page 5-4 in section , “Calibrating AO Modules”.

Switching to Fixed IP Address Mode

1. While holding down **USER1**, turn the power on.
The 7 segment LED displays “C0.”
2. Press **STOP**.
The 7 segment LED display changes from “C0” to the system number indication.
 - Fixed IP address: 192.168.1.1
 - ▶ See page 1-70 in section 1.7.4, “Operation Mode”.
 - To return to normal mode, turn the GM off and then back on (restart).

Adjusting the Output Accuracy

- 1 Click the **Config.** tab and then **A/D calibration**.
A screen appears for you to confirm the switch to A/D calibration mode.
- 2 Click **Next**.
A Mode Switching dialog box appears.
- 3 Click **OK**.
The GM restarts in A/D calibration mode.
Detected AO modules (module list) are displayed in the left side of the content area. If they do not appear, the modules have not been detected.

The screenshot shows the 'A/D Calibration Mode' interface. On the left, there is a 'Module list' with a 'Selected module' highlighted. The main area displays four calibration tables, one for each channel (001 to 004). Each table has columns for '4mA', 'Count', 'Edit', and 'Output'. The 'Output' column contains 'START' buttons. At the bottom, there are buttons for 'Password settings', 'RESET', 'Write', and 'End'. Red arrows point from these buttons to descriptive text labels on the right side of the image.

Channel	4mA	Count	Edit	Output
Channel 0001	4mA	8017	Edit	START
	20mA	42151	Edit	START
Channel 0002	4mA	8637	Edit	START
	20mA	42185	Edit	START
Channel 0003	4mA	8963	Edit	START
	20mA	42237	Edit	START
Channel 0004	4mA	8843	Edit	START
	20mA	42204	Edit	START

Reloads modules
Reloads and displays linked modules

Start/Stop
Starts or stops the output of the selected range

Edit
Writes calibration values

Set the password.
Displays a dialog box for setting a password

Module list

Selected module

End
Returns to normal mode

Write
Saves calibration values

Reset
Returns the calibration values to their factory defaults

In A/D calibration mode, the GM10's 7 segment LED shows “A2.”

- 4 From the module list, click the module you want to calibrate.
A calibration table for the selected module appears.

5 Click **START** for the 4 mA range of the channel to be calibrated. The GM outputs at the current calibration value. During output, the button changes to STOP. Output can be started simultaneously on multiple channels of the same module.

6 Click **Edit** for the calibration value (Count). A counter value edit dialog box appears.

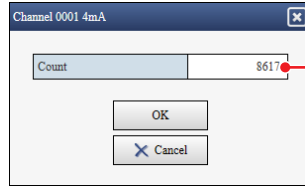

Set the calibration value.

7 Set the calibration value, and click **OK**. The specified calibration value is written, and the corresponding value is output. Repeat the procedure until the multimeter reading falls within the values corresponding to the output accuracy.

Example of the accuracy range for voltage measurement (voltage drop method, resistance: 250 Ω)

Range	Output accuracy range	Digital multimeter indication range (Resistance: 250 Ω)
4 mA	3.98 to 4.02 mA	995 mV to 1005 mV
20 mA	19.98 to 20.02 mA	4995 mV to 5005 mV

8 Perform a procedure similar to steps 5 to 8 to calibrate the 20 mA range.

9 To calibrate another channel, wire the channel you want to calibrate, and perform steps 5 to 8.

10 When all the channels have been calibrated, Click **Save**. The calibration values are saved.

To reset the calibration values to their factory defaults, click **Reset**. You do not have to click **Save**.

11 Click **End** to display a confirmation screen. Click **OK** to end A/D calibration mode.

Operation complete

5.1.5 Calibrating the I/O of PID Modules and Adjusting the I/O Accuracy

Calibrating the Input

- 1** Click the **Config.** tab and then **A/D calibration.**
A screen appears for you to confirm the switch to A/D calibration mode.
- 2** Click **Next.**
A Mode Switching dialog box appears.
- 3** Click **OK.**
The GM restarts in A/D calibration mode.
In A/D calibration mode, the GM10's 7 segment LED shows "A2."
- 4** From the module list, select the module you want to calibrate.
An input/output selection for the selected module appears.
- 5** Click **Input calibration.**
A channel selection screen appears.
- 6** Select the channel you want to calibrate.
A calibration table for the selected module appears.
- 7** Short the input terminals of the channel to you want to calibrate.
- 8** Click **Execute** under Zero for the range you want to calibrate.
Calibration takes up to 20 seconds to complete.
- 9** Enter the reference value of the range to be calibrated according to the following table, and click **Execute** under Full.
If calibration is successful, Value1 and Value2 values change to blue (light blue).

Range	Reference value
20 mV	20 mV
60 mV	60 mV
200 mV	200 mV
1 V	1 V
2 V	2 V
6 V	6 V
20 V	20 V
50 V	50 V
Pt100-H	160 Ω
Pt100	500 Ω
Cu10 GE	50 Ω

- 10** For each range you want to calibrate, repeat steps 7 and 8.
- 11** When all the ranges have been calibrated, click **Write.**
The calibration values will be saved.
- 12** Click **Go back** to return to channel selection. To calibrate other channels, select the channel you want to calibrate, and repeat steps 6 to 11.
- 11** To return from A/D calibration mode to normal mode, click **End.**
When a dialog box appears, click **OK.**
The GM restarts in normal mode.

Operation complete

Adjusting the Output Accuracy

- 1** Select the **Config.** tab and then **A/D calibration.**
A screen appears for you to confirm the switch to A/D calibration mode.
- 2** Select **Next.**
A Mode Switching dialog box appears.
- 3** Select **OK.**
The GM restarts in A/D calibration mode.
- 4** From the module list, select the module you want to calibrate.
An input/output selection for the selected module appears.
- 5** Click **Output calibration.**
A channel selection screen appears.
- 6** Select the channel you want to calibrate.
A calibration table for the selected module appears.
- 7** Select **START** for the 4 mA range of the channel to be calibrated.
The GM outputs at the current calibration value. During output, the button changes to **STOP**.
Output can be started simultaneously on multiple channels of the same module.
- 8** Select **Edit** for the calibration value (Count).
A counter value edit dialog box appears.
- 9** Set the calibration value, and select **OK.**
The specified calibration value is written, and the corresponding value is output.
Repeat the procedure until the multimeter reading falls within the values corresponding to the output accuracy.

Example of the accuracy range for voltage measurement (voltage drop method, resistance: 250 Ω)

Range	Output Accuracy Range	Digital Multimeter Indication Range (Resistance: 250 Ω)
4 mA	3.98 to 4.02 mA	995 mV to 1005 mV
20 mA	19.98 to 20.02 mA	4995 mV to 5005 mV

- 10** Perform a procedure similar to steps 6 to 8 to calibrate the 20 mA range.
- 11** To calibrate another channel, wire the channel you want to calibrate, and perform steps 5 to 8.
- 12** When all the channels have been calibrated, Click **Save.**
The calibration values are saved.

To reset the calibration values to their factory defaults, click **Reset.**
You do not have to click **Save.**
- 13** Select **End** to display a confirmation screen. Select **OK** to end A/D calibration mode.

Operation complete

5.1.6 Using a Password

You can use a password to allow only permitted users to perform calibration. This is not available when you are using the advanced security function (/AS option) and Communication of the security function is set to Login.

- 1** Switch A/D calibration mode, and click **Password settings**.
An A/D calibration Password dialog box appears.
- 2** Click **On** under On/Off.
- 3** Enter the same password in the **New Password** and **New Password Again** boxes.
You will need to enter the password the next time the GM is switched to A/D calibration mode.

Operation complete

Note

Initialization does not initialize the A/D calibration password.
If you forget the password, you will not be able to perform A/D calibration. Make sure you do not forget the password.

5.1.7 Recommended Replacement Periods for Worn Parts

To ensure that this instrument operates reliably and correctly for a long time, we recommend that you carry out preventative maintenance by periodically replacing its parts. As you continue to perform this preventative maintenance over time, the parts that need to be replaced may change. Be sure to check with your nearest YOKOGAWA dealer for information on part replacement.

The recommended replacement periods for parts that wear down (parts that have a service life) are shown in the following table.

The replacement periods listed here have been calculated under the assumption that the GM is used under standard operating conditions. Use these values as a guideline when you determine the replacement periods of the parts of your GM based on its actual usage conditions. Parts must be replaced by qualified YOKOGAWA technicians or technicians specified by YOKOGAWA, so contact your YOKOGAWA dealer when part replacement is necessary.

Item	Replacement Period	Model	Name	Part No.	Quantity	Notes
Battery	10 years	GM10	Battery Assembly	B8800ZK	1	

* Replacement period when the GM is used at the upper limit of the normal operating temperature (50°C)

The replacement period for aluminum electrolytic capacitors varies depending on the operating temperature and the GM specifications. When the operating temperature is 30°C, the replacement period may be 10 years or more.

Module

Electromagnetic relay type modules make measurements by switching mechanical contact relays on and off. To ensure that the modules continue to operate reliably and correctly, replace them periodically as shown below.

Module	Model	Measurement Condition	Replacement Period	Notes
Analog input module (electromagnetic relay type)	GX90XA-10-T1N-3N	Continuous use at 1 s scan interval	1 years	
		Continuous use at 2 s scan interval	2 years	
		Continuous use at 5 s scan interval	5 years	

The power supply module uses aluminum electrolytic capacitors. To ensure that the modules continue to operate reliably and correctly, replace them periodically as shown below.

Module	Model	Replacement Period	Notes
Power supply module	GM90PS	5 years*	

- * Replacement period when the GM is used at the upper limit of the normal operating temperature (60 °C)
When the operating temperature is 30°C, the replacement period may be 10 years or more.

5.1.8 Updating the Firmware

This section explains how to update the firmware of the Web application, I/O module I/O expansion module (expansion module), and network module. Updating is performed in update mode. You need to place the new files in the SD card in advance. You cannot update while recording or math is in progress.

You can download firmware from the following URL.

www.smartdacplus.com/software/en/

Data Files Applicable for Updating

Target	Description
Web application	Web application
I/O expansion module	I/O expansion module firmware
I/O module (AI/DI/DO/DIO)	I/O module firmware
Pulse input module	Pulse input module firmware
AO module ¹	AO module firmware
High-speed AI module ¹	High-speed AI module firmware
4-wire RTD/resistor module ¹	4-wire RTD/resistor module firmware
PID control module ¹	PID control module firmware
Network module ²	Network module firmware

¹ Release number 4 and later

² Release number 5.02 and later

Switching to Update Mode

Note

- When switching to update mode, the GM restarts. When this happens, if the GM is configured to obtain the IP address automatically, the IP address may change after restarting, preventing the Web application from connecting to the GM.
- We recommend that you use a fixed IP address to update the firmware. If you cannot use a fixed IP address, change the GM to Fixed IP address mode using the GM10 keys (see “Switching to Fixed IP Address Mode” on page 5-8).
- Switching to update mode is not possible with a User connection.

1 Click the **Config.** tab and then **Update**.
A screen appears for you to confirm the switch to update mode.

2 Click **Next**.
A Mode Switching dialog box appears.

3 Click **OK**.
The GM restarts in update mode.
An update list appears on the left side of the content list.
In update mode, the GM10's 7 segment LED shows “A7.”

Operation complete

Note

If you perform any of the following operations, a special standby screen for update mode will appear with message M8203 (see page 5-20 in section 5.2.1, “Messages”).

- If you press Refresh on the Web browser in update mode
- If a connection is made to the GM10 in update mode
- While using the Web application, the mode is changed to update mode from a Web application of another Web browser

Updating the Web Application

- 1** In **Update mode** of the content area, select **GM10**.
- 2** Click **Next**.
An Update (Web application) dialog box appears.
The current version and the new version after updating are displayed.
- 3** Click **Update**.
Updating will take place.
When the process is complete, the Update dialog box appears.
- 4** Click **OK**.
- 5** To return to normal mode, click **End**.
When a dialog box appears, click **OK**.
The GM restarts in normal mode.

Operation complete

Note //

When you return to normal mode after updating the Web application, the content area displays the instruction "Please delete temporary internet files from the browser, close the browser and restart the application" appears.

To execute this instruction, perform the following procedure.

- 1 Delete the temporary Internet files.
- 2 Close your browser once. If you do not close it and refresh the browser, the files may not be deleted properly.
- 3 Start your browser and connect to the GM. The update Web application will run.

Updating Modules

Note //

Do not perform any other operations (especially turning the GM off) during updating.
The module may malfunction, or the Web application may fail to run properly.

Collectively Updating

- 1** In **Update mode** of the content area, select **Module**.
- 2** Click **Batch update** under **All modules**.
The module firmware is updated.
- 3** Click **Next**.
The **Update (All modules)** dialog box appears.
The current version and the new version after updating are displayed.
- 3** Click **Update**.
Updating will take place.
When the process is complete, the Update dialog box appears.
- 4** Click **OK**.
- 5** To return to normal mode, click **End**.
When a dialog box appears, click **OK**.
The GM restarts in normal mode.

Operation complete

Note

If the main unit's expansion module version is earlier than R1.02.01, update to R1.02.01 or later before using batch update.

Updating Individually

- 1** In **Update mode** of the content area, select **Module**.
- 2** Click the module you want to update.
- 3** Click **Next**.
The **Update** dialog box appears.
The current version and the new version after updating are displayed.

The title of the dialog box will show the model of the selected module.
- 3** Click **Update**.
Updating will take place.
When the process is complete, the Update dialog box appears.
- 4** Click **OK**.
- 5** To return to normal mode, click **End**.
When a dialog box appears, click **OK**.
The GM restarts in normal mode.

Operation complete

5.2 Troubleshooting

5.2.1 Messages

Error codes may appear on the 7 segment LED or Web application screen or in the error log while you are using the GM. On the GM, an error code is displayed with an alternating pattern: first the error type* and the hundreds digit of the error number and then the lower two digits (the tens and ones digits) of the error number. A list of the possible error codes and messages are given in the table below. Communication error codes and messages are also listed.

Error responses to communication commands are output in English.

* There are two error types: normal errors and system errors. Normal errors are indicated with an E and system errors with an F. Normal errors include execution errors and operation errors related to parameter settings and communication application errors.

Note

- The 7 segment LED displays only the latest error code. Error codes that occurred in the past are cleared.
- When an F type error code is displayed, E type error codes do not appear.
- You can clear an error code displayed on the 7 segment LED by pressing STOP. But, F type error codes cannot be cleared.

Errors Related to Parameter Settings

• Setting Errors

Code	Description	Description, Corrective Action, Ref. Section
1	Incorrect date or time setting.	Enter a correct value.
2	The setting of the parameter is wrong. Please confirm specifications.	Check the communication command specifications.
3	The input numerical value exceeds the set range.	Enter a proper value.
4	Incorrect input character string.	Enter a proper character string.
5	Too many characters.	Enter the correct number of characters.
6	The format of the parameter is wrong.	Check the communication command specifications.
9	String's length has exceeded.	Enter the correct number of characters.
11	The module does not exist.	Check that the module is installed correctly.
12	No specified input channel.	Specify a channel that is installed.
13	Exceeded the number of channels which can be set.	Set the correct number of channels.
14	The same channel exist more than one.	Set a channel only once.
15	The specified number is set to manual.	Set the DO channel or internal switch Type to Alarm .
16	Please specify at least one channel.	Specify a channel.
31	Invalid input value. (in ascending order)	Set the calibration correction value to a value greater than the previous value.
41	No channel specified by formula.	Check the channel number specified by the expression.
42	MATH expression grammar is incorrect.	Check that the expression grammar is correct.
43	Invalid order of operators.	Check that the operator used in the expression in relation to the applicable operands meets the grammar requirements.
44	Too many operators for MATH expression.	The maximum number of operators in an expression has been exceeded. Reduce the number of operators, such as by splitting up the expression into multiple math channels.
45	Nonexistent constant specified in MATH expression.	Check the constant number specified by the expression.
46	The scale band is wider than 16 decades of the entire scale.	Set the scale width to 15 decades or less. (See the Log Scale (LG) User's Manual.)
47	The scale band is less than 1 decades of the entire scale.	Set the scale width to 1 decades or more. (See the Log Scale (LG) User's Manual.)
48	The combination of mantissa and index is wrong.	Set the mantissa and exponent properly. (See the Log Scale (LG) User's Manual.)
49	Invalid operator or operand used.	Check that the expression grammar is correct.
91	This username is already registered.	Register another user name.
92	'quit' string cannot be specified.	Change the character string.
93	String including space cannot be specified.	Change the character string.
94	NULL cannot be specified.	Change the character string.
95	User ID already registered.	

Continued on next page

Code	Message	Description, Corrective Action, Ref. Section
96	This user name cannot be specified.	Change the character string.
101	Duplicated port number.	Enter a different port number for each function.
102	IP address class error.	Check the IP address.
103	Masked IP address is all 0s or 1s.	Check the subnet mask.
104	SUBNET mask is incorrect.	Check the subnet mask.
105	The net part of default gateway is not equal to that of IP address.	Check the IP address.
106	More than one address cannot be specified.	Only a single sender is allowed.
107	Number entered exceeds channel number range. Use another command.	Check the syntax of the Modbus command.
108	The network part of the IP address is not the same as that of the main IP address.	Check the IP address.
109	The set IP address is the same as that of the main unit or the default gateway.	Check the IP address.
141	Duplicated loop number.	Set them so that they are not overlapped.
142	Exceeded maximum PID group number.	
143	Invalid loop number.	Enter the correct loop number.

• Execution Errors

Code	Message	Description, Corrective Action, Ref. Section
201	Cannot execute because other users changed setting.	Perform the operation again.
202	This action is not possible because recording or math computation is in progress.	Execute after stopping recording or computing.
203	This action is not possible because sampling is in progress.	Execute after stopping recording.
204	This action is not possible because math computation is in progress.	Execute after stopping computing.
208	Control is in progress.	Stop all control loops. Stop all control loops.
209	This action is not possible because recording or control is in progress.	
210	This action is not possible because control is in progress.	Stop all control loops.
211	This function is not possible now.	Check the GM status, and then execute again.
213	This function is not available with invalid user.	
214	This function is not available with logged out user.	Log in and perform the operation.
215	File is not loaded.	Load the early warning detection model or profile waveform.
216	Failed to load model. Serial number not matched.	The serial number of the target device written to the early warning detection model does not match the serial number of the GM.
221	This function is not possible because input number is over.	The limit is 50 messages (10 for free messages).
222	Failed to write while recording stopped.	Execute after starting recording.
224	Failed to write message to outside of data range.	Move within the data range.
225	Failed to print.	Check the printer and network status.
231	This action is not possible because saving is in progress.	Wait until saving is complete.
233	Data save is not possible because of insufficient media capacity.	Replace the external storage medium.
234	Invalid file or directory name.	Use alphanumeric characters and symbols.
235	This action is not possible because FTP transmission is in progress.	Execute after FTP data transfer is complete.
242	End process can't proceed, because setting file is not saved to Media	Change the storage medium.
243	Exceeded max number of change.	Reduce the number below the maximum number of settings that can be changed.
244	Configuration error.	Failed to change settings, initialize, or reconfigure. Execute the operation again. (An error occurs if the power is interrupted while the operation is in progress.)
245	Execution error, lack of key.	Set the encryption function to On in the Encryption/Certificate screen of Init/Calib, and then create a key.
246	Failed to process input value.	Check that the module is installed correctly.
251	Invalid user name or password.	Enter the correct name or password.
252	The login password is incorrect.	Check the password. If the password is lost, the password must be initialized by an administrator.
253	A user already logged in.	There is a user already logged in with the same name or started the login operation.

Continued on next page

5.2 Troubleshooting

Code	Message	Description, Corrective Action, Ref. Section
254	This entry is incorrect.	The maximum number of login users has been exceeded.
255	Password entered is incorrect.	Enter the correct password.
256	Same password not allowed.	Specify a different password.
257	Password is incorrect.	Enter the correct password.
258	This function is locked.	Log in using a user account that has permission to use the operation.
260	This user name is unable to use this mode.	Users cannot switch modes.
261	Wrong user ID or password.	Enter the correct user ID and password.
262	Log in failed, password expired.	Change the password.
263	No change for default password.	Set a password that is different from the default password.
264	This user ID and password combination is already in use.	Set them so that they are not overlapped.
265	Login inputs are incorrect.	Enter the correct login information.
266	Incorrect Bluetooth password.	Enter the correct password.
272	This password became invalid.	On the GM, because the wrong password has been entered consecutively for more than the permissible number of times, this user has been locked out.
273	Invalid user.	The account has been invalidated on the server. The account has been invalidated on the GM.
274	Please enter more than 6 characters.	The account has been invalidated on the server. The account has been invalidated on the GM.
281	Exceeds time deviation setting.	The time change made during recording exceeds the time deviation limit. Set the time within the Time deviation limit, which is set in Time basic settings of System settings. ►page 2-182 in section 2.26.4, "Setting the Time Zone, Gradual Time Adjustment, and Daylight Saving Time"
301	No modules to download the firmware.	Do not remove the module while firmware is being downloaded.
302	Firmware file not found.	Check that the firmware file exists on the specified medium.
303	Failed to read firmware file.	Download the firmware again. Check that the SD card is not damaged and that it is not disconnected while the firmware is being downloaded.
304	Corrupted firmware file.	Download the appropriate firmware from our Website.
305	Invalid firmware version.	Download the appropriate firmware from our Website.
306	Mismatch module type.	Download the appropriate firmware for the module type that you want to update from our Website.
307	Firmware download error.	Download the firmware again. Check that the SD card is not damaged and that it is not disconnected while the firmware is being downloaded.
321	Cannot operate specified loop.	Perform the operation on the correct loop number.
322	Invalid control parameter.	Enter a valid value less than the high limit.
323	Cannot operate in this control mode.	Check the control mode setting.
324	Auto-tuning in progress.	Wait for auto-tuning to complete, and then perform the operation again.
325	Auto-tuning failed.	Check the process.
326	Cannot operate in this control condition.	Check the control status.
327	Cannot operate in this control settings. Check the control status.	
331	Cannot change program mode.	Check the pattern settings and control status.
332	Specified pattern number does not exist.	Perform the operation on the correct pattern number.
333	Failed to open the program pattern file.	Load or create a pattern file.
334	Program operation already started.	
335	Program operation not started.	
336	Specified pattern number is not in program operation.	Select a pattern number that is running.
337	Cannot change current segment settings.	

Continued on next page

Code	Message	Description, Corrective Action, Ref. Section
338	Program is not in hold operation.	
339	Invalid program pattern file.	Check that the module is installed correctly.
341	Exceed PV range setting.	Check the PV range setting on the main unit and the pattern file.
403	Input Bluetooth password.	Enter the correct password.

• Operation Errors

Code	Message	Description, Corrective Action, Ref. Section
501	Operation aborted due to media error.	Change the storage medium.
502	Not enough free space on media.	Not enough free space on the storage medium, or the limit of the number of directories has been exceeded. Change the storage medium.
503	Media not recognized.	Remove the storage medium, and set it again. For the advanced security function (Option / AS), the setting change history is recorded in the event log, and the changed setting file is saved on the SD memory card. To change the setting, an SD memory card must be inserted.
504	Media read error.	Change the storage medium.
505	Media write error.	
506	Failed to create the file.	
507	No file or directory.	Tried to access a file which does not exist in the internal memory.
509	Unknown file type.	Check the extension.
511	Invalid file or directory operation.	Tried to delete a directory containing files. Delete the files and directories in the directory first before executing the operation.
512	The file is already in use. Try again later.	Wait until the file becomes accessible.
514	No setting files.	Check the setting parameter file.
515	A template file is abnormal.	Check the report template file.
516	Some items not set.	Check the error log.
517	Media is read-only.	Make it writable.
519	Template file not loaded.	Load a template file.
532	No data available.	This error occurs when there is no valid data in the internal memory. Specify valid data.
541	Printer not connected.	Check the printer settings. Check the printer and network conditions.
542	Printer busy.	Execute after printing is complete.
551	Module was detached.	Check that the module is installed correctly.
552	Detected newer version module.	Check the module version.
553	Unrecognized module.	Check that the module is installed correctly.
554	Fatal module error.	If the same message continues to appear even after you perform the procedure above, servicing is required. Contact your nearest YOKOGAWA dealer for repairs.
555	Non-calibrated module.	Perform A/D calibration.
556	RJC error module.	Servicing is required. Contact your nearest YOKOGAWA dealer for repairs.
557	A/D error module.	
558	Activation required for attached modules.	Activate modules.
559	Installed modules require update.	Check that the IO module version is R1.04.01 or later and that the expansion module version is R1.02.01 or later.
560	Module connection error. System stopped.	Check that modules are not linked in a way that would cause the system to shut down.
561	Module was detached. Please readjust reminder settings.	Check that the module is installed correctly.
562	Detected pulse counter error modules.	If the same message continues to appear even after you perform the procedure above, servicing is required. Contact your nearest YOKOGAWA dealer for repairs.
570	The specified file does not exist.	Specify a valid file name.
571	The specified folder does not exist.	Check the folder name.
572	Deletion of the file went wrong.	Change the storage medium.
573	Deletion of the folder went wrong.	Change the storage medium.

Continued on next page

5.2 Troubleshooting

Code	Message	Description, Corrective Action, Ref. Section
611	System rebooted due to FPGA software error.	An FPGA (Field Programmable Gate Array) software error or device error was detected. To prevent erroneous operation, the system was restarted. If the system does not recover, contact your nearest YOKOGAWA dealer. ▶ Section 5.2.3, "Auto Restart When a Device Error Occurs (Release number 4 (version 4.04) and later)" on page 5-48
612	System rebooted due to CPU error.	A device error was detected, and the system was automatically restarted to prevent erroneous operation. If the system does not recover, contact your nearest YOKOGAWA dealer. ▶ Section 5.2.3, "Auto Restart When a Device Error Occurs (Release number 4 (version 4.04) and later)" on page 5-48
632	Failed to calculate the health score. Insufficient data.	Insufficient number of recorded data points to calculate the score. Use 2 or more recording data points.
633	Failed to calculate the health score.	Some or all of the target channels in the predictive detection model are not enabled. A power outage occurred in the middle of the early warning detection interval.
634	The target channels for predictive detection are invalid.	Some or all of the target channels in the predictive detection model are not enabled. Confirm that the target channel of the predictive detection model is not Skip or Off . Confirm that the target channel of the predictive detection model is set to the recording channel.

Communication Application Errors

• Errors Related to E-mail

Further details are provided by the character string (detail code) that appears after code.

Code	Message	Character String	Description, Corrective Action, Ref. Section
651	IP address is not set or ethernet function is not available.	HOSTADDR	An IP address has not been assigned to the GM. Check the IP address settings.
652	SMTP server is not found.	HOSTNAME	The SMTP server host name is invalid. Check the DNS address setting on the GM. Also, check the SMTP server address setting.
653	Cannot initiate E-mail transmission.	HELO	Failed to log in to the SMTP server. Check the user authentication settings of the SMTP server.
654	Sender's address rejected by the server.	MAILFROM	
655	Some recipients' addresses are invalid.	RCPTTO	The recipient address was rejected the SMTP server. Check the recipient address settings.
656	SMTP protocol error.	DATA	The mail body was rejected by the SMTP server. Check whether the SMTP server is operating properly.
		TCPIP	Internal processing error. Contact your nearest YOKOGAWA dealer.
657	Ethernet cable is not connected.	LINK	The Ethernet cable is not connected. Check the Ethernet cable connection.
658	Could not connect to SMTP server.	UNREACH	Failed to connect to the SMTP server. Check the Ethernet cable connection. Also, check the SMTP server address setting.
660	E-mail transfer error.	TIMEOUT	The response from the SMTP server timed out. Check that the Ethernet cable is connected correctly. Also, check whether the SMTP server is operating properly.
671	Could not connect to POP3 server.	POP3UNREACH	Failed to connect to the POP3 server. Check the POP3 server address setting.
		POP3HOSTNAME	The POP3 server host name is invalid. Check the DNS address setting on the GM. Also, check the POP3 server address setting.
672	Not able to login to the POP3 server.	POP3TIMEOUT	The response from the POP3 server timed out. Check that the Ethernet cable is connected correctly. Also, check whether the SMTP server is operating properly.
		POP3AUTH	User authentication on the POP3 server failed. Check whether the user name and password for POP3 authentication are correct.
673	SMTP authentication failed.	SMTPAUTH	Check whether the user name and password for authentication are permitted on the server.
674	The server requested an unsupported authentication method.	ANOTSUPPORT	Use the appropriate authentication method, or change the server configuration.

- **Errors Related to FTP Client**

Detail codes are not displayed for error messages on the screen. You can view them on the GM FTP log screen or through an FTP log output via communication.

Further details are provided by the character string (detail code) that appears after code.

Code	Message	Character String	Description, Corrective Action, Ref. Section
657	Ethernet cable is not connected.	LINK	The Ethernet cable is not connected. Check the Ethernet cable connection.
691	IP address is not set or FTP function is not available.	HOSTADDR	An IP address has not been assigned to the GM. Check the IP address settings.
692	FTP control connection error.	UNREACH	Failed to connect to the FTP server. Check whether the GM IP address and the connection destination FTP server are set correctly.
		REPLY	An error response was received from the FTP server. Check whether you have privileges to write files to the destination FTP server.
		SERVER	An unknown response was received from the FTP server. Check whether you are using the correct FTP server.
		HOSTNAME	The specified FTP server host name is invalid. Check the DNS and host name settings.
693	FTP command was not accepted.	COMSEND	Failed to send a command to the FTP server. Check whether the Ethernet cable is connected and whether the FTP server is down.
		COMRECV	Failed to receive a response from the FTP server. Check whether the Ethernet cable is connected and whether the FTP server is down.
		USER	The specified user name is not registered on the destination FTP server. Check whether the user name is set correctly.
		PASS	Password authentication failed at the destination FTP server. Check whether the password is set correctly.
695	FTP data connection error.	CONNECT	Failed to establish a data transfer connection with the FTP server. PASV mode may be necessary depending on the network environment. Check the PASV mode settings.
		RECV	Failed to receive data over the data transfer connection with the FTP server. Check whether the Ethernet cable is connected and whether the FTP server is down.
		SEND	Failed to send data over the data transfer connection with the FTP server. Check whether the Ethernet cable is connected and whether the FTP server is down.
696	FTP file transfer error.	FILE	File operation failed during file transfer. Check whether the external storage medium is inserted.
698	Connection time-out occurred for FTP.	TIMEOUT	Connection with the FTP server timed out. Check whether the Ethernet cable is connected and whether the FTP server is down.
699	An error occurred for FTP	TCPIP	An internal processing error occurred. Contact your nearest YOKOGAWA dealer.
		NOFD	
		NOID	
		PARAM	

Note

- The FTP client function on the GM has a timer function that drops the connection if there is no data transfer for two minutes. If the server does not respond within this time period, the transfer fails.
- The FTP client function on the GM overwrites files without a warning if files with the same name exist at the transfer destination unless the server returns a negative response.

- **SNTP Errors**

Code	Message	Character String	Description, Corrective Action, Ref. Section
711	SNTP access failure.	ESEND	Failed to transmit data to the SNTP server. Check the GM Ethernet cable connection and IP address setting.
		ERECV	Failed to receive data from the SNTP server. Check the GM Ethernet cable connection and IP address setting.
		EDORMANT ETCPIP	An internal processing error occurred. Contact your nearest YOKOGAWA dealer.
712	NTP server does not respond.	ETIMEDOUT	The response from the SNTP server timed out. Check the GM Ethernet cable connection.
713	Incorrect SNTP server setting.	EHOSTNAME	The SNTP server host name is invalid. Check the GM Ethernet cable connection, IP address setting, and SNTP server address setting.
714	Invalid SNTP server reply.	EBROKEN	The SNTP server returned an invalid response. The SNTP server may be in a condition that cannot deliver time information. Check the SNTP server status.
715	No time correction because excess time deviation with SNTP server.	EOVER	The time difference between the GM and SNTP server has exceeded the limit for correcting the time. Check whether the SNTP server is running properly and the limit for correcting the time.

• **DHCP Errors**

Code	Message	Character String	Description, Corrective Action, Ref. Section
721	IP address was released because DHCP setting is invalid.	REJECTING	The IP address obtained from the DHCP server was rejected. Check whether the DHCP server is operating properly. If the GM cannot accept the IP address obtained from the DHCP server, the GM rejects the address and immediately returns a response to the DHCP server.
722	DHCP access failure.	ESEND	DHCP message transmission failed. Check the Ethernet cable connection.
		ESERVER	DHCP server search failed. Check whether the DHCP server is available.
		ESERVFAIL	The response from the DHCP server timed out. Check the Ethernet cable connection. Check whether the DHCP server is operating properly.
		ERENEWED	IP address renewal failed. Check the Ethernet cable connection. Check whether the DHCP server is operating properly.
		EEXTENDED	IP address extension application failed. Check the Ethernet cable connection. Check whether the DHCP server is operating properly.
		EEXPIRED	IP address lease period expired. IP address was reset to 0.0.0.0. Check the Ethernet cable connection. Check whether the DHCP server is operating properly.
723	Registration of the hostname to the DNS server failed.	EFORMERR	DNS message syntax error was found. Check whether the DNS server is operating properly.
724	Deletion of the hostname to the DNS server failed.	ESERVFAIL	An internal processing error occurred in the DNS server. Check whether the DNS server is operating properly.
		ENXDOMAIN	Query to the DNS server wave rejected.
		EREFUSED	Check whether the GM domain name setting is correct.
		EINTERNAL	
		ENONAME	
		EYXDOMAIN	The GM does not support DNS servers that require host name registration authentication.
		EYXRESET	
		ENXRESET	Check whether the DNS server supports host name registration without authentication.
ENOTAUTH			
		ENOTZONE	

- **Other Communication Errors**

Code	Message	Character String	Description, Corrective Action, Ref. Section
731	Connection has been lost.	—	<p>If the GM receives data of improper protocol using general purpose communication (Ethernet or serial communication), the GM generates error 731 and disconnects the connection.</p> <p>(1) For an Ethernet connection, check the GM Ethernet cable connection.</p> <p>(2) For a serial connection, check the cable connection and the serial communication settings (baudrate, etc.).</p>
732	The number of simultaneous connections has been exceeded.	—	<p>This message is output when an attempt is made to establish five or more connections to the GM using general purpose communication (Ethernet).</p> <p>(1) Reduce the number of simultaneous connections.</p> <p>(2) Check whether there is a connection from another PC.</p> <p>(3) Turn on the timeout function in server settings.</p>
733	Communication has timed-out.	—	<p>This message is output when communication times out on general purpose communication.</p> <p>(1) Check the timeout value in server settings.</p> <p>(2) Reconnect to the GM.</p>
781	Failed to establish encrypted communication.	—	<p>Check the key, certificate, communication settings, and host device.</p>
782	Communication failed due to certificate.	—	<p>Failed to verify the certificate received from the server.</p> <p>Select the unverified certificate, and check the details.</p>
783	Wrong validity certificate.	—	<p>There is an error in the validity of the certificate received from the server or a trusted certificate in the device.</p>

- **Errors for When the Advanced Security Function (/AS option) Is in Use**

For information about the GM advanced security function (/AS option), see the Data Acquisition System GM Advanced Security Function User's Manual, IM04L55B01-05EN.

Communication Errors

For information about the GM communication functions, see the Communication Command User's Manual, IM04L51B01-17EN.

• Execution Errors

Code	Message	Description, Corrective Action, Ref. Section
351	Command is too long.	Check the communication command specifications.
352	Unknown command.	
353	This command is not permitted in this user.	Log in using a user account that has permission to use the operation.
354	This command is not permitted in this mode.	
355	The option is not installed.	Check the communication command specifications.
356	This command is not permitted in this setting.	Log in using a user account that has permission to use the operation.
357	Wrong command arguments number.	Check the communication command specifications.
358	This command does not support a query.	
361	Wrong error number.	This is an unregistered error number. Please check the error number.
401	A user name and password is required.	Log in.
411	Exceeded number of selection.	In manual select saving, set the number of specified data files to 50 or less.
412	No data exists.	Check that the file specified by memory summary and the like exists.

Status Messages

Code	Message
801	Execution completed.
802	Please wait a moment...
803	Saving data to media.
804	Loading file from media.
805	Memory save to media stopped.
806	Data save completed.
809	Post process in progress.
811	No unsaved data.
812	Media mounted.
815	Failed to mount the media.
819	Wrong format media.
820	Loading on hold while predictive detection is in progress.
821	Ethernet cable connected.
822	Ethernet cable disconnected.
823	Connecting to the line...
824	Sending data file.
825	Executing FTP test.
826	Executing e-mail test.
827	Now connecting to SNTP server...
828	Querying to DHCP.
830	Received response from DHCP.
831	IP address set.
832	No hostname registration to DNS server in current settings.
833	Registered hostname to DNS server.
834	Deleted hostname in DNS server.
836	KDC test connection succeeded.
837	Login may be impossible in incorrect KDC client settings.
841	Now adjusting the time.
850	Saving Settings.
851	Attached a module.
852	Updating I/O module firmware.
853	System reconstruction in progress.
854	Executing A/D calibration.
855	Initialization in progress.
856	Writing the A/D calibration value.
857	Resetting the A/D calibration value.
858	Detected new modules. Required System Reconfiguration.
860	Please set as recording channel.
861	Noise may influence measurement in fast mode.
862	Please acknowledge all active alarms before stopping this record.
863	Changed the recording interval.
864	Setting changes exceeded 50. Not possible to save beyond 100. Please save now.
865	"Relay Action on ACK" setting of all DO channel will change to "reset".
866	Not available for electric signature. Please set the certificate.
867	Not available for encrypted comm. Please set the certificate.
868	Chattering filter may not function. Please update module to R1.04.01 or later.
869	Before saving these settings, register users in the User settings menu under Security settings.
877	Time event setting has changed.
878	Input time event time less than segment time.
880	Reconfigure pattern data related to control loops (Starting target setpoint, wait settings, and segment settings)
881	Initialized measured data and settings.
882	Initialized measured data.
886	The selected channel is not enabled. Please check the channel settings.
891	Changed the language. Please reboot the system.
892	Please reboot the system.

Note

If E819 occurs, take the following corrective action.

- SD memory card
Format the SD memory card using the SD memory card formatter distributed by the SD Association.

System Errors

Servicing is required when a system error occurs. Contact your nearest YOKOGAWA dealer for repairs.

Code	Message	Description, Corrective Action, Ref. Section
901	ROM failure.	Servicing is required. Contact your nearest YOKOGAWA dealer for repairs.
902	RAM failure.	Servicing is required. Contact your nearest YOKOGAWA dealer for repairs.
911	A/D calibration value error.	
912	A/D calibration error.	Check that the reference value is correct. Check that the wiring is correct. If the same message continues to appear even after you perform the procedure above, servicing is required. Contact your nearest YOKOGAWA dealer for repairs.
913	Incorrect number for the A/D calibration.	Select a number of a module that has been detected.
914	Failed to write A/D calibration value.	Failed to write A/D calibration values to the module. Check that the module is installed correctly. Do not remove the module during calibration. If the same message continues to appear even after you perform the procedure above, servicing is required. Contact your nearest YOKOGAWA dealer for repairs.
915	Failed to receive A/D calibration value.	Failed to receive A/D calibration values from the module. Check that the module is installed correctly. Do not remove the module during calibration. If the same message continues to appear even after you perform the procedure above, servicing is required. Contact your nearest YOKOGAWA dealer for repairs.
916	Incorrect A/D calibration procedure.	Calibrate correctly.
921	Memory acquisition failure.	Perform the following tasks. 1. Stop recording. 2. Save the measured data that is stored in internal memory to an external storage medium. 3. Initialize the internal memory data. If the same message continues to appear even after you perform the procedure above, servicing is required. Contact your nearest YOKOGAWA dealer for repairs.
922	The ethernet module is down.	Servicing is required. Contact your nearest YOKOGAWA dealer for repairs.
923	A hardware test failed.	Servicing is required. Contact your nearest YOKOGAWA dealer for repairs.
924	The backup battery is low.	
951	Data are not written at the flash memory area for production.	Servicing is required. Contact your nearest YOKOGAWA dealer for repairs.
952	A SUM value of the flash memory area for production is incorrect.	
953	The reading of the flash memory area for production failed.	
954	The writing of the flash memory area for production failed.	Servicing is required. Contact your nearest YOKOGAWA dealer for repairs.
999	System error.	

Expansion Module Error Codes

Error	Error Name	Error Description	Corrective Action
F1	Secondary boot read error	Failed to read the secondary boot program of the expansion module. There may be a problem reading the flash RAM.	Contact your nearest YOKOGAWA dealer.
F2	Firmware download error	Failed to read the flash memory of the expansion module.	
F3	DRAM read error	There is an error in the DRAM of the expansion module.	
F4	System data error	There is an error in the system data (MAC address, product serial number) of the expansion module.	
F5	Ethernet error	There is an error in the EXBus controller of the expansion module.	
E1	Unit number error	The unit number setting is incorrect.	Set the unit number in the range of 0 to 6.
E2	Multiple expansion module connection	There are multiple expansion modules connected to the GM or a sub unit.	Install a single expansion module in the correct slot.
E3	Slot error	An expansion module was installed to an in appropriate slot position when the module is operating in slave mode.	Install the expansion module in the correct position.
E4	Duplicate unit numbers	There are duplicate expansion module unit numbers.	Turn off the main unit and all sub units and expandable I/O units that are connected. Then, reassign the unit numbers so that they do not overlap.
E5	Download error	Failed to update the expansion module.	Update the expansion module again.
E6	Extended unit master mode error	The master I/O expansion or slave I/O expansion operation setting of the expansion module is incorrect.	Set dipswitch 8 of the expansion module correctly.
E7	EXBus connection error	A device other than an expansion module is connected to EXBus.	Disconnect devices other than the expansion module from EXBus.
E8	Module connection error	A module is installed in slot 6 or later.	Install it between slots 0 and 5.
Px (x: 0 to 5)	Module insertion and removal	Appears when a module is inserted or removed. x indicates the slot number.	—

Messages That the Web Application Generates

• Error Messages

Code	Title Message	Description and Corrective Action
E8001	Communication error A communication error has occurred.	This message appears when processing cannot be completed because Ethernet communication with the GM is not possible. Example: The communication is disconnected during login authentication. Check the communication environment. Check example: If the target GM can be found with IP Address Configurator, the target GM is in the same network as the PC. Check the IP address settings.
E8002	Authentication error Login failure; the page will be reloaded.	Due to a change in the user registration settings on the GM, an authentication procedure has occurred while the Web application was running and has failed. Click OK in the dialog box to reload the page.
E8003	Configuration loading error Failed to load hardware configuration. Auxiliary Message 1 There is a communication error or the hardware is busy. 2 The configuration you are loading is not fully compatible with the existing configuration of hardware.	This message appears when the Web application fails to load settings from the GM. The system configuration or settings on the GM have been changed, and a conflict has occurred with the settings displayed by the Web application. Check the system configuration and settings on the GM. Also, check the communication condition.
E8004	Configuration updating error Failed to update hardware configuration. Auxiliary Message 1 There is a communication error or the hardware is busy. 2 The configuration you are updating is not fully compatible with the existing configuration of hardware. 3 There are invalid MATH expressions. 4 This username is already registered.	This message appears when the Web application fails to change the GM settings. There is a conflict in the system configuration or settings between the GM and the Web application. Reload the settings to align the Web application settings to the GM settings (settings that have been edited will be discarded). Error in expression. A user with the same user name is already registered.
E8005	File The file name is invalid. Auxiliary Message 1 A file name can not contain any of the following characters. \"/<?> '; 2 The length of file name is up to 32 characters.	Set the file name using up to 32 alphanumeric characters.
E8006	Configuration error Failed to operate due to communication error. Auxiliary Message 1 The configuration is not fully compatible with the existing configuration of hardware.	When AI channels are being configured, the available alarm range of channels that are set to Log scale are retrieved from the GM via communication. If a communication error occurs during this process, the available range cannot be retrieved, and this message is displayed. When this message appears, we recommend that, after communication is restored, you reload the settings.
E8007	Certificate Creation Error Failed to create certificate. Check the following. Auxiliary Message 1 Cannot use ! " # \$ % & ' ^ ; ? 2 The country name must be in alphabet a-z, A-Z.	Failed to create a certificate.
E8008	Authentication error Password entered is incorrect.	The passwords entered for the new password and confirmation do not match when changing the password at login (when the password is initialized or when the password is expired). Enter the same character string for both.

Continued on next page

5.2 Troubleshooting

Code	Title Message	Description and Corrective Action
E8009	Authentication error This function is not possible now.	This message appears in the following cases. 1. If the GM login settings (User ID On/Off and the like) has been changed from somewhere else (when the login dialog box is displayed and when the Login button in the login dialog box is pressed). Log in again. 2. If a portion of communication errors (when communication is disconnected) occurs (when the standby display persists after the OK button is pressed) Take the same corrective action as 8001.
E8010	Program operation Program operation not started.	This message appears when you press RUN PANEL on the program selection screen when a program is not running. The screen does not switch to the program operation screen.
E8011	Configuration error The input numerical value exceeds the set range.	This message appears when setting entry fails on the following setting screen. • Report channel setting (in Dual interval mode) When the scan interval of measurement group 1 is 50 ms or less, there is a high limit to the number of channels that can be assigned to report channels that can be set from measurement group 1. This message appears when you try to enter more than this high limit.
E8601	Registration error The monitor name must be 1-16 characters in length.	Use 1 to 16 characters to set the favorite monitor name.
E8602	Registration error Failed to add a monitor because the maximum number of allowed monitors has been reached.	Delete at least one favorite monitor and start over, or overwrite an existing favorite monitor.
E8603	Registration error Failed to update favorite monitor information; this action has already been performed. Please reload the page.	Because the favorite monitor information that the browser has detected is different from what is stored in the GM, registering, overwriting, or deleting of the favorite monitor failed. Reload the page.
E8604	Communication error Failed to operate due to communication error.	Operation failed due to a communication error. Check the communication conditions.
E8605	Communication error Communication error occurred. Please restart the web browser.	Follow the instruction below to restart the browser. 1 Close the browser. 2 Check the communication conditions. 3 Start the browser, and connect to the Web application.

• Warning Messages

Code	Title Message	Description and Corrective Action
W8101	Clear the editing Are you sure you want to clear the edited content?	This confirmation message appears when you edit settings and try to move to a different setting screen without clicking Update Config .
W8102	Reload configuration If the display language is changed, the page will be reloaded.	This confirmation message appears when you try to change the language setting.

Continued on next page

Code	Title Message	Description and Corrective Action
W8103	Update configuration Are you sure you want to update the hardware configuration? Auxiliary Message	This confirmation message appears when you click Update Config. in a setting screen.
	1 Communication will be disconnected when you change Ethernet basic settings. If it be disconnected, please reconnect with new settings.	
	2 Communication will be disconnected when you change to HTTP Off. You cannot change HTTP On from the web application.	
	3 Communication will be disconnected when you change the port number for HTTP. After the configuration is completed, please reconnect with the new port number.	
	4 Change the communication security. After the configuration is completed, the page reload or user authentication are required.	
	5 Change user settings, including current log in. After the configuration is completed, the page reload or user authentication are required.	
	6 Not available for electric signature. Please set the certificate.	
	7 Not available for encrypted comm. Please set the certificate.	
	8 Bluetooth connection list will be cleared.	
	9 Before save this configuration, do the user registration from security settings - User settings menu	
W8104	Update configuration Restart is required to reflect this changes. Continue?	This confirmation message appears after you change the settings when the GM needs to restart.
W8105	Reload configuration Are you sure you want to clear the edited contents by reloading the configuration?	This confirmation message appears when you click Reload in a setting screen.
W8106	Destruction of editing Are you sure you want to clear the edited monitor?	This message appears for you to confirm whether to discard the current monitor and move to different content. If you want to save the monitor configuration, register the monitor as a favorite monitor, and then move to different content.
W8107	Login user changed Login user has changed. The page will be reloaded.	Due to a change in the user registration settings on the GM, an authentication procedure has occurred while the Web application was running, and as a result, the login user has changed. Click OK to reload the page.
W8108	Hardware configuration Hardware system configuration has changed. The information will be updated.	This message appears on the system information screen or network information screen when the system configuration changes on the GM. Click OK to update the information.
W8109	Limit of configuration editing This configuration includes contents that could not be changed. Auxiliary Message	This message appears when setting parameters are loaded. It indicates that restrictions will be placed on the configuration capabilities due to the GM condition or design limitations of the Web application.
	1 The hardware is recording data or executing math, so the configuration cannot upload.	
	2 The configuration you are loading includes the contents that cannot be changed from the web application.	

Continued on next page

5.2 Troubleshooting

Code	Title Message	Description and Corrective Action
W8110	Limit of configuration editing The hardware was operated, so this operation will affect the configuration. Auxiliary Message 1 The hardware is recording data or executing math, so the configuration cannot upload. 2 The hardware was operated. The configuration is not fully compatible with the existing configuration of hardware. 3 The hardware is currently running control, therefore, the configuration cannot be loaded.	This message appears when settings are being displayed. It indicates that restrictions will be placed on the configuration capabilities due to changes in the GM condition.
W8111	Save all Save files to the current folder? Auxiliary Message • Setting parameters, Report template (/MT), Trusted Certificate, Certificate, Profile trend (/MC), Predictive detection model • Program pattern	This message appears during all settings save.
W8112	Load all Load files from the current folder? Auxiliary Message • Setting parameters, Report template (/MT), Trusted Certificate, Profile trend (/MC), Predictive detection model • Program pattern	This message appears during all settings load.
W8113	File Delete the file?	This message appears when files are deleted from the saved/loaded contents.
W8114	Reconfiguration • Reconfigure modules? • (Caution) If the PID control module has been detached, relevant program pattern settings will be cleared.	This message appears when performing reconfiguration.
W8115	Mode Switching Exit current mode? Auxiliary Message 1 This requires reboot the hardware. 2 Current execution process will be canceled. 3 Confirm that hardware is not executing calibration.	This message appears when you • click the button that returns to normal mode in the information message 8203, 8204, or 8205 dialog box or • click the End button for the update content.
W8116	Mode Switching Switch to A/D calibration mode? Auxiliary Message 1 This requires reboot the hardware.	This message appears when you click the A/D calibration mode button for the A/D calibration content.
W8117	Mode Switching Exit A/D calibration mode? Auxiliary Message 1 This requires reboot the hardware. 2 Calibration values that being edited is discarded when their values which is not written in exists.	This message appears when switching from A/D calibration mode to normal mode.
W8118	A/D calibration Calibration values that being edited is discarded when their values which is not written in exists.	This message appears on the A/D calibration mode screen when you try to select another module when there are ranges for which the calibration execution results have not been written.
W8119	Encryption function On/Off Are you sure you want to update the hardware configuration? Auxiliary Message 1 This requires reboot the hardware.	This message appears when the encryption function on/off state is changed.

Continued on next page

Code	Title Message	Description and Corrective Action
W8120	Create a key Create the key. Switch to the key creation mode? Auxiliary Message 1 This requires reboot the hardware. 2 Creating key may take a while. 3 Delete the installed server certificate.	This message appears when you try to create a key.
W8121	Create a key Cancel to create the key ? This requires reboot the system. Auxiliary Message 1 This requires reboot the hardware.	This message appears when you try to cancel while creating a key.
W8122	Unverified certificate Communication failed due to certificate. Auxiliary Message 1 Operation: Unverified certificate	Check the certificate. You can display the details of a problematic certificate and execute authentication (or load) by using Unverified certificate from the menu.
W8123	Certificate Installed certificate exists. Overwrite the certificate?	This message appears during certificate installation when a certificate is already installed when you are creating a self-signed certificate.
W8124	Limitation of Function Cannot use this function currently. Auxiliary Message 1 This operation is not permitted in this mode. 2 Cannot use this function when connected by HTTPS.	This message appears when you try to select a function that cannot be used currently.
W8125	Communication Communication disconnected. Please reload later.	This message appears while waiting for the results of processing when some time elapses after communication is disconnected.
W8127	Mode Switching Switch to update mode? Auxiliary Message 1 This requires reboot the hardware.	This message appears when you click the Update button for the A/D calibration content.
W8126	Mode Switching Changed hardware mode, reloading the page.	This message appears when the main unit mode is changed.
W8129	Display Settings Layout may be displayed incorrectly in case of zoom is not 100%.	This message appears when the Web browser zoom may not be set to 100%. It appears once when you start the Web application.
W8130	A/D calibration Save calibration value?	This message appears on the A/D calibration mode screen when the calibration execution results are about to be written.
W8131	A/D calibration The calibration value is reset to the factory default value. Abort calibration without saving?	This message appears on the A/D calibration mode screen when you are resetting calibration.
W8132	Advanced security settings Are you sure you want to update the hardware configuration? Auxiliary Message 1 Data is initialized. Reboot the system ?	This message appears when the advanced security setting is switched.
W8133	Logout Are you sure you want to logout?	This message appears when the logout button is pressed.
W8134	Save all SETTINGS Same folder name exists, overwrite?	This confirmation message appears when the folder name specified for all settings save already exists.
W8136	Update configuration Multi batch settings have been changed. Auxiliary Message 1 Please reload after restart of the hardware.	This message appears when the Web application detects a change in the multi batch settings. Reload the settings to avoid conflict between the GM and Web application.

Continued on next page

5.2 Troubleshooting

Code	Title Message	Description and Corrective Action
W8137	Multi batch settings 1 Are you sure you want to update the hardware configuration? Auxiliary Message System is rebooted. All initialization is done except log, communication basic settings, and Communication server settings. Is it OK?	This confirmation message appears when you click Update Config. in the multi batch setting screen.
W8138	Auto-tuning CAUTION: Do not perform auto-tuning for the following processes. Tune PID manually. Auxiliary Message <ul style="list-style-type: none"> Processes with fast response such as flow rate control and pressure control. Processes which do not allow the output to be turned on and off even temporarily. Processes which prohibit output changes at control valves (or other actuators). Processes in which product quality can be adversely affected if PV values fluctuate beyond their allowable ranges. 	This message appears when you click Auto-tuning (AT: OFF) on the tuning screen.
W8139	Abort auto-tuning Abort auto-tuning?	This message appears when you try to stop auto-tuning while auto-tuning is in progress.
W8140	Measurement mode Are you sure you want to update the hardware configuration? Auxiliary Message Data is initialized. Reboot the system?	This message appears when you click Update Config. in the measurement mode setting screen.
W8141	Program operation (PROGRAM RUN/RST) Execute program control RUN/RESET.	This message appears when you click PROGRAM RUN/RESET on the program operation screen.
W8142	Program operation (PROGRAM RUN) Start program control?	This message appears when you click PROGRAM RUN on the program operation screen.
W8143	Advance of segment (ADVANCE) Advance program to the next segment?	This message appears when you click ADVANCE on the program operation screen.
W8144	Hold Hold program operation?	This message appears when you click HOLD on the program operation screen.
W8145	Hold Release hold operation?	This message appears when you click HOLD on the program operation screen in hold mode.
W8146	Pattern number (SET PT NO.) Change action pattern number into displayed pattern number?	This message appears when you click SET PT NO on the program selection screen.
W8147	Update configuration Measurement mode have been changed. Auxiliary Message Please reload after restart of the hardware.	This message appears when the measurement mode is changed.
W8148	Update configuration If this web option is changed, the page will be reloaded.	This message appears when you change the following items from the Web option dialog box. <ul style="list-style-type: none"> Language Control screen background
W8156	Web application Layout may be displayed incorrectly in case of display zoom or browser zoom is not 100%. It may be fixed by changing browser zoom.	If using Chrome, this message is displayed if the zoom factor in the Windows display settings or the browser is not 100%. The layout of the table header on the settings page can become disrupted. Changing the browser's zoom factor may alleviate the problem.
W8158	Configuration The selected channel is not enabled. Please check the channel settings.	Check whether any of the following conditions apply for the selected channel: <ul style="list-style-type: none"> The range type specifies a Skip channel A channel that is not in use (On/Off is Off) is specified The AI channel specifies a channel for LOG computation

Continued on next page

Code	Title Message	Description and Corrective Action
W8701	Favorite monitor The monitor with the same name already exists. Do you want to overwrite it?	This message confirms whether it is okay to overwrite an existing favorite monitor. If you do not want to overwrite, click Cancel , and then register with a different name.
W8702	Favorite monitor Are you sure you want to delete \"%s\"?"	This message confirms whether it is okay to delete a favorite monitor. The "%s" section will contain the favorite monitor name.

• Information Messages

Code	Title Message	Description and Corrective Action
M8201	Hardware configuration Hardware system configuration has changed.	This message appears when the system configuration changes on the GM.
M8202	Update configuration Configurations were updated successfully.	The GM settings have been successfully changed.
M8203	Update Mode Hardware is in Update mode. Please wait. Auxiliary Message 1 Module updating... (xxx%) 2 Modules not updated. 3 Web application updating... (xxx%) 4 Web application not updated.	<p>This message appears in the following cases.</p> <ul style="list-style-type: none"> • When a connection is made with the GM in update mode • While connected to the GM in normal mode, another Web browser changes the GM to update mode <p>This auxiliary message appears in the following cases.</p> <ol style="list-style-type: none"> 1 When module updating is in progress 2 When module updating is not in progress <ol style="list-style-type: none"> 3 When Web application updating is in progress 4 When Web application updating is in not progress <p>Clicking Exit current mode displays W8115 and returns the GM to normal mode.</p> <p>While updating is in progress, the Exit current mode button cannot be used.</p> <p>Mode cannot be switched with a User connection. The Exit current mode button will be hidden.</p>
M8204	A/D Calibration Mode Hardware is in A/D calibration mode. Please wait.	<p>This message appears in the following cases.</p> <ul style="list-style-type: none"> • When a connection is made to the GM in A/D calibration mode • While connected to the GM in normal mode, another Web browser changes the GM to A/D calibration mode. <p>Clicking Exit current mode displays W8115 and returns the GM to normal mode.</p> <p>When returning the GM10 to normal mode, confirm that the GM10 is not executing A/D calibration. You can confirm by looking at the GM10 LED.</p> <p>Mode cannot be switched with a User connection. The Exit current mode button will be hidden.</p>
M8205	Key Creation Mode Created key pairs. Please reboot the system. Auxiliary Message 1 Key not created. 2 Key creation in progress. (xxx%)	<p>This message appears in the following cases.</p> <ul style="list-style-type: none"> • When a connection is made to the GM in key creation mode • While connected to the GM in normal mode, another Web browser changes the GM to key creation mode <p>Clicking Exit current mode displays W8115, cancels key creation, and returns the GM to normal mode.</p> <p>Mode cannot be switched with a User connection. The Exit current mode button will be hidden.</p>
M8206	A/D calibration Executed successfully.	This message appears when calibration is executed successfully.
M8207	Create a key Created key pairs. Please reboot the system. Auxiliary Message 1 This requires reboot the hardware.	This message appears when a key is created successfully.
M8208	Update Update completed.	This message appears when updating is complete.

Continued on next page

5.2 Troubleshooting

Code	Title Message	Description and Corrective Action
M8209	Mode Switching Returned to normal operation display. Auxiliary Message 1 Key creation canceled.	This message appears in the following cases. <ul style="list-style-type: none"> • When the key that you are creating is complete, and the GM is returned to normal mode • When the key that you are creating is canceled • When the update mode screen that you opened is closed • When the A/D calibration mode screen that you opened is closed This auxiliary message appears in the following conditions. <ul style="list-style-type: none"> • When key creation canceled
M8210	— Media removed.	This message appears when the external storage medium is removed from the GM10.
M8211	Paste To paste, please press Ctrl + v or paste from the browser menu.	This message is displayed when you click the on-screen Paste button in Chrome.
M8801	Message The message was written successfully.	Message writing has been completed successfully.
M8802	Resumption of monitors Monitors resumed operation following setting changes.	The paused condition has been cleared due to a setting change in the GM that would cause the monitor to be initialized.

5.2.2 Troubleshooting

The GM does not work (nothing is displayed).

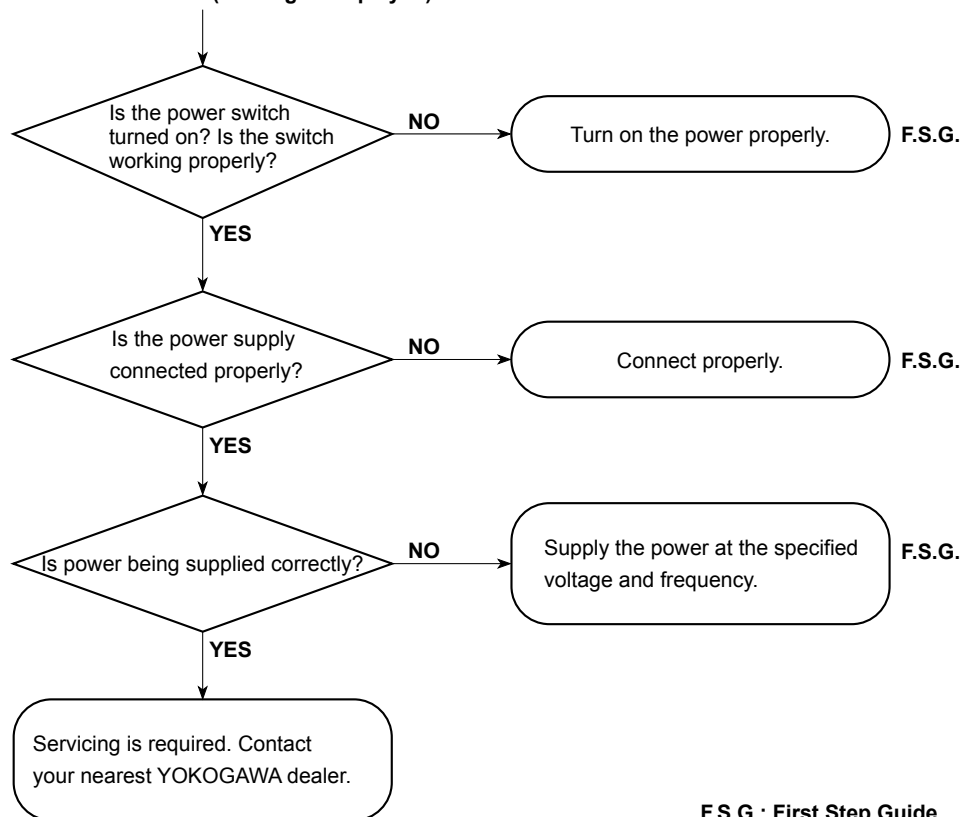

F.S.G.: First Step Guide

- The error is large.
- The trend or digital values fluctuate.
- The trend is off the scale on either the 0% or 100% side.

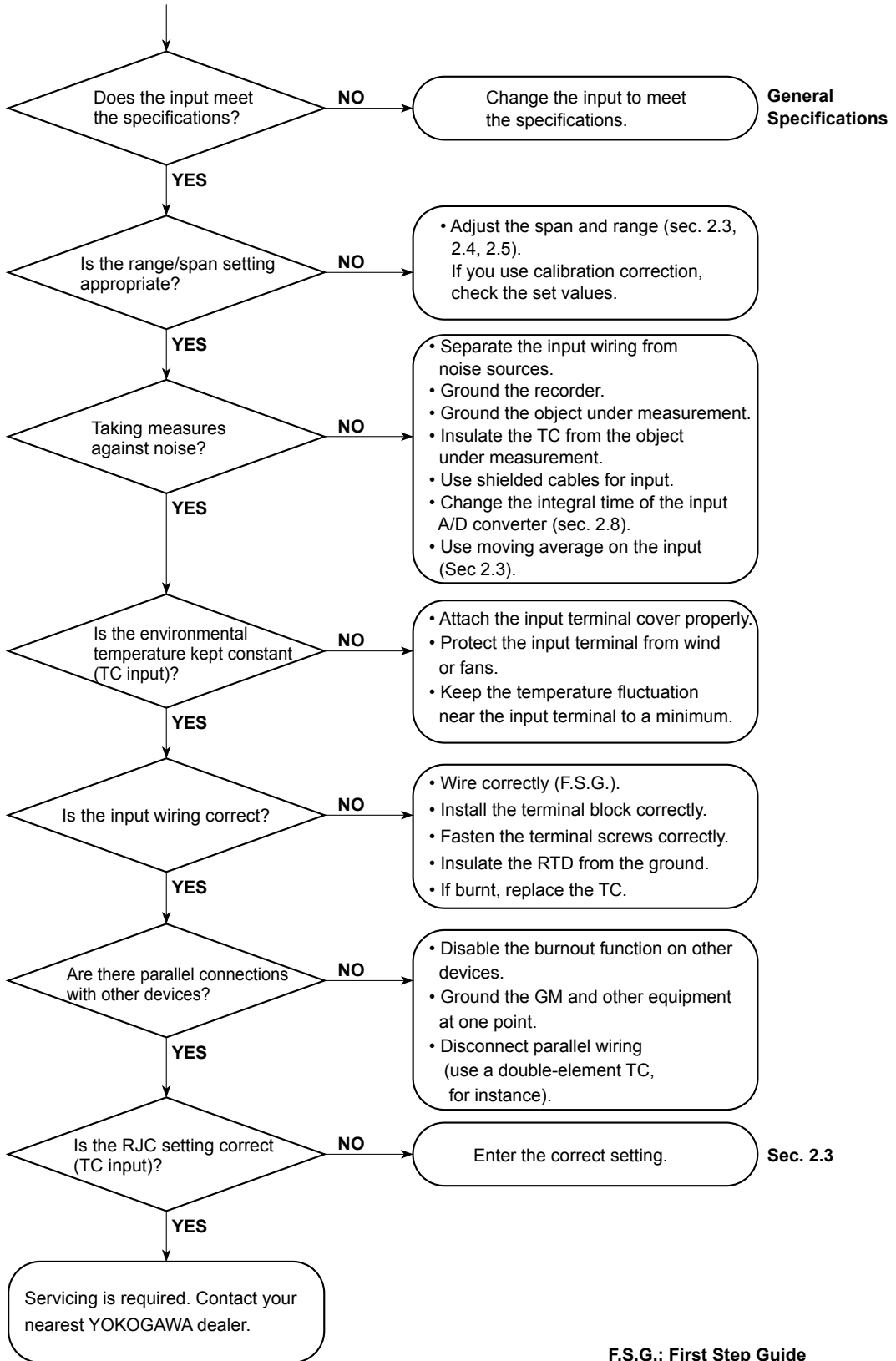

F.S.G.: First Step Guide

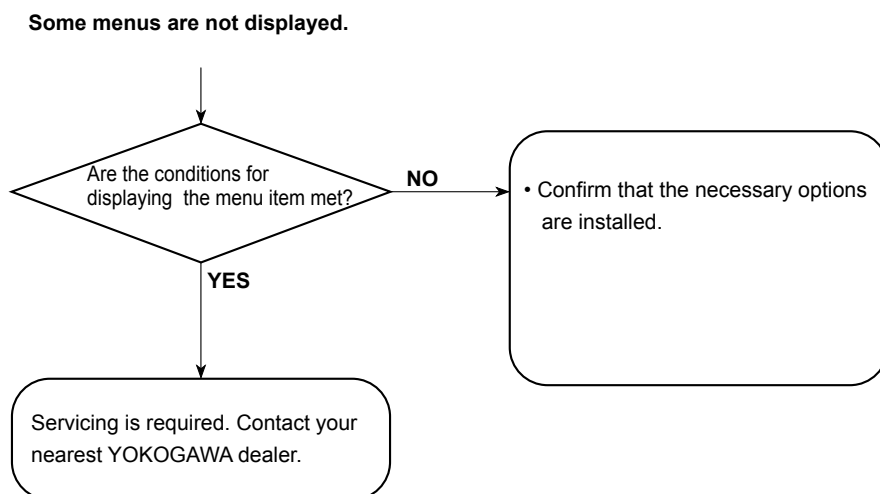
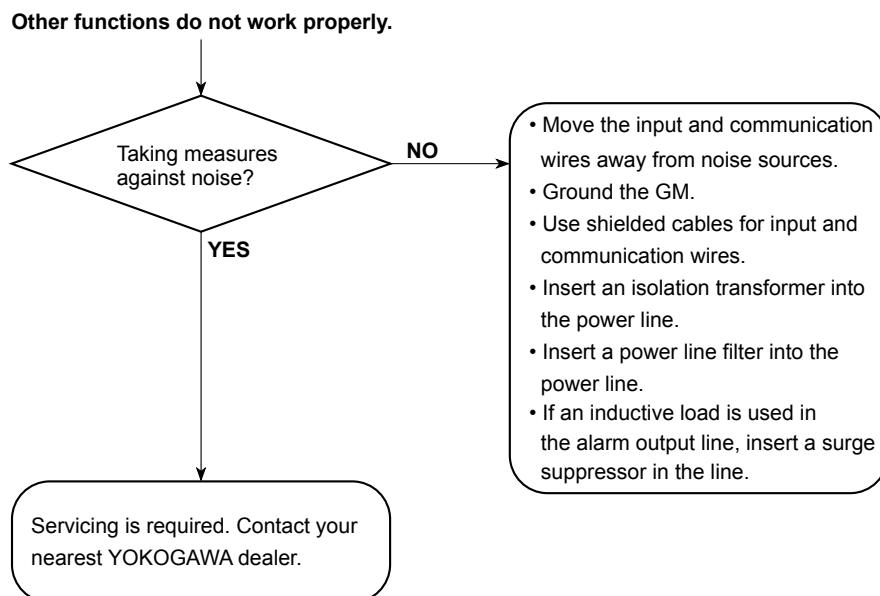

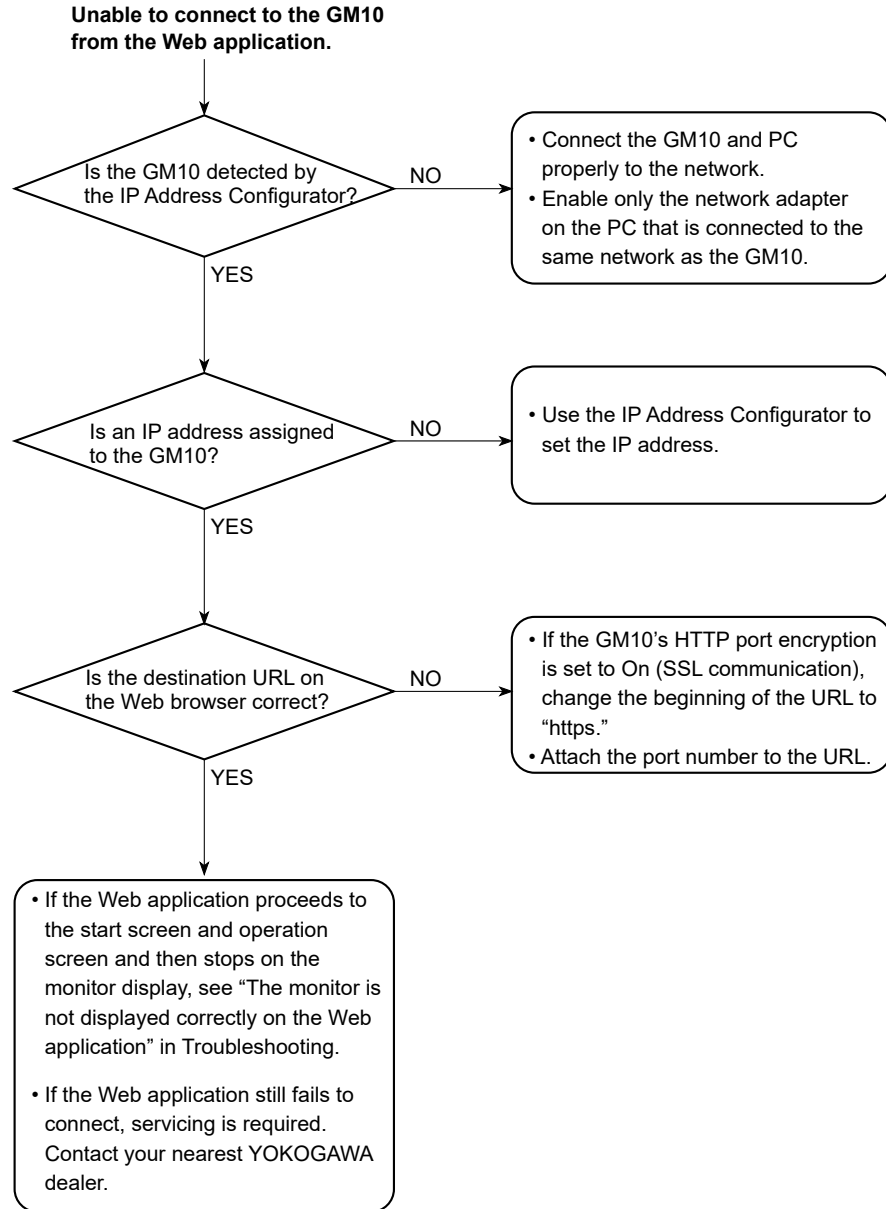

- After performing from the Web application an operation that causes the GM10 to restart (e.g., switching to A/D calibration mode, turning on or off the encryption function), the connection between the GM10 and Web application is disconnected.

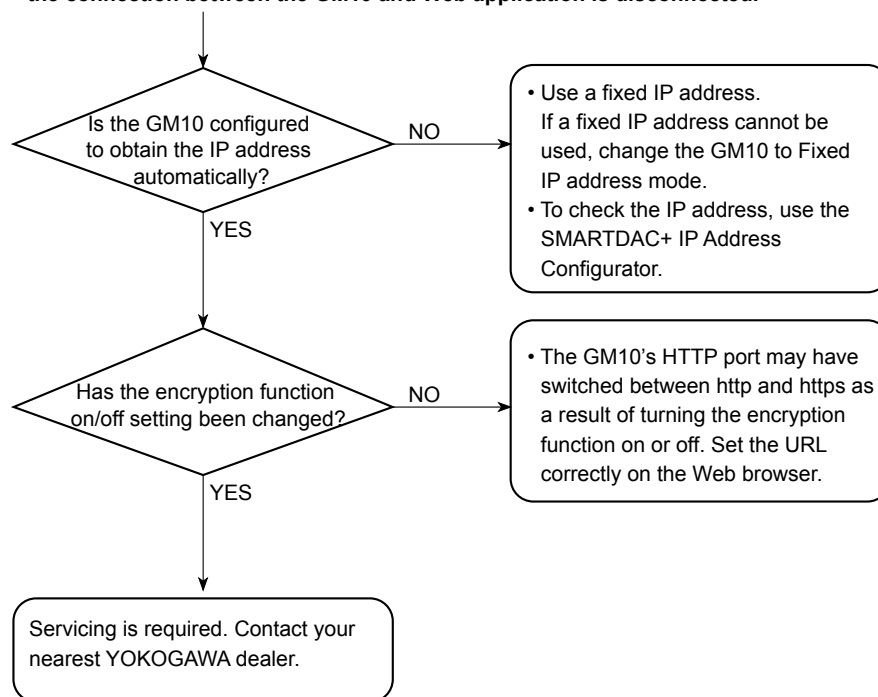

- Unable to update the Web application.
- Web application updating fails.

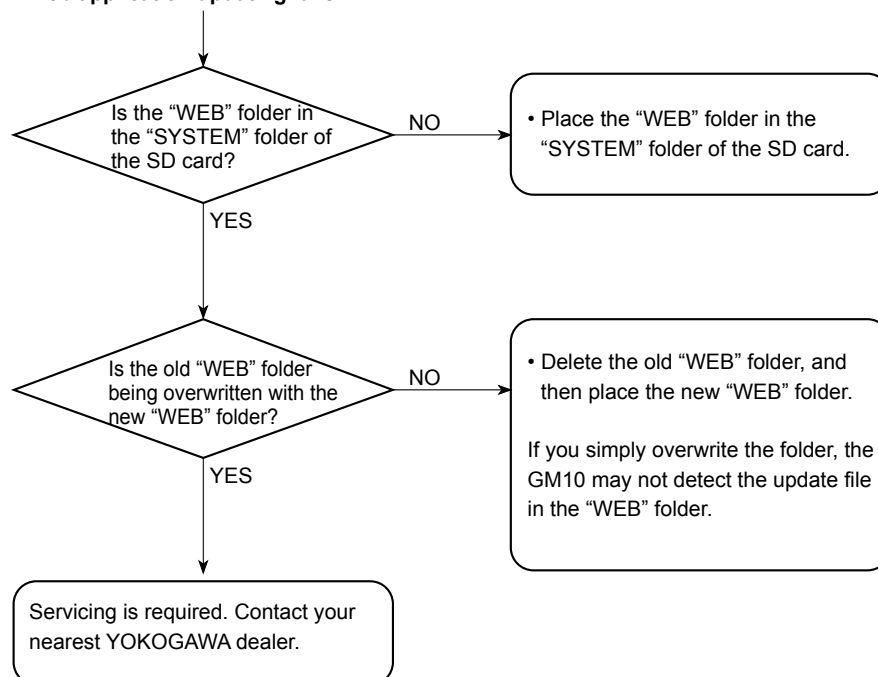

5.2.3 Auto Restart When a Device Error Occurs (Release number 4 (version 4.04) and later))

If an FPGA error or other device error occurs, the system is automatically restarted to prevent erroneous operation.

Data is not acquired during the auto restart procedure. In addition, an auto restart causes the measurement data file being recorded to be divided.

When an auto restart takes place, an error message is displayed or an auto message is written and an e-mail is sent depending on the settings.

- **Error message**

When an auto restart takes place, the following error message is displayed.

“E611 System rebooted due to FPGA software error.” or “E612 System rebooted due to CPU error.”¹

- **Auto message writing**

If recording is in progress, the following message is written automatically when an auto restart takes place.

“FPGA error Time of occurrence” or “CPU error Time of occurrence”¹

Example: FPGA error 2018/08/31 17:15:30

- **E-mail transmission**

If the system error notification is set to ON, an e-mail is sent when an auto restart takes place.

- **Measurement data file**

An auto restart causes the measurement data file being recorded to be divided. The Starting Cond. and Dividing Cond. for the division is indicated as “FPGA error or CPU error”¹.

¹ Release number 5 and later

Relay output and analog output caused by auto restart

- **Fail relay, output relay (DO of DO/DIO modules and PID modules)**

Relays are set to de-energized at auto restart. They return to their normal states when the auto restart is complete.

- **Analog output (AO modules)**

Preset action on error takes place during an auto restart. When the auto restart is complete, a power-on preset action takes place, and the output returns to its normal state.

- **Analog output (PID modules)**

Relays are set to 0 mA at auto restart. They return to their normal states when the auto restart is complete.

If the system does not recover with an auto restart or if an auto restart does not take place, contact your nearest YOKOGAWA dealer.

Appendix 1 File Size of Event Data and Display Data

This section explains how to calculate the file size of event data files and display data files. The calculation examples are given for the display data only and event data only cases. If you are recording both display and event data, calculate the data size of each and add them together. Use the calculated file size as a rough guide.

The calculations discussed here apply to a GM without the advanced security function (/AS option) or a GM whose advanced security function is disabled.

File Size

A file consists of the following data.

Information other than the sampled data + the sampled data + system information

The size of system information can range from 1 to 100 KB depending on how the system is configured and other conditions.

The maximum size of a single event data file or display data file is 18 MB.

Size of Information Other Than the Sampled Data

Item	Size (Bytes)
File format identification block	48
File information block	112
Event information block	304
Time zone information block	48
Alarm block	104 + 56 × the number of alarms (Up to 5000)
Message block	72 + 200 × the number of messages
Control information block	136 + 72 × number of loops + 40 × number of program patterns
Control summary block	104 + 64 × number of control summaries
Control alarm summary block	104 + 64 × number of control alarm summaries
Batch information block	2360
Display information block	224
Group information block	24 + 264 × the number of groups
Channel information block	24 + 328 × the number of recording channels
Calibration correction block	24 + (40 + 16 × number of correction points) × number of recording channels (excluding math channels)
Time change information block	280
Measurement data information block	96
Measurement data scan information block	40 + 16 × the number of recording channels

The number of recording channels is the total of all the channels that are recording. The number of correction points is set for each channel (when correction mode is off, the number of correction points is 0).

Example 1: When recording data for 30 I/O channels, 10 math channels, 50 communication channels, and 10 group channels. Here we assume that there are no messages, alarms, loops, program patterns, control summaries, or control alarms.

$$\begin{aligned}
 &48 + 112 + 304 + 48 + 104 + 72 + 136 + 104 + 104 + 2360 + 224 + (24 + 264 \times 10) \\
 &+ (24 + 328 \times 90) + (24 + 40 \times 80) + 280 + 96 + (40 + 16 \times 90) \\
 &= 40,904 \text{ bytes}
 \end{aligned}$$

Sampled Data Size

• Data Size of Event Data and Display Data

Channel	Display Data	Event Data
I/O channel	12 bytes/channel	6 bytes/channel
Math channel	12 bytes/channel	6 bytes/channel
Communication channel	12 bytes/channel	6 bytes/channel

Time data common to all channels is added for each sample.

Time data	16 bytes/sample
-----------	-----------------

- **Data Size per Sample**

Event Data

(Number of I/O channels × 6 bytes) + (number of math channels × 6 bytes) + (number of communication channels × 6 bytes) + 16 bytes (time data)

Display Data

(Number of I/O channels × 12 bytes) + (number of math channels × 12 bytes) + (number of communication channels × 12 bytes) + 16 bytes (time data)

- **Sampled Data Size per File**

Event Data

Data size per sample × data length / Recording interval

Example 2: When recording event data for 30 I/O channels, 10 math channels, 50 communication channels at a Recording interval of 1 s and a data length of 2 h

$$\begin{aligned} & (30 \times 6 \text{ bytes} + 10 \times 6 \text{ bytes} + 50 \times 6 \text{ bytes} + 16 \text{ bytes}) \times 2 \text{ h} \times 60 \times 60 / 1 \text{ s} \\ & = 556 \text{ bytes} \times 2 \text{ h} \times 60 \times 60 / 1 \text{ s} \\ & = 4,003,200 \text{ bytes} \end{aligned}$$

Display Data

Data size per sample × saving interval / recording interval

The recording interval is determined by dividing the trend interval (in seconds) by 30 (50 if the trend interval is 5 s or 10 s).

Example 3: When recording the display data for 30 I/O channels, 10 math channels, and 50 communication channels at a trend interval of 30 min/div (the recording interval of display data is 60 s), and a saving interval of 1 day (24 h)

$$\begin{aligned} & (30 \times 12 \text{ bytes} + 10 \times 12 \text{ bytes} + 50 \times 12 \text{ bytes} + 16 \text{ bytes}) \times 24 \text{ h} \times 60 \times 60 / 60 \text{ sec} \\ & = 1,096 \text{ bytes} \times 24 \text{ h} \times 60 \times 60 / 60 \text{ sec} \\ & = 1,578,240 \text{ bytes} \end{aligned}$$

Size per File

The size per file is the sum of the size of information other than the sampled data and the size of the sampled data and the size of system information.

Event Data

Example 4: When recording under the conditions of examples 1 and 3

From examples 1 and 3, we obtain $40,904 + 4,003,200 = 4,044,104$ bytes = 3.857 MB
Then, add the size of system information (about 5 KB in this example).

Display Data

Example 5: When recording under the conditions of examples 1 and 2

From examples 1 and 2, we obtain $40,904 + 1,578,240 = 1,619,144$ bytes = 1.544 MB
Then, add the size of system information (about 5 KB in this example).

Save Duration to the SD Card

We will estimate the duration over which measured data can be saved to an SD card when measured data is being saved automatically.

Event Data

Save duration to an SD card (estimate) = (Size of the SD card/size per file) × [data length]

Example 7: We will estimate the time until the SD card needs to be replaced under the conditions of examples 1 and 3. In this example, the size of the SD card is assumed to be 1 GB.

1 GB/3.857 MB × 2 h
 1024 MB/3.857 bytes × 2 h
 ≈ 531 h
 ≈ 22.1 days

Display Data

Save duration to an SD card (estimate) = (Size of the SD card/size per file) × [file save interval]

Example 6: We will estimate the save duration to an SD card under the conditions of examples 1 and 2. In this example, the size of the SD card is assumed to be 1 GB.

1 GB/1.544 MB × 24 h
 1024 MB/1.544 bytes × 24 h
 ≈ 15,915 h
 ≈ 663 days

Note

The available size of an SD card is somewhat less than the size indicated.

Time until the Internal Memory Becomes Full

If you are manually saving the measured data in the internal memory, old data is overwritten when the internal memory is full. The maximum number of files that can be saved to the internal memory is 500 on the GM10-1 and 1000 on the GM10-2. Depending on the file size, files may be overwritten before the internal memory becomes full. You need to save the measured data to the SD card before the data is overwritten.

Event Data

Time until the internal memory becomes full (estimate) = (Size of the internal memory/size per file) × [data length]

Example 9: We will estimate the time until the internal memory becomes full under the conditions of examples 1 and 3.

The internal memory is standard (500 MB).

500 MB/3.857 bytes × 2 h
 ≈ 253 h
 ≈ 10.5 days

Display Data

Time until the internal memory becomes full (estimate) = (Size of the internal memory/size per file) × [file save interval]

Example 8: We will estimate the time until the internal memory becomes full under the conditions of examples 1 and 2.

The internal memory is standard (500 MB).

500 MB/1.544 bytes × 24 h
 ≈ 7,771 h
 ≈ 323 days

Appendix 2 Types of Data Files That the GM Can Create and How They Can Be Used

This section will explain the types of data files that the GM can create and how they can be used.

- If you are using the advanced security function (/AS option), see the Advanced Security Function User's Manual (IM 04L55B01-05EN).

Data Type	Extension	Format	Display Method ¹		
			GM	Viewer	Application
Event data	GEV	Binary (undisclosed)	Yes	Yes	Yes ^{2, 3}
	GTE	Text format (TSV)	—	—	Yes
Display data	GDS	Binary (undisclosed)	Yes	Yes	Yes ^{2, 3}
	GTD	Text format (TSV)	—	—	Yes
Report data	GRE	Text (see appendix 3)	—	Yes	Yes
	xlsx	Excel format	—	—	Yes
	xlsm	Excel format (with macro)	—	—	Yes
	pdf	PDF format	—	—	Yes
Manual sampled data	GMN	Text (see appendix 3)	—	Yes	Yes
Setting parameters	GNL	Text	—	—	—
Alarm summary data	GAL	Text format	—	—	Yes
Health monitor log data	GHL	Text format	—	—	Yes

- 1 Viewer: Universal Viewer, Application: Software application
- 2 You can use Universal Viewer to convert the data format and use the converted data on a software application such as Microsoft Excel.
- 3 You can display data loaded from the GM using the communication function on a software application.

Appendix 3 Text File Data Format

This section explains the format of text files. The text files that the GM can create are display and event data files (when the data save format is text), manual sample data files, report files, and alarm summary files. Files contain values and character strings, each separated by a tab, in text format.

Format of Event and Display Data Files

Format

```

YREC
Measure Data      Version 1.01.03
Model            GM10
Language Code    UTF-8
Serial No.       SSS***S
Time Correction   Done
                 None
Sampling Interval NNN***N  ms
                 s
                 min

Trigger Point     NNN***N
Equip Tag        SSS***S
Equip TagNo.     SSS***S
File Header      SSS***S
File ID          NNN***N  NNN***N
Start Info       Unknown  None      SSS***S
                 Manual   Key
                 Auto    Communication
                 Black Out Remote
                 Trigger  Event
End Info         Unknown  None      SSS***S
                 Manual   Key
                 Auto    Communication
                 Black Out Remote
                 Trigger  Event
Extra Data       Meas    Max      PlusOver  NNN***N  ...
                 Math    Min      MinusOver
                 Ext     Inst
Time Zone        NNN***N
DST              On       January  FirstWeek Sunday  NNN***N  January  FirstWeek Sunday  NNN***N  NNN***N
                 Off      February SecondWeek Monday
                 March    ThirdWeek Tuesday
                 April   FourthWeek Wednesday
                 May     LastWeek  Thursday
                 June    Friday
                 July    Saturday
                 August
                 September
                 October
                 November
                 December

Batch Info       NNN***N  SSS***S
Batch Comment    TTT***T  SSS***S  SSS***S
Batch Comment    TTT***T  SSS***S  SSS***S
Batch Comment    TTT***T  SSS***S  SSS***S
Text Info
Text Field       SSS***S  SSS***S
Text Field       SSS***S  SSS***S
Text Field       SSS***S  SSS***S
:
:
:
Text Field       SSS***S  SSS***S
Ch               SSS***S  SSS***S  ...  Message
Ch Id            SSS***S  SSS***S  ...
Tag              SSS***S  SSS***S  ...
Unit             SSS***S  SSS***S  ...
Type            Meas    Meas    ...  Message
                 Math    Math    ...
                 Ext     Ext     ...

Kind            Inst    Inst    ...
                 Min    Min    ...
                 Max    Max    ...

Sampling Data   TTT***T  NNN***N  NNN***N  NNN***N  ...
Message Data

```

Continued on next page

Appendix 3 Text File Data Format

TTT...T SSS...S None SSS...S

Key
 Communication
 Remote
 Event
 System
 Serial
 External
 Web

NNN...N: Number
 SSS...S: Character string
 TTT...T: Date and time

Common header	YREC	Fixed character string
Format header	Measure Data	File type
	Model	Model name
Information header section	Language Code	—
	Serial No.	Serial number (up to 16 characters)
	Time Correction	Time change information
	Sampling Interval	Sampling interval
	Trigger Point	Trigger point: 0 and higher
	Equip Tag	Equipment tag (up to 32 characters)
	Equip TagNo.	Equipment tag number (up to 16 characters)
	File Header	File header (up to 50 characters)
	File ID	First: Record start number Second: File serial number up to record stop First file: 1 and higher
	Start Info	Start user name (up to 20 characters)
	End Info	End user name (up to 20 characters)
	Extra Data	—
	Time Zone	Current time zone setting
	DST	Current DST setting
Batch Info	Lot number: 0 and higher	
	Batch number (up to 32 characters)	
	The entire block is omitted when batch is set to off.	
Batch Comment	User name (up to 20 characters), comment (up to 50 characters)	
Text Info	The entire block is omitted when batch is set to off.	
Text Field	Title (up to 20 characters), text (up to 30 characters)	
Table header section	Ch	Channel number (up to 4 characters) The character string “Message” is inserted at the right end.
	Ch Id	Tag number (up to 16 characters, spaces on the right)
	Tag	Tag name (up to 32 characters, spaces on the right)
	Unit	Unit name (up to 6 characters, spaces on the right)
	Type	The character string “Message” is inserted at the right end.
Kind	The character string “Count” is inserted at the right end.	
	Sampling Data	The number of messages (up to 4 characters) is inserted in the right most column.
Measured data block	Message Data	Message string (up to 32 characters), user name (up to 20 characters) If the number of messages is zero, the entire block is omitted.

File Output Example
• Event data

```

YREC
Measure Data      Version 1.01.03
Model            GM10
Language Code    UTF-8
Serial No.       S5E701635
Time Correction   None
Sampling Interval 500                ms
Trigger Point    4
Equip Tag        tag
Equip TagNo.     tagno
File Header      FILE_HEADER_STRING
File ID          6893290432
Start Info       Auto                Key      Admin
End Info         Auto                Key      Admin
Extra Data       Meas             Inst     PlusOver  999999999 MinusOver -999999999
Extra Data       Math             Inst     PlusOver  999999999 MinusOver -999999999
Extra Data       Ext              Inst     PlusOver  999999999 MinusOver -999999999
Time Zone        540
DST              On
Ch               0001           March     SecondWeek Sunday 2      November FirstWeek Sunday 2 -60
Ch Id            TagID_001     TagID_002 TagID_003 TagID_004
Tag              Furnace 1     Furnace 2 Furnace 3 Furnace 4
Unit             °C            °C        °C        °C
Type             Meas          Meas      Meas      Meas      Message
Kind             Inst          Inst       Inst       Inst       Count

Sampling Data
2012/12/12 14:50:00_000 153.2      153.3      153.2      153.3      1
2012/12/12 14:50:00_500 153.3      153.4      153.3      153.4      0
2012/12/12 14:50:01_000 153.4      153.5      153.4      153.5      2
2012/12/12 14:50:01_500 153.5      153.6      153.5      153.6      0
2012/12/12 14:50:02_000 153.6      153.7      153.6      153.7      0

Message Data
2012/12/12 14:50:01_000 Message 2   Communication Admin2
    
```

Appendix 3 Text File Data Format

• **Display data**

```

YREC
Measure Data      Version 1.01.02
Model             GM10
Language Code    UTF-8
Serial No.       S5E701635
Time Correction   None
Sampling Interval 1                s
Trigger Point    4
Equip Tag        tag
Equip TagNo.    tagno
File Header     FILE_HEADER_STRING
File ID        34295620394          1
Start Info     Auto              Key          Admin
End Info       Auto              Key          Admin
Extra Data     Meas              Max          PlusOver   999999999  MinusOver  -999999999
Extra Data     Meas              Min          PlusOver   999999999  MinusOver  -999999999
Extra Data     Math              Max          PlusOver   999999999  MinusOver  -999999999
Extra Data     Math              Min          PlusOver   999999999  MinusOver  -999999999
Extra Data     Ext              Max          PlusOver   999999999  MinusOver  -999999999
Extra Data     Ext              Min          PlusOver   999999999  MinusOver  -999999999
Time Zone      540
DST            On              March       SecondWeek Sunday 2          November   FirstWeek Sunday 2          -60
Batch Info     000002          batch-name-no.
Batch Comment  2012/12/12     Admin1      comment1
              14:50:00
Batch Comment  2012/12/12     Admin1      comment2
              14:50:00
Batch Comment  2012/12/12     Admin1      comment3
              14:50:00

Text Info
Text Field    title1          text1
Text Field    title2          text2
Text Field    title3          text3
Text Field    title4          text4
Text Field    title5          text5
Text Field    title6          text6
Text Field    title7          text7
Text Field    title8          text8
Text Field    title9          text9
Text Field    title10         text10
Text Field    title11         text11
Text Field    title12         text12
Text Field    title13         text13
Text Field    title14         text14
Text Field    title15         text15
Text Field    title16         text16
Text Field    title17         text17
Text Field    title18         text18
Text Field    title19         text19
Text Field    title20         text20
Text Field    title21         text21
Text Field    title22         text22
Text Field    title23         text23
Text Field    title24         text24
Ch           0001          0001        A001        A001        C002        C002        Message
Ch Id       TagID_001     TagID_001   TagID_002   TagID_002   TagID_003   TagID_003
Tag         Furnace 1     Furnace 1   Furnace 2   Furnace 2   Furnace 3   Furnace 3
Unit        °C            °C            °C            °C            °C            °C
Type        Meas          Meas          Math          Math          Ext          Ext          Message
Kind        Min           Max           Min           Max           Min           Max          Count

Sampling Data
2012/12/12 14:50:00 153.2          153.3          153.2          153.3          153.2          153.3          1
2012/12/12 14:50:01 153.3          153.4          153.3          153.4          153.3          153.4          0
2012/12/12 14:50:02 153.4          153.5          153.4          153.5          153.4          153.5          2
2012/12/12 14:50:03 153.5          153.6          153.5          153.6          153.5          153.6          0
2012/12/12 14:50:04 153.6          153.7          153.6          153.7          153.6          153.7          0

Message Data
2012/12/12 14:50:02 Message 2      Communication Admin2
    
```

Format of Manual Sample Data Files

- Manual sample data files contain values and character strings, each separated by a tab, in text format.
- Values of I/O channels set to **Skip** and math and communication channels set to **Off** are not output.
- The data is appended to the file each time manual sample operation is performed.

Format

```

YREC
Manual Sample Data Version 1.04.00
Language Code UTF-8
Model GM10
File Status Complete
Progress
Decrease

Serial No. SSS...S
Equip Tag SSS...S
Equip TagNo. SSS...S
File Header SSS...S
Extra Data (omitted) Inst PlusOver NNN...N MinusOver NNN...N
Time Zone NNN...N
DST On
Off
January FirstWeek Sunday NNN...N January FirstWeek Sunday NNN...N NNN...N
February SecondWeek Monday February SecondWeek Monday
March ThirdWeek Tuesday March ThirdWeek Tuesday
April FourthWeek Wednesday April FourthWeek Wednesday
May LastWeek Thursday May LastWeek Thursday
June Friday June Friday
July Saturday July Saturday
August
September
October
November
December

Ch SSS...S ...
Ch Id SSS...S ...
Tag SSS...S ...
Unit SSS...S ...
TTT...T NNN...N ...
    
```

NNN...N : Number
 SSS...S : Character string
 TTT...T : Date and time

File Output Example

```

YREC
Manual Sample Data Version 1.04.00
Language Code UTF-8
Model GM10
File Status Progress
Serial No. S5KC09223
Equip Tag tag
Equip TagNo. tagno
File Header
Extra Data Inst PlusOver 999999999 MinusOver -999999999
Time Zone 540
DST On February SecondWeek Sunday 20 September ThirdWeek 20 -60
Ch 0001 0002 0003 0004 0005 0006 0007 0008
Ch Id chid001001 chid001002 chid001003 chid001004 chid001005 chid001006 chid001007 chid001008
Tag
Unit V V V V V V V V
2012/12/12 14:50:01 0 0 -0.0001 -0.0003 -0.0005 -0.0007 -0.0009 -0.0002
2012/12/12 14:51:01 0 0 -0.0002 -0.0004 -0.0006 -0.0008 -0.0001 -0.0003
    
```

Note

- File status
 Complete: Completed (100 manual sample data entries have been stored, and the file is closed.)
 Progress: Progress: Data is being added. (The number of stored data entries has not reached 100 files, and the file is open.)
 Decrease: Corrupted. (Some of the manual sample data in the file are missing.)
- Output when channel data is in the condition shown in the table below

Data Condition	Data Handling	Output
Error	Error	(Space)
+Overrange	+Over	Value indicated for PlusOver in the Extra Data information header section
Burnout		
+Display over		
+Computation over		
-Overrange	-Over	Value indicated for MinusOver in the Extra Data information header section
-Burnout		
-Display over		
-Computation over		

- A new manual sampled data file is created in the following cases.
- The range of an I/O channel configured as a manual sampling recording channel was changed from some range other than **Skip** to **Skip**.
- The range of an I/O channel configured as a manual sampling recording channel was changed from **Skip** to some range other than **Skip**.
- A math or communication channel configured as a manual sampling recording channel was changed from **On** to **Off** or from **Off** to **On**.
- The unit of a channel configured as a manual sampling recording channel was changed.
- When the settings of a manual sampling recording channel are changed.
- When an AI channel configured as a manual sampling recording channel is changed from the **DI** range (calculation is not set to linear scaling) to some other range, or vice versa.
- When a DI channel configured as a manual sampling recording channel is changed from linear scaling calculation to some other setting, or vice versa.
- When the decimal place of a channel configured as a manual sampling recording channel is changed.

Report File Format (/MT option)

- Hourly, daily, weekly, and monthly report files contain values and character strings, each separated by a tab, in text format.
- Values of I/O channels set to **Skip** and math and communication channels set to **Off** are not output.
- The data is appended to this file every time a report is created.

Format

```

YREC
Report Data      Version 1.04.00
Language Code    UTF-8
Model            GM10
File Statas      Complete
                  Progress
                  Decrease
Serial No.        SSS...S
Equip Tag        SSS...S
Equip TagNo.     SSS...S
File Header      SSS...S
Extra Data        (omitted)      Ave      PlusOver  NNN...N      MinusOver  NNN...N
                  Max
                  Min
                  Sum
                  Inst
Report Set        Hourly+Daily
                  Daily+Weekly
                  Daily+Monthly
                  Batch
                  DailyCustom
File Data         Hourly
                  Daily
                  Weekly
                  Monthly
                  Hourly+Daily
                  Daily+Weekly
                  Daily+Monthly
                  Batch
                  DailyCustom
Math Set          Ave      ...
                  Max
                  Min
                  Sum
                  Inst
Start Time        TTT...T
Time Zone         NNN...N
DST               On          January  FirstWeek  Sunday  NNN...N  January  FirstWeek  Sunday  NNN...N  NNN...N
                  Off          February  SecondWeek Monday    February  SecondWeek Monday
                  March    ThirdWeek  Tuesday   March    ThirdWeek  Tuesday
                  April   FourthWeek Wednesday  April   FourthWeek Wednesday
                  May     LastWeek   Thursday  May     LastWeek   Thursday
                  June   June       Friday    June   June       Friday
                  July    July       Saturday  July    July       Saturday
                  August  August
                  September
                  October
                  November
                  December
Ch                SSS...S      ...
Ch Id             SSS...S      ...
Tag              SSS...S      ...
Unit             SSS...S      ...
Data Type        Free
                  Hourly
                  Daily
                  Weekly
                  Monthly
                  Batch
                  DailyCustom
Time             TTT...T
Elapsed Time*    (omitted)    TTT...T
Status           Bo      ...
                  Er
                  Ov
                  Pw
                  Cg
(Data attribute  NNN...N      ...
identifier)
    
```

Appendix 3 Text File Data Format

NNN...N: Number
 SSS...S: Character string
 TTT...T: Date and time
 * Elapsed time is used for batch reports.

Output Example

- Hourly (hourly + daily) recording with file set to Separate

```

YREC
Report Data Version 1.04.00
Language Code UTF-8
Model GM10
File Statas Complete
Serial No. S5KC09223
Equip Tag tag
Equip TagNo. tagno
File Header
Extra Data Ave PlusOver 999999999 MinusOver -999999999
Extra Data Max PlusOver 999999999 MinusOver -999999999
Extra Data Min PlusOver 999999999 MinusOver -999999999
Extra Data Inst PlusOver 999999999 MinusOver -999999999
Report Set Hourly+Daily
File Data Hourly
Math Set Ave Max Min Sum
Start Time 2012/12/12 11:01:01
Time Zone 540
DST On February SecondWeek Sunday 20 September ThirdWeek 20 -60
Ch 0001 0002 0003 0004 A001 A002 A003 C001
Ch Id chid001001 chid001002 chid001003 chid001004 chid001005 chid001006 chid001007 chid001008
Tag Point A Point B Point C Point D Point A Math Point B Math Point C Math Com
Unit V V V V 'C 'C 'C V
Data Type Hourly
Time 2012/12/12 12:00:00
Status
Ave 0.0001 0.5010 0.7397 -1.0001 122.6 20.08 -20.98 0.2001
Max 1.9983 0.9989 1.4995 0.0010 123.4 22.02 -20.01 0.8887
Min -1.9959 -0.0053 -0.1005 -1.9952 120.3 19.79 -24.00 -0.3345
Sum 0.353900E+00 1.773039E+03 2.617798E+03 -3.53935E-03 4.338814E+05 7.099234E+04 -7.424822E-04 7.081539E+02
Data Type Hourly
Time 2012/12/12 12:06:01
Status
Ave 0.0002 0.5011 0.3301 -1.4423 121.3 20.20 -21.21 0.4411
Max 1.9984 0.9990 1.4995 0.0001 122.4 21.98 -20.95 0.8898
Min -1.9959 -0.0055 -1.4005 -1.994 120.09 19.00 -22.22 -0.1121
Sum 0.072200E+00 1.808971E+02 1.191661E+02 -5.206703E-02 4.378930E+04 7.292200E+03 -7.656810E-03 1.592371E+02
  
```

• Batch Report

```

YREC
Report Data Version 1.04.00
Language Code UTF-8
Model GM10
File Status Complete
Serial No. S5KC09223
Equip Tag tag
Equip TagNo. tagno
File Header
Extra Data Ave PlusOver 999999999 MinusOver -999999999
Extra Data Max PlusOver 999999999 MinusOver -999999999
Extra Data Min PlusOver 999999999 MinusOver -999999999
Extra Data Inst PlusOver 999999999 MinusOver -999999999
Report Set Batch
File Data Batch
Math Set Ave Max Min Sum
Start Time 2012/12/12 11:01:01
Time Zone 540
DST On February SecondWeek Sunday 20 September ThirdWeek 20 -60
Ch 0001 0002 0003 0004 A001 A002 A003 C001
Ch Id chid001001 chid001002 chid001003 chid001004 chid001005 chid001006 chid001007 chid001008
Tag
Unit V V V V °C °C °C V
Data Type Batch
Elapsed Time 0000 00:10:00
Status
Ave 0.0001 0.5010 0.7397 -1.0001 122.6 20.08 -20.98 0.2001
Max 1.9983 0.9989 1.4995 0.0010 123.4 22.02 -20.01 0.8887
Min -1.9983 -0.0033 -0.1005 -1.9952 120.3 19.79 -24.00 -0.3345
Sum 6.000000E-02 3.006000E+02 4.438200E+02 -6.000600E+02 7.356000E+04 1.204800E+04 -1.258800E+04 1.206000E+02
Data Type Batch
Elapsed Time 0000 00:15:30
Status
Ave 0.0021 0.5110 0.7362 -1.0005 98.5 20.51 -20.42 0.1999
Max 1.9950 0.9987 1.4991 0.0011 105.2 21.01 -19.99 0.8802
Min -1.9989 -0.0053 -0.0997 -1.9960 70.5 20.01 -23.89 -0.3321
Sum 6.930000E+00 1.818300E+02 2.429460E+02 3.301650E+02 3.250500E+04 6.768300E+03 -6.738600E+03 6.596700E+01
Data Type Free
Elapsed Time 0000 00:15:30
Status
Ave 0.0008 0.5187 0.7374 -1.0002 114.0 20.23 -20.78 0.2000
Max 1.9950 0.9989 1.4995 0.0011 123.4 22.02 -19.99 0.8887
Min -1.9989 -0.0053 -0.1005 -1.9952 70.5 19.79 -24.00 -0.3345
Sum 7.530000E-01 4.824300E+02 6.858210E+02 -9.3022500E+02 1.060650E+05 1.881630E+04 -1.932660E+04 1.860270E+02
    
```

Alarm Summary Format

- Files contain values and character strings, each separated by a tab, in text format.
- Values of I/O channels set to **Skip** and math and communication channels set to **Off** are not output.

Format

```

YREC
Alarm Summary Data Version 1.01.00
Language Code      UTF-8
Model              GM10
Serial No.         SSS...S
Equip Tag          SSS...S
Equip TagNo.      SSS...S
File Header       SSS...S
Time Zone         NNN...N
DST               On      January      FirstWeek  Sunday      NNN...N  January      FirstWeek  Sunday      NNN...N  NNN...N
                  Off     February     SecondWeek Monday      February     SecondWeek Monday
                  March     ThirdWeek  Tuesday      March        ThirdWeek  Tuesday
                  April     FourthWeek Wednesday    April        FourthWeek Wednesday
                  May       LastWeek   Thursday     May          LastWeek   Thursday
                  June     Friday     Saturday     June         Friday
                  July     Saturday   July         Saturday     July         Saturday
                  August
                  September
                  October
                  November
                  December
December

Alarm Data
TTT...T          On      SSS...S      SSS...S      SSS...S
                  Off
                  Ack
    
```

NNN...N : Number
 SSS...S : Character string
 TTT...T : Date and time

Output Example

```

YREC
Alarm Summary Data Version 1.01.00
Language Code      UTF-8
Model              GM10
Serial No.         SSKC09223
Equip Tag          tag
Equip TagNo.      tagno
File Header
Time Zone         540
DST               On      February     SecondWeek  Sunday      20      September  ThirdWeek  20      -60
Alarm Data
2012/12/12 11:01:10 On      0001         1           H
2012/12/12 11:01:12 Off     0001         1           H
2012/12/12 11:01:14 Ack     All
    
```

Health Monitor Log Format

- Files contain values and character strings, each separated by a tab, in text format.

Format

```

YREC
HealthLog Data   Version 1.01.00
Model            GM10
Language Code    UTF-8
Serial No.       SSS...S
Sampling Interval NNN...N      ms
                                   s
                                   min
Equip Tag        SSS...S
Equip TagNo.     SSS...S
File Header      SSS...S
Time Zone        NNN...N
DST              On      January      FirstWeek  Sunday  NNN...N  January      FirstWeek  Sunday  NNN...N  NNN...N
                Off     February     SecondWeek Monday
                March     ThirdWeek  Tuesday
                April     FourthWeek Wednesday
                May       LastWeek   Thursday
                June     Friday
                July      Saturday
                August
                September
                October
                November
                December
HealthLog
TTT...T         TTT...T   SSS...S   OK      NNN...N
                                   NG
    
```

NNN...N : Number
 SSS...S : Character string
 TTT...T : Date and time

Output Example

```

YREC
HealthLog Data   Version 1.01.00
Model            GM10
Language Code    UTF-8
Serial No.       S5W456789
Sampling Interval 2      s
Equip Tag        tag
Equip TagNo.     tagno
File Header
Time Zone        540
DST              On      March      SecondWeek Sunday  2      November  FirstWeek  2      -60
HealthLog
2021/7/23 11:01  2021/7/23 12:01  Model1.GDG  OK      1.001
2021/7/23 12:01  2021/7/23 13:01  Model1.GDG  OK      0.758
2021/7/23 13:01  2021/7/23 14:01  Model1.GDG  NG      -0.154
    
```

Appendix 4 Creating Report Templates

Creating Report Templates for Report Files in Excel Format

To create a report template, enter keywords and text in the cells of an Excel file. Keywords specify the type of data that will be entered into a cell. Text are output as they are in reports. Save the report templates that you create in Excel format (.xlsx extension) or Excel macro format (.xlsm extension).

- ▶ Function: See page 2-129 in section 2.18, "Using the Report Template Function (/MT option)".
- ▶ Setup: See page 2-124 in section 2.17, "Configuring the Report Function (/MT option)".
- ▶ Loading and saving report templates: See page 2-195 in section 2.28.3, "Saving and Loading Report Templates (/MT option)".

Template Example

Channel number	\$Tag(R001)\$	\$Tag(R002)\$
Name	Tank 1 temperature	Tank 1 pressure
Unit	\$Unit(R001)\$	\$Unit(R002)\$
\$ReportDataTime(Hour)\$	\$ReportDataInst(Hour, R001)\$	\$ReportDataInst(Hour, R002)\$
\$Repeat\$	\$Repeat\$	\$Repeat\$
\$Repeat\$	\$Repeat\$	\$Repeat\$

Report Output Example

Channel number	TIC-001	PIC-002
Name	Tank 1 temperature	Tank 1 pressure
Unit	°C	kPa
2012/12/01 00: 00: 00	76.5	45.6
2012/12/01 01: 00: 00	78.9	56.7
2012/12/01 02: 00: 00	77.7	50.8

Keyword Format

Keywords are written by themselves or with parameters.

`$ Keyword(parameter)$` Example: `$ReportDataSum(Hour,R001,00,23)$`

Basic Rules

- The dollar sign on the left indicates the start of a keyword, and the dollar sign on the right indicates the end of a keyword.
- You can only write keywords using letters of the alphabet, dollar signs, parentheses, commas, and spaces. You can put a space after an opening parenthesis, before and after a comma, and before a closing parenthesis. Keywords are not case sensitive. You cannot use a dollar sign inside of a keyword.
- The maximum length of a keyword, including spaces, is 100 characters.

Parameter Rules

- Parameters are enclosed in parentheses.
- Multiple parameters (up to 4) are separated by commas.
- Examples of how parameters can be omitted are shown below.

`$ReportDataSum(Hour, R001, ,23)$` The third parameter has been omitted.
`$ReportDataSum(Hour, R001, 01,)$` or `$ReportDataSum(Hour, R001, 01)$` The fourth parameter has been omitted.

Excel Format Rules

- Set the data format by setting the cell format.
- Set the proper format for each keyword's cell in the cell's Number properties.
- The keyword in a cell is only valid when the keyword name and parameters are all in the same format. When a keyword's font size or some other property is not consistent, it is invalid.

`$ReportDataSum(Hour, R001, 00, 23)$` The font size of "Hour" is different, so the keyword is invalid.

- If a single cell contains text and a keyword, only the format of the keyword has to be consistent. The format of the text can be different.

Date and time: `$DateTime$` The format of the keyword is consistent, so it is valid.

Limitations on Report Types and Template Types

If you violate the rules illustrated below, data will not be output.

Keyword Parameter	Template Type								
	Hour	Day	Week	Month	Hour + Day	Day + Week	Day + Month	Batch Report	Day Custom
Hour	✓				✓				
Day		✓			✓	✓	✓		
Week			✓			✓			
Month				✓			✓		
Batch								✓	
Custom									✓
Free								✓	✓

Limitation on Report Types and Parameter Omissions

If you violate the rules illustrated below, it will be considered a keyword format error. The keyword will not be converted and will remain as is.

Report Kind	Start date and time	End date and time	Start number	End number
Hour	Start time (hour)	End time (hour)	—	—
Day	Start day	End day	—	—
Week	—	—	—	—
Month	—	—	—	—
Batch	Relative start time (minute)	Relative end time (minute)	Start number	End number
Custom	Start time (hour:minute)	End time (hour:minute)	—	—
Free	—	—	—	—

Keyword Definitions

For examples, see “Report Template Examples.”

• System Keywords

One keyword produces one item of data.

Keyword	Description	Format
Time	Current time on the GM	Time ²
Date	Current date on the GM	Date ²
DateTime	Current date and time on the GM	
DateTimeString	Current date and time on the GM	Character string
Serial	GM serial number	
Equip Tag	GM Tag string	
EquipTagNo	GM Tag number	
FileHeader	GM file header	
Ch	Channel number ¹	
Tag	Tag string ¹	
ChId	Tag number ¹	
Unit	Unit ¹	

1 The parameter is the report channel number (it cannot be omitted).

2 The item becomes a character string in PDF and printer output.

• Report Data Keywords

One keyword produces multiple items of data.

Keyword	Description	Format
ReportDataDate	Report creation date ¹	Date ⁵
ReportDataTime	Report creation time ¹	Time ⁵
ReportDataDateTime	Report creation date and time ¹	Date ⁵
ReportDataDateTimeString	Report creation date and time ¹	Character string
ReportDataElapsedTimeString ⁴	Report data time out date and time	
ReportDataStatus	Report data status ²	
ReportDataSum	Report data sum ²	Number or character string ³
ReportDataInst	Instantaneous report data value ²	
ReportDataAve	Average report data value ²	
ReportDataMax	Maximum report data value ²	
ReportDataMin	Minimum report data value ²	

1 Write the parameters in this order: report type (cannot be omitted), report start date and time (can be omitted), report end date, time (can be omitted), start number (can be omitted), and end number (can be omitted).

2 Write the parameters in this order: report type (cannot be omitted), report channel number (cannot be omitted), report start date and time (can be omitted), report end date and time (can be omitted), start number (can be omitted), and end number (can be omitted).

3 The decimal point type (dot or comma) depends on whether the converted data is a value or character string. Whether the converted data is a value or character string depends on the format of the cell that the keyword is written in. When the cell format is numerical, the decimal point type is determined by the cell format. When the cell format is text, the decimal point type matches the format of the report data.

4 Valid only when the report type is **Batch**.

5 The item becomes a character string in PDF and printer output.

• Special Keywords

Keyword	Description	Format
Repeat	Specifies the output location of the data that corresponds the report data keyword and the Index keyword (a special keyword).	The same as the corresponding keyword.
Copy	Outputs all data that corresponds the report data keyword and the Index keyword (a special keyword). This keyword is valid for PDF and printer output.	The same as the corresponding keyword.
Index	Outputs serial numbers from the value specified by “start” to the value specified by “end.”	Number

Appendix 4 Creating Report Templates

• **Parameter**

Parameter Name	Format	Range	Description	Notes
Report channel number	Rxxx ¹	R001 to R100	GM report channel	
Report Kind	Hour	—	Hourly report	
	Day	—	Daily report	
	Week	—	Weekly report	
	Month	—	Monthly report	
	Batch	—	Batch report	
	Custom	—	Daily custom	
	Free	—	Batch and daily custom reports Computed results, such as sum values, of data in the file are appended to the file. This piece of data is called "Free."	
Start date and time	hh ²	00 to 23	Specifies the start hour	Used in hourly reports
	dd ³	01 to 31	Specifies the start day	Used in daily reports
	mm ⁴	0 to 12000	Specify the start minute	Used in batch reports
	hh:mm ⁵	hh: 00 to 23 mm: 00 to 59	Specifies the start hour:time	Used in hourly custom reports
End date and time	hh ²	00 to 23	Specifies the end hour	Used in hourly reports
	dd ³	01 to 31	Specifies the end day	Used in daily reports
	mm ⁴	0 to 12000	Specify the end minute	Used in batch reports
	hh:mm ⁵	hh: 00 to 23 mm: 00 to 59	Specifies the end hour:minute	Used in hourly custom reports
Start number	xxx ¹	001 to 200	Specifies the start number	Used in batch reports
End number	xxx ¹	001 to 200	Specifies the end number	Used in batch reports

- 1 xxx is a number without a limitation on the number of digits
- 2 hh is a number without a limitation on the number of digits
- 3 dd is a number without a limitation on the number of digits
- 4 mm is a number without a limitation on the number of digits
- 5 Spaces are allowed before and after colons.
- 6 Start time and end time are relative to the record start time.

Starting and Ending Dates and Times

Use the start date and time and end date and time to specify the parts of the report file's report data that you will output to the file that you create with the template. You can specify the starting and ending dates (for daily reports) or times (for hourly reports).

Report Kind	Start Date and Time	End Date and Time
Hour	Start time (hour)	End time (hour)
Day	Start time (day)	End time (day)
Batch	Start time (minute)	End time (minute)
Day custom	Start time (hour:minute)	End time (hour:minute)

Example Example when the report type is hourly and the report is created at 18:00.

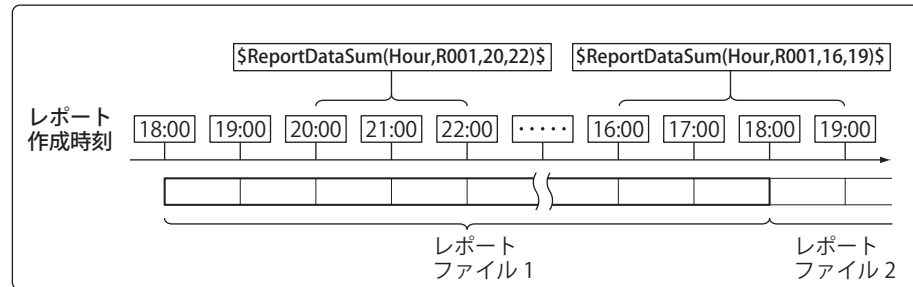

Keyword: `$ReportDataSum(Hour,R001,20,22)$`

From the hourly data from 19:00:01 to 22:00:00, the report data (sums) of report channel R001 for 20:00, 21:00, and 22:00 is output.

Keyword: `$ReportDataSum(Hour,R001,16,19)$`

From the hourly data from 3:00:01 PM to 7:00:00 PM, the report data (sums) of report channel R001 for 4:00 PM, 5:00 PM, and 6:00 PM is output. Because the report data for 19:00 is in another report file, it is not output.

Keyword: `$ReportDataSum(Hour,R001)$`

One file's worth (18:00:01 to 18:00:00) of data from report channel R001 is output, starting from 19:00.

When you omit the start and end times for an hourly report, the data for the hour after the report creation time until the 24th hour is output. For daily reports, the data for the day after the report creation time until the end of the month is output.

Keyword: `$ReportDataSum(Hour,R001,08)$`

From the hourly data from 07:00:01 to 18:00:00, the report data (sums) of report channel R001 for 08:00 to 18:00 is output.

Report Template Examples

System Keyword Examples

Intermixed Keyword and Text

File header: \$FileHeader\$			
Date and time: \$DateTime\$			
File header: GM10			
Date and time: 2012/12/01 12:00:00			

Intermixed Multiple Keyword and Text

Device number: \$Serial\$ File Header: \$FileHeader\$			
Device number: ABCDEFG File Header: GM10			

Report Data Keyword Examples

The following examples are for when the hourly report data for report channel R001 is 101, 102, 103, 104, and 105 and the hourly report data for report channel R002 is 201, 202, 203, 204, 205, and 206.

The \$Repeat\$ command applies to the closest keyword above the command in the same column.

\$ReportDataInst(Hour,R001)\$		101	
\$Repeat\$		102	
\$Repeat\$		103	
\$Repeat\$		104	
\$ReportDataInst(Hour,R002)\$		201	
\$Repeat\$		202	
\$Repeat\$		203	
\$Repeat\$		204	
\$Repeat\$		205	

The \$Repeat\$ command applies to the keyword above it in the same column, even when that keyword is not directly above the command.

\$ReportDataInst(Hour,R001)\$		101	
\$Unit(R001)\$		°C	
\$Repeat\$		102	
\$Unit(R001)\$		°C	
\$Repeat\$	\$Unit(R001)\$	103	°C

You can mix system keywords, report data keywords, and text. If the data specified by a keyword does not exist, nothing is output.

\$ReportDataInst(Hour,R001)\$(\$Unit(R001)\$)		101(°C)	
\$Repeat\$		102	
\$Repeat\$		103	
\$Repeat\$(\$Unit(R001)\$)		104(°C)	
\$Repeat\$(°C)		105(°C)	
\$Repeat\$			

Keywords in merged cells are affected by the leftmost cells above them.

	\$ReportDataInst(Hour,R001)\$	\$ReportDataInst(Hour,R002)\$	
	\$Repeat\$	\$Repeat\$	
\$Repeat\$		\$Repeat\$	
	\$Repeat\$	\$Repeat\$	
	↓		
	101	201	
	102	202	
		203	
	103	204	

When a keyword is written incorrectly or its formatting is wrong, the keyword will be output to the file as it is written.

\$ReportDataInst(Hour,R)\$	\$ReportDataInst(Hour,R)\$
\$ReportDataInst(Hour,R002)\$	201
\$Repeat\$	\$Repeat\$
\$Repeat\$	202
\$Repeat\$	203
\$Repeat\$	204
\$ReportDataInst(Hour,R001)\$	101
\$ReportDataInst(Hour,R002)\$	\$ReportDataInst(Hour,R002)\$

1 When there are multiple system keywords in the same cell, only the first keyword is valid.

Creating Report Templates for PDF Report Files and Printer Output

To create a report template, use the editing tool provided by YOKOGAWA to enter keywords and text in the cells of table.

Keywords specify the type of data that will be entered into a cell. Text are output as they are in reports.

For the keywords that you can use, see “Creating Report Templates for Report Files in Excel Format.”

Appendix 5 Power Recovery Operation

This section explains how the GM operates when it recovers from a power failure.

Power Failure Detection

The GM power shuts down when the power is disrupted for the times indicated below.

- 100 to 240 VAC: 1 cycle or more

Basic Operation

The following operations are retained when the GM recovers from a power failure.

Recording Operation

- If a power failure occurs while the GM is recording, it will continue recording when it recovers.
- Display and event data files are separated when a power failure occurs.

Moving Average

Moving average of AI channels are not retained. When the GM recovers, a new moving average will start.

Timer Action

- Relative timer
Time action is retained. Relative timers do not count the power failure time.
- Absolute timer, match time timer
If timers expire during a power failure, timeout processing occurs when the GM recovers.

Remote

Remote conditions are retained. If remote conditions change during a power failure, the corresponding remote actions are executed when the GM recovers.

Computation

- If a power failure occurs while the GM is computing, it will continue computing when it recovers.
- Computation results are retained during a power failure.
- Rolling average values are also retained during a power failure.
- If absolute timers or match time timers expire during a power failure, TLOG computation is performed when the GM recovers.

Report Operation

- If a power failure occurs while the GM is creating a report, it will continue to create it when it recovers.
- If timers expire during a power failure, timeout processing occurs using the data up to the power failure when the GM recovers. If this occurs, the report data will contain a power failure mark.

Equipment/Quality Prediction

- If a power failure occurs while the predictive detection section is started, it will continue in the start state when it recovers.
- The profile function is disabled until the early warning detection interval stops after recovery.
- The health monitor function cannot calculate the score based on the data before and after a power failure (an error occurs).

Communication Operation

Communication ports are closed when a power failure occurs.

- Reestablish Ethernet connections.
- Client function
 - When Modbus client is in use and a power failure occurs in the middle of a transmission, the data will not be retransmitted.
 - When the FTP client function is in use and a power failure occurs in the middle of a file transfer, the file will be re-transferred when the GM recovers.
- Communication channel values are retained even during a power failure. The GM can be configured so that the values take on preset values when the GM recovers.

DO Operation

DO output values are not retained during a power failure.

- Alarm output
Alarms are set to off when the GM recovers.
- Manual DO operation
Manual DO operation is set to off, regardless of the condition before the power failure.
- Fail operation
Fail operation is set to off, regardless of the condition before the power failure.

Appendix 6 Computation Examples Using Pulse Input

Example 1: Pulse Sum Value

Sum the pulses applied to channel 0001.

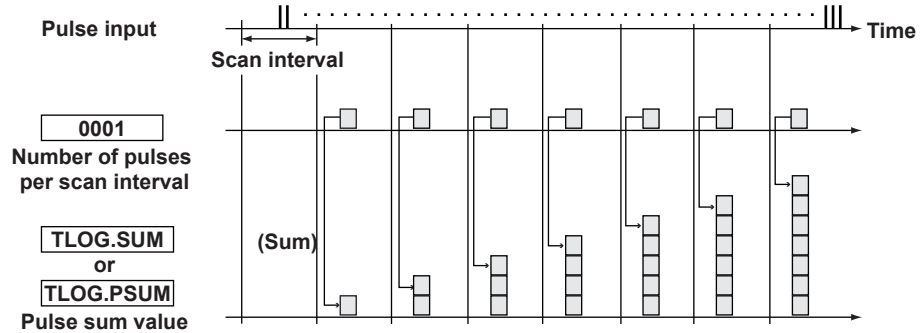

Expression

Assign the computation channel and set the expression. Set the span lower/upper limit and unit according to the application.

Channel	Expression	Description
A001	TLOG.SUM(0001)	Sum of the number of pulses per scan interval
	TLOG.PSUM(0001)	Sum of the number of pulses per scan interval (Only the input channels of GX90XP pulse input modules)

Example 2: Number of Pulses per Minute

With the scan interval set to 1 s,* count the pulse signal applied to 0001, and calculate and display the number of pulses per minute.

* This computation example is not possible for scan intervals faster than 1 s.

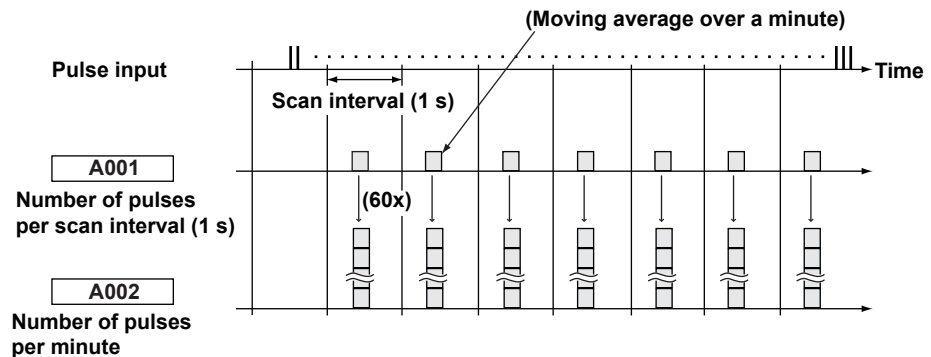

Expression

Assign the computation channel and set the expression. Set the span lower/upper limit and unit according to the application.

Channel	Expression	Description
A001	0001	Number of pulses input to 0001
A002	A001*K001	Number of pulses per minute
Constant	Value	Description
K001	60	Coefficient for converting the number of pulses per second to the number of pulses per minute
Channel	Rolling average	Description
A001	Sampling interval: 1s Number of samples: 60	Moving average over a minute

Channel

The computation is performed in order from the channel with the smallest channel number in one scan interval.

Use a channel of a channel number larger than that of the channel counting the number of pulses per second for the computation channel that is to calculate the number of pulses per minute.

Example 3: Reset When the Pulse Sum Value Exceeds a Certain Value

Reset the sum value when the pulse sum value exceeds a specified value (reset value) and carry over the value exceeding the reset value to the sum after the reset. Count the number of resets and calculate the total sum value up to that point.

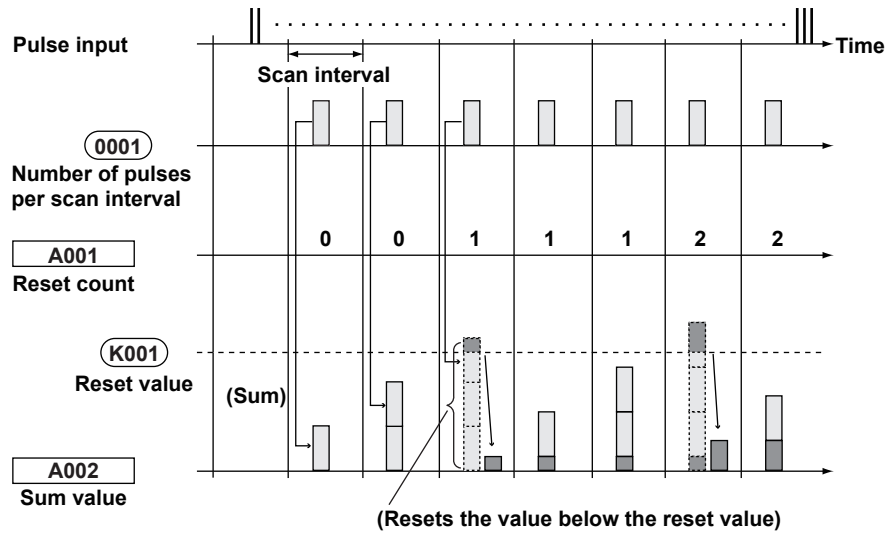

Expression

Assign the computation channel and set the expression. Set the span lower/upper limit and unit according to the application.

Channel	Expression	Description
A001	$((A002+0001).GE.K001)+A001$	Pulse sum value reset count
A002	$CARRY(K001):TLOG.SUM(0001)$	Pulse sum value
A003	$K001*A001+A002$	Total sum value
Constant	Description	
K001	The reset value. The sum value is reset when this value is exceeded.	

Channel A001: Reset Count

Calculates the number of times the pulse sum value is reset. The expression “ $((A002+0001).GE.K001)$ ” is set to 1 when “the previous pulse sum value (A002) + the current pulse count (0001)” is greater than the reset value (K001). Otherwise, the expression is set to 0. The value of channel A001 is incremented when the pulse sum value exceeds the reset value.

Channel A002: Pulse Sum Value

Calculates the pulse sum value. Under normal conditions, the pulse sum value TLOG.SUM (0001) is calculated. When the pulse sum value is greater than or equal to the reset value (K001), the pulse sum value is set to the amount exceeding K001.

Channel A003: Total Sum Value

Multiplies the reset value (K001) by the reset count (A001) and adds the pulse sum value (A002) to derive the total sum value.

Note

- The computation is performed in order from the channel with the smallest channel number in one scan interval. If the channel number in the expression is greater than or equal to the channel number in which the expression is assigned, the previous computed result (previous value) is used for the channel in the expression.
- If the pulse input value of the scan interval is greater than the reset value, correct computation cannot be achieved.

Appendix 7 Terminology

This section explains the terminology related to the GM.

Term	Explanation	Notes
Event data	Measured data that is recorded at the specified recording interval.	
Display data	Measured data that records the maximum and minimum values of the sampled data within the recording interval, which is determined by the specified trend interval.	
Trend interval	The interval at which the waveform display is updated.	▶ page 2-94 in section 2.11.1, "Setting the Trend Interval"
I/O channel	A collective term that refers to analog input channels (AI channels), digital input channels (DI channels), pulse input channels, and digital output channels (DO channels).	
AI channel	Analog input channel. Analog input channels can receive and measure DC voltage, thermocouple (TC), RTD, and On/Off signals (DI).	
DI channel	Digital input channel. Digital input channels can measure On/Off signals.	
Pulse input channel	Input channel of a pulse input module. Pulse input can be integrated by using math (/MT).	
DO channel	Digital output channel. Digital output channels can be used as relay outputs.	
AO channel	Analog output channel. AO channels can output DC current signals (4-20mA, 0-20mA range).	
PID channel	A channel (PV, SP, OUT, AI, DI, AO, or DO) on a PID control module.	
GS (range type)	Range type for 1-5VDC and 0.4-2VDC signals	
GS (4-20mA) (range type)	Range type for 4 to 20 mADC signals (current input modules)	
DI (range type)	Range type for digital input (1, 0) based on contacts or voltage levels	
RTD (range type)	Range type for RTD sensors	
TC (range type)	Range type for thermocouple sensors	
Resistance (range type)	This is a range type for the 4-wire resistance input.	
Input calculation	Calculation performed on inputs, such as scaling, taking the difference between two channels (difference in relation to a reference channel), and square rooting.	
Color scale band	Displays a specified section (inside or outside) of the measurement range using a color band on the scale.	
Trip line	A line displayed at a specified position in the waveform display range on the trend display.	
Zone (display)	Zones enable channels to be displayed in separate areas so that waveforms do not overlap.	
Manual sample	An action executed through a screen operation or event action function. The action saves instantaneous values of all channels (except those set to Skip or Off).	
Reconfiguration	A system reconfiguration that aligns the GM settings to the I/O module configuration. Reconfiguration is necessary when the positions of different types of modules are changed and when modules are added or deleted.	▶ page 2-211 in section 2.29.4, "Reconfiguring the GM"
Individual alarm ACK	The operation of acknowledging alarms (clearing alarm output) separately by channel and level.	
General communication (GENE)	A function for communicating with the GM (configuration and control) using GM dedicated communication commands.	

Index

- 2ch mode 2-100
 10ch mode 2-100
- A**
- relay action on ACK 2-64
 action on math start 2-132
 A/D integration time 1-19
 alarm acknowledge operation 2-65
 alarm delay 2-35, 2-48, 2-54, 2-87
 alarm type 2-33, 2-35
 all alarms, acknowledging 2-65
 AND/OR operation 2-65
 auto increment 2-122
 auto save 1-27, 2-118, 2-119
- B**
- batch function 1-37
 bias 2-31
 binary format 1-28
 burnout 2-31
 burnout criteria 2-103
- C**
- calibration correction 2-43, 2-152
 certificate for communication 2-217
 certificate signature request (CSR) 2-217, 2-219
 collectively storing unsaved data 2-120
 color scale band 2-40, 2-89, 2-151
 continuous data area 4-33
 continuous data read/write area 4-53
 correction factor 2-43, 2-152
- D**
- daily custom 2-126
 DARWIN 2-171, 2-174, 2-221
 data length 2-106
 data save 1-4
 data type 1-4, 1-22, 2-109
 decimal place 2-28, 2-47
 delta 2-52
 detection 2-34, 2-48, 2-86, 2-148
 difference calculation 2-27
 display characters of each value 2-41, 2-50, 2-56, 2-68
 display data 1-23, 2-107, 2-108
 display (Web browser) 1-28
 DO output relay operation 2-66
 dual interval settings 2-112
- E**
- encryption 2-157, 2-158, 2-169, 2-215
 Energize/De-energize 2-64, 2-65
 Equipment/Quality Prediction 1-62, 2-232
 event action 1-33
 event data 1-23, 2-104, 2-108, 3-5
 Excel report files 2-129
 extension 2-117
- F**
- FIFO function 1-27
- file format 2-121
 file save interval 2-107
 file type 2-104
 firmware updating 5-17
 firmware version v
 free 2-105
- G**
- gap between messages 2-175
 GENE 2-170
 grid 2-112, 2-113, 2-114
- H**
- hysteresis 2-34, 2-48, 2-53, 2-86, 2-148
- I**
- individual alarm ACK 2-64, 2-65, 2-183, 3-21
 input measurement, execution 2-44
 instrument correction factor 2-44, 2-152
 intermediate certificate 2-219
 internal memory 1-25
- K**
- key 2-216
- L**
- large memory type i
 linearizer approximation 2-43, 2-45, 2-152, 2-153
 linearizer bias 2-43, 2-45, 2-152, 2-153
 linearizer input 2-43, 2-152
 linearizer output 2-43, 2-152
 linear scaling 2-27, 2-52
 logging 2-53
 login 1-42
 low-cut output 2-28
 low-cut value 2-28
- M**
- manual sample 2-111, 3-5
 manual save 1-27, 2-120
 measurement mode 2-211
 media FIFO 2-118, 2-120
- N**
- Nonhold/Hold 2-65
 normal and remote 2-100
 notes on connecting modules 1-15
- O**
- operation of gradually correcting the internal clock 2-185
 output 1-26
 over range 2-42
- P**
- partial expanded display 2-40
 password initialization 2-190

Index

PC system requirements 2-3
PDF report files..... 2-130
certificate for PDF signature 2-217
PDF electronic signature 2-126
possible combinations of events and actions 1-34
power-fail message 2-96
pre-trigger 2-107

Q

quick setting function 1-70

R

recommended replacement periods for worn parts 5-15
reconfiguration 2-212
recording 1-4, 1-22
recording channel 1-25
recording interval 2-105, 2-108
reflash 2-65
relay deactivated interval 2-65
release number v
repeat trigger 2-105
report template 2-125, 2-129, 2-196
rolling average 2-29, 2-73

S

samples, number of 2-29
Scale Lower 2-28, 2-47
Scale Upper 2-28, 2-47
scan interval 1-19, 2-98
self-signed certificate 2-217
sensor correction factor 2-44, 2-152
setup change procedure 2-11
single trigger 2-105
SMARTDAC+ GM 1-1
Span Lower 2-27, 2-46, 2-63, 2-72, 2-146
span upper 2-52
Span Upper 2-27, 2-46, 2-63, 2-72, 2-146
square root 2-27
standard type i
START/STOP key operation 2-70
status indication 2-7
style number v

T

text format 1-28
time deviation limit 2-184
transfer wait time 2-156
transfer wait time, shifting 3-55
trend interval 2-94, 2-108
trigger source operation 2-107
trusted certificate 2-199

U

uncorrected value 2-44, 2-152
unverified certificate 2-220
update interval of measured values 2-41
user authentication 2-158
user level 1-42
user privileges 1-43, 2-190
user registration 2-190

V

value modification from the monitor 2-97
verification of certificate 2-157, 2-158

W

watchdog timer 2-147
Web application, starting 2-4
Web application, closing 2-5

General Specifications

GS 04L55B01-01EN

Data Acquisition System GM

GM10 Data Acquisition Module
GM90MB Module Base
GM90PS Power Supply Module

SMARTDAC+TM

[Release 5]

OVERVIEW

The Data Acquisition System GM is a data logger that excels in versatility and expandability. The main unit includes on-board memory for data acquisition and also supports SD cards for external storage. The system consists of a Data Acquisition Module (GM10), Power Supply Module (GM90PS), and Module Base (GM90MB), which is used to mount a variety of modules.

SMARTDAC+ GM utilizes the same modules as the GX/GP series of SMARTDAC+.

- **High expandability and maintainability:** Employs YOKOGAWA's original block structure, making it easy to rearrange the combination of required modules. The structure also excels in maintainability because even after installation, every module can be removed separately.
- **Multichannel measurement:** Measures up to 420 analog input channels on the GM10-2 and up to 100 channels even on the GM10-1.
- **Flexible system configuration:** A wide variety of systems, such as multichannel measurement from 10 to 420 channels or data acquisition through communication, can be configured.
- **High environmental tolerance:** The guaranteed operating temperature range of -20°C to 60°C allows more freedom in where the system can be installed.
- **Mounting:** Not only can the system be installed on a desktop, it can also be mounted on DIN rails or a wall.
- **Less wiring through distribution:** Installation of sub units away from the main unit makes measurement possible without connecting sensor signal wires over a long distance.
- **Long-term recording and saving:** Large internal memory (500 MB on the GM10-1 and 1.2 GB on the GM10-2) allows long-term recording and saving.
- **Secure saving of recording data:** An SD card (SD/SDHC) up to 32 GB (1 GB included) can be used for the external storage medium. And the FTP client function can be used to provide data redundancy using a file server.
- **Rich I/O interface:** Seven types of I/O modules are available: analog input, analog output, digital input, digital output, digital I/O, pulse input and PID control. DCV (DC voltage), TC (thermocouple), RTD (resistance temperature detector), DI (contact or TTL level voltage), mA (DC current) can be assigned to each channel as input signals.
- **Web server function:** Various settings can be configured online from a Web browser, without using a dedicated software application. Moreover, measured data can be monitored in real time.
- **High withstand voltage performance:** Safe measurement up to withstand voltage of 600 V between input terminal and ground is possible by using a high withstand voltage analog input module.



- **High-speed measurement:** Measurement at the shortest interval of 1 ms is possible by using a high-speed analog input module.
- **Dual interval measurement:** Measurement can be performed by setting two different scan intervals.
- **Equipment/Quality Easy Predictive Detection Health monitor function:** This function judges quality based on a predictive detection model. You can check health scores that indicate degrees of normality and abnormality. Create predictive detection models with the Equipment/Quality Predictive Detection Tool (sold separately, in the cloud or offline) based on historical measurement data.

For more details, please see the Equipment/Quality Predictive Detection Tool General Specifications (GS 04L66B01-01EN).
- **Profile function:** This function alerts you to deviations from the profile trend (upper and lower range of measured values). You can also check deviations from a reference waveform on screen. Create profile trends with the Equipment/Quality Predictive Detection Tool (sold separately, in the cloud or offline) based on historical measurement data.

For more details, please see the Equipment/Quality Predictive Detection Tool General Specifications (GS 04L66B01-01EN).
- Note Judgments from equipment/quality easy predictive detection are for reference only. Performance, accuracy, and other properties are not guaranteed.
- **Simple settings:** The standard USB port makes it easy to connect with the PC.
- **Supports 21 CFR Part 11:** GM supports the USA FDA's Title 21 CFR Part 11 regulation by advanced security function (/ AS optional).

The contents of this general specifications correspond to the GM with release number 5 and style number 2.

Release number: firmware ID number (GM10)
Style number: hardware ID number (GM90PS)

• **PID control function:** PID control on up to 20 loops is possible by installing a PID control module.

• **Program control function (PG option):** Program control of up to 99 patterns is possible by using a PID control module and program control function. In addition, up to 32 time event and 32 PV events can be used.

* For details on the PID control module, PID control function, and program control function (/PG), see the GX90UTPID Control Module General Specifications (GS04L53B01-31EN).

• **Math function (MT option):** Various calculations are possible. The report function enables creation of hourly, daily, and monthly reports and other types of data.

Logic computation outputs results of computation as 0s or 1s to internal switches and DO channels.

• **Extensive network functions:** The standard Ethernet interface allows network features such as various e-mail notifications and FTP file transfer. In addition, Modbus/TCP, Modbus/RTU (/C3), EtherNet/IP (/E1), and CC-Link family SLMP communication (/E4) are supported.

• **PROFINET communication function:** PROFINET communication is available by connecting the GX90NW network module.

* For details on the network module and PROFINET communication, see the GX90NW network module general specifications (GS 04L53B51-01EN).

• **Universal Viewer software:** A free software application is available for displaying and printing waveforms of measured data on a PC.

• **Actual values underlying accurate measurements**

Input Type		Measuring accuracy ^{*1} (typical value ^{*2})
DCV	20 mV	± (0.01% of rdg + 5 μV)
	60 mV	± (0.01% of rdg + 5 μV)
	6V (1-5V)	± (0.01% of rdg + 2 mV)
TC ^{*3}	R, S	±1.1°C
	B	±1.5°C
	K (-200.0 to 1370.0°C)	± (0.01% of rdg + 0.2°C for 0.0 to 1370.0°C; ± (0.15% of rdg + 0.2°C) for -200.0 to 0.0°C
	K (-200.0 to 500.0°C)	±0.2°C for 0.0 to 500.0°C; ± (0.15% of rdg + 0.2°C) for -200.0 to 0.0°C
	J	± 0.2°C for 0.0 to 1100.0 °C; ± (0.10% of rdg + 0.2 °C) for -200.0 to 0.0 °C
	T	± 0.2°C for 0.0 to 400.0°C; ± (0.10% of rdg + 0.2 °C) for -200.0 to 0.0 °C
	N	± (0.01% of rdg + 0.2°C) for 0.0 to 1300.0 °C; ± (0.22% of rdg + 0.2°C) for -200.0 to 0.0 °C
RTD	Pt100 (-200.0 to 850.0°C)	± (0.02% of rdg + 0.2°C)
	Pt100 (high resolution) (-150.00 to 150.00°C)	± (0.02% of rdg + 0.16°C)

rdg: Reading value

- *1 These values have been calculated from the accuracy testing data at the time of shipment of the instrument from the factory. Applies to GX90XA-10-U2, A/D integration time 16.67 ms or more, General operating conditions: 23±2 °C, 55±10% RH, supply voltage 90–132, 180–264 V AC, power frequency within 50/60 Hz ±1%, warm-up of 30 minutes or more, no vibrations or other hindrances to performance.
- *2 For the measuring accuracy (guaranteed), see the module's general specifications (GS 04L53B01-01EN).
- *3 These values do not include the reference junction compensation accuracy.

■ CONFIGURATION

SMARTDAC+ GM handles a wide variety of applications through the combination of various modules.

The unit that includes GM10 (Data Acquisition Module) is called the *main unit*. A unit connected to the main unit via GX90EX (expansion module) is called a *sub unit*. Modules in a unit can be connected by installing a GM90MB (Module Base).

● Unit Types

Main Unit (Single Unit)

A unit consisting of a GM10 and a GM90PS. Up to 10 I/O modules* can be connected to a unit.



* Up to 8 when a GX90XA-T1 is connected

Main Unit (Multi Unit)

A unit consisting of a GM10, a GM90PS and a GX90EX. Up to six I/O modules can be connected to a unit. Up to six sub units can be connected via the GX90EX.



Sub Unit

A unit consisting of a GM90PS and a GX90EX. Up to six I/O modules can be connected to a unit. The main unit and sub units are connected directly using LAN cables. The maximum connection distance between two units is 100 m. It can also be used as an expandable I/O for the GX/GP paperless recorder.



* See "Restrictions and Cautions" on page 26.

• Module Types

Model	Description
GM10	Data Acquisition Module for SMARTDAC+ GM A module that acquires data from I/O modules and expansion modules. A main unit requires one module of this type.
GM90PS	Power Supply Module for SMARTDAC+ GM A module that supplies power to the modules connected in the unit. A unit requires one module of this type.
GX90EX*	Expansion Module A module that connects units to expand the system. A main unit or a sub unit requires one module of this type.
GX90NW	Network Module For communication using industrial network communication protocols. You can connect one network module to one main unit.
GM90MB	Module Base This is used to connect modules (excluding the GM90PS).

* The firmware version of GX90EX that can be used on the SMARTDAC+ GM must be R1.02.01 or later.

For the detailed specifications of the expansion module, see the following general specifications.

Material No.: GS 04L53B00-01EN

For the detailed specifications of the network module, see the following general specifications.

Material No.: GS 04L53B51-01EN

I/O Modules

Input/output modules may need to have their firmware updated.



Model	Description
GX90XA	Analog input module (number of inputs: 10) A module that can receive various analog signals.
Type Suffix code	
-U2	Universal, solid state relay scanner type (3-wire RTD b-terminal common) DC voltage, standard signal, thermocouple, resistance temperature detector (RTD), DI (voltage, contact), DC current (when an external shunt resistor is connected) Scan interval: 100/200/500 ms, 1/2/5 s Power consumption: 0.7 W
-C1	Current (mA), scanner type (isolation between channels) DC current (0-20 mA), DC current standard signal (4-20 mA) Scan interval: 100/200/500 ms, 1/2/5 s Power consumption: 0.7 W
-L1	Low withstand voltage DCV/TC/DI, scanner type (isolation between channels) DC voltage, standard signal, thermocouple, DI (voltage, contact), DC current (when an external shunt resistor is connected) Scan interval: 500 ms, 1/2/5 s Power consumption: 0.7 W

Continued on the following table

Model	Description
-T1	DCV/TC/DI, electromagnetic relay scanner type (isolation between channels) DC voltage, standard signal, thermocouple, DI (voltage, contact), DC current (when an external shunt resistor is connected) Scan interval: 1/2/5 s Power consumption: 0.9 W
-H0	High-speed universal, individual A/D (isolation between channels) (number of inputs: 4) DC voltage, standard signal, thermocouple, resistance temperature detector (RTD), DI (voltage, contact), DC current (when an external shunt resistor is connected) Scan interval: 1/2/5/10/20/50/100/200/500 ms, 1/2/5 s Power consumption: 2.0 W
-R1	4-wire RTD/resistance, solid state relay scanner type (number of inputs: 6) 4-wire RTD, 4-wire resistance Scan interval: 100/200/500 ms, 1/2/5 s Power consumption: 0.7 W
-V1	DCV/TC/DI, high withstand voltage scanner type (isolated between channels) DC voltage, standard signal, thermocouple, DI (voltage, contact), DC current (when an external shunt resistor is connected) Scan interval: 100/200/500 ms, 1/2/5 s Power consumption: 1.0 W
GX90XD	Digital input module (number of inputs: 16) A module that can receive open collector or voltage-free contact signals. Scan interval: 100/200/500 ms, 1/2/5 s Power consumption: 0.7 W
GX90YA	Analog output module (number of outputs: 4) A module that can transmit 4 to 20 mA DC or 0 to 20 mA DC signals. Output update interval: 100/200/500 ms, 1/2/5 s Power consumption: 3.0 W
GX90YD	Digital output module (number of outputs: 6) A module that can transmit relay contact (c contact) signals. Scan interval: 100/200/500 ms, 1/2/5 s Power consumption: 1.4 W
GX90WD	Digital I/O module (number of inputs: 8, number of outputs: 6) A module that can receive open collector or voltage-free contact signals and transmit relay contact (c contact) signals. Scan interval: 100/200/500 ms, 1/2/5 s Power consumption: 1.6 W
GX90XP	Pulse input module (number of inputs: 10) A module that can receive open collector, voltage-free contact, or 5 V logic signals. Scan interval: 100/200/500 ms, 1/2/5 s Power consumption: 0.9 W
GX90UT	PID control module (Number of inputs / outputs: universal input 2, current pulse or voltage pulse output 2, DI 8, DO 8) This module can perform PID control on up to 2 loops. It supports the following control modes: single loop, cascade, and loop control with PV switching. Control interval: 100/200 ms Power consumption: 2.8 W

For the detailed specifications of the I/O modules, see the following general specifications.

Material No.: GS 04L53B01-01EN

For the detailed specifications of the PID control module, see the following general specifications.

Material No.: GS 04L53B01-31EN

● System Configuration

SMARTDAC+ GM supports both standalone operation and data acquisition using a PC.

Restrictions on module connection

* See "Restrictions and Cautions" on page 26.

Single Unit System

A system configured with only a main unit.

Use as a stand-alone type



Use by connecting a PC

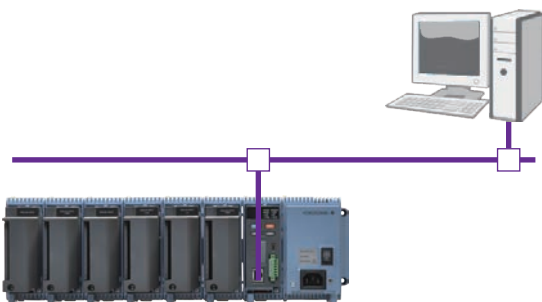

Multi Unit System

A system configured with a main unit connected to sub units*.

* The GX60 expandable I/O can also be used.

Note: The main unit and sub units are connected directly using LAN cables. Hubs and repeaters cannot be used.

- Up to six sub units can be connected to a main unit. Each unit can connect up to six modules.
- For analog input, up to 420 channels (GM10-2) and up to 100 channels (GM10-1) can be measured.

Use as a stand-alone type

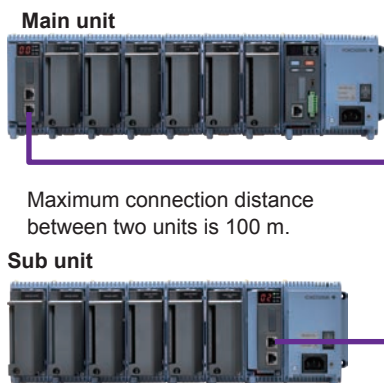

Use by connecting a PC

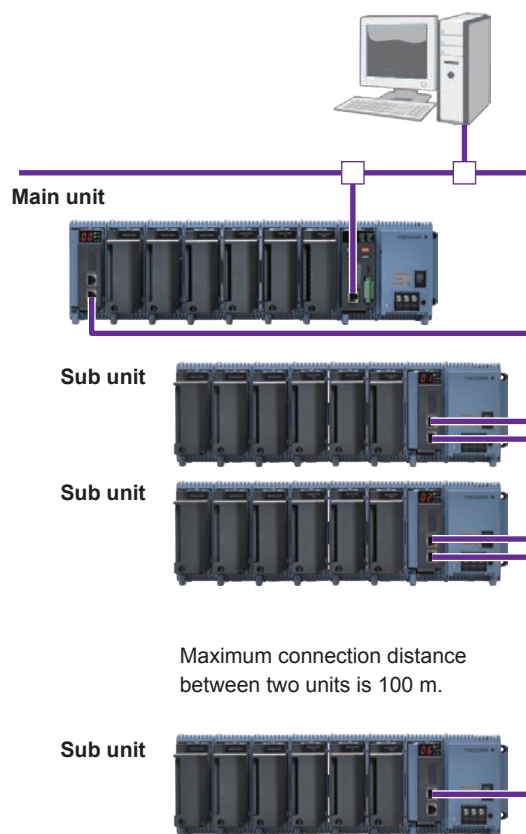

■ SMARTDAC+ GM COMMON SPECIFICATIONS

● Compliant Standards

- CSA: CSA C22.2 No. 61010-1, CSA-C22.2 No. 61010-2-030, CAN/CSA-C22.2 No. 61010-2-201⁴, Overvoltage Category II or I^{*1}, Pollution Degree 2^{*2}, Measurement Category^{*3}
 - UL: UL 61010-1, UL Std. No. 61010-2-030, UL 61010-2-201⁴ (CSA NRTL/C), Overvoltage Category II or I^{*1}, Pollution Degree 2^{*2}, Measurement Category^{*3}
 - CE, UKCA/EMC directives:
 - EN 61326-1 Class A Table 2 (For use in industrial locations) compliant
 - EN 61000-3-2 compliant
 - EN IEC 61000-3-2 compliant
 - EN 61000-3-3 compliant
 - CE, UKCA/Low voltage directive:
 - EN 61010-1, EN IEC 61010-2-030, EN IEC 61010-2-201⁴ compliant
 - Overvoltage Category II or I^{*1}, Pollution Degree 2^{*2}, Measurement Category^{*3}
 - CE, UKCA/EU RoHS directive: EN IEC 63000
 - WEEE directive: Compliant
 - Australia, New Zealand EMC standard (RCM):
 - EN 61326-1 Class A Table 2 (For use in industrial locations) compliant
 - KC mark: KS C9811, KS C9610-6-2 compliant
- /C8 option**
- CSA: CSA C22.2 No. 61010-1, CSA-C22.2 No. 61010-2-030, CAN/CSA-C22.2 No. 61010-2-201⁴, Overvoltage Category II or I^{*1}, Pollution Degree 2^{*2}, Measurement Category^{*3}
 - UL: UL 61010-1, UL Std. No. 61010-2-030, UL 61010-2-201⁴ (CSA NRTL/C), Overvoltage Category II or I^{*1}, Pollution Degree 2^{*2}, Measurement Category^{*3}
 - RE directive:
 - SAFETY**
 - EN 61010-1, EN IEC 61010-2-030, EN IEC 61010-2-201⁴ compliant,
 - Overvoltage Category II or I^{*1}, Pollution Degree 2^{*2}
 - Measurement Category^{*3}
 - EN 62311 compliant
 - EMC**
 - EN 301 489-1 compliant
 - EN 301 489-17 compliant
 - EN 61326-1 Class A Table 2 (For use in industrial locations) compliant
 - EN IEC 61000-3-2 compliant
 - EN 61000-3-3 compliant
 - SPECTRUM**
 - EN 300 328 compliant
 - CE, UKCA/EU RoHS directive: EN IEC 63000
 - WEEE directive: Compliant
 - Wireless module certification and the like:
 - FCC Approval, IC Approval, Japanese Radio Law
 - Korea Certification (Radio Wave Act),
 - China Certification (Radio Wave Act)

- Wireless communication standards of Australia and New Zealand (RCM): EN 61326-1 Class A Table 2 (For use in industrial locations) compliant AS/NZS 4268 compliant, AS/NZS 2772.2 compliant
- KC mark: KS C9811, KS C9610-6-2 compliant KS X 3124/3126 compliant

- *1 Overvoltage Category: Describes a number which defines a transient overvoltage condition. Implies the regulation for impulse withstand voltage. Applies to electrical equipment which is supplied from the fixed installation like a distribution board.
 II: Applied to power supply voltage code 1 (100-240 V AC)
 I: Applied to power supply voltage code 2 (12-28 V DC)
- *2 Pollution Degree 2: Describes the degree to which a solid, liquid, or gas which deteriorates dielectric strength or surface resistivity is adhering. "2" applies to normal indoor atmosphere. Normally, only non-conductive pollution occurs.
- *3 Measurement Category: Depends on the specification of each modules

Category	Measurement category	Description	Remarks
II	CAT II	Available in the testing and measuring circuits directly connected to a usage location (receptacle or the like) of a low-voltage main power supply facility.	Appliances, portable equipment, etc.
III	CAT III	Available in the testing and measuring circuits connected to a power distribution portion of a low-voltage main power supply facility.	Distribution board, circuit breaker, etc.
IV	CAT IV	Available in the testing and measuring circuits connected to a power source of a low-voltage main power supply facility.	Overhead wire, cable systems, etc.

- *4 This product is designed as open equipment under the relevant standard, install it as follows:
- Install the GM unit / GX60 in a panel with a door.
 - The instrumentation panel or panel used for support must comply with CSA/UL/EN/IEC 61010-2-201 or must be at least IP1X (degrees of protection) and at least IK09.

- The /WH option does not support standards other than KC mark.

• Normal Operating Conditions

- Rated supply voltage:
100 to 240 V AC (AC power supply) or
12 to 28 V DC (DC power supply)
- Allowable supply voltage:
90 to 264 V AC (AC power supply) or
10 to 32 V DC (DC power supply)
- Power frequency (AC power supply):
50 Hz $\pm 2\%$, 60 Hz $\pm 2\%$
- Power consumption:

Supply voltage	Normal operation*	Maximum
100 V AC	25 VA	45 VA
240 V AC	35 VA	60 VA
12 V DC	15 VA	24 VA
28 V DC		

* When 10 analog input modules are connected

- Ambient temperature: -20 to 60 °C
 -20 to 50 °C in the following cases
 - When a GX90YD is used
 - When a GX90WD is used
 - When a GX90XA-T1 (electromagnetic relay type) is used
 - When a GX90YA is used
 - When a GX90UT is used
 - On a GM10 with the /C8 option
- Ambient humidity: 20 to 85 %RH
(no condensation)
- Magnetic field: 400 A/m or less (DC and 50/60 Hz)
- Vibration: $5 \leq f < 8.4$ Hz amplitude 3.5 mm (peak)
 $8.4 \leq f \leq 160$ Hz acceleration 9.8 m/s² or less
- Shock: Power supply ON, 98 m/s² or less, 11 ms
(excluding GX90YD and GX90WD)
Power supply OFF, 500 m/s² or less,
approx. 10 ms
6 directions ($\pm X$, $\pm Y$, $\pm Z$), 3 times in each direction
- Mounting position: Left and right horizontal, front and back horizontal
- Altitude: 2000 m or less
- Installation location: Indoors
- Warm-up time: At least 30 minutes after power on

• Transport and Storage Conditions

- Ambient temperature: -25 to 70 °C
- Ambient humidity: 5 to 95 %RH (no condensation)
- Vibration: 10 to 60 Hz, 4.9 m/s² maximum
- Shock: 392 m/s² maximum (in packaged condition)

• Construction

Mounting: Wall mount, DIN rail (panel storage, rack), desktop

Note: No stacking

Material: Polycarbonate

■ GM10 DATA ACQUISITION MODULE SPECIFICATIONS

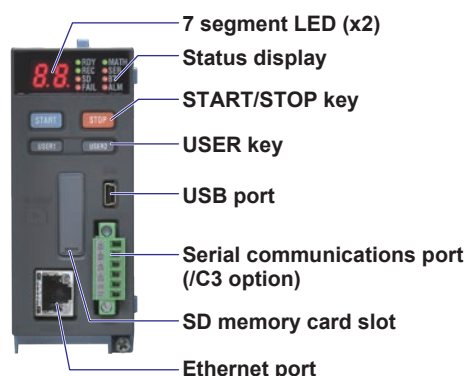

7 segment LED: Displays the operation mode, system No., self-check operation, key lock, operation error, process running, and module installation information.

Status display:

Item	LED color	Description
RDY	Green	System normal indication
REC	Green	Recording status
SD	Orange	SD card access status
FAIL	Red	System error indication
MATH	Green	Computation status
SER	Orange	Serial communication status
BT	Orange	Bluetooth communication status
ALM	Red	Alarm status

START key: Starts recording and computation

STOP key: Stops recording and computation, clears errors

USER keys (USER1/USER2):

Executes specified actions (event action function)

• Functional Specifications

Measuring Function

Number of connectable modules and number of I/O channels:

GM10-1

Modules	I/O channels
Up to 10	Up to 100

GM10-2

Modules	I/O channels
Up to 42	Up to 500 (up to 420 if AI only)

- Measurement mode:

Normal, High speed, Dual interval

Normal: A mode in which the shortest measurement interval is 100 ms

Number of scan groups: 1

File type: Event data, display data

Data format: Binary, text

Scan interval: Fastest 100 ms

Compatible modules: All modules

High speed: A mode in which the shortest measurement interval is 1 ms

Number of scan groups: 1

File type: Event data only

Data format: Binary only

Scan interval: Fastest 1 ms

Compatible modules:*

High-speed AI (GX90XA-4-H0)

- * A single DI (GX90XD) or DIO (GX90WD) can be connected for remote input. Measurement and recording are not possible.

Dual interval: A mode in which measurement is possible by setting different scan intervals on the two scan groups.

Number of scan groups: 2

File type: Event data only

Data format: Binary only

Scan interval:

Model	Scan group 1	Scan group 2
GM10-1	Fastest 5 ms	Fastest 100 ms
GM10-2	Fastest 1 ms	Fastest 100 ms

Master scan interval:

Scan group 1 or scan group 2

Master scan interval is used for the following:

Math function's scan interval, communication channel function's scan interval, manual sampling function's detection timing, logic math interval, instantaneous values included in e-mails

Compatible modules: Modules other than the PID control module

- Scan interval: 1 ms / 2 ms / 5 ms / 10 ms / 20 ms / 50 ms / 100 ms / 200 ms / 500 ms / 1 s / 2 s / 5 s

Note: Some intervals will be unavailable depending on the system configuration and modules.

- Scan intervals shorter than 1 s cannot be specified on electromagnetic relay type (type suffix code -T1) analog input modules.
- Scan intervals shorter than 500 ms cannot be specified on low withstand voltage relay type (type suffix code -L1) analog input modules.
- Scan interval shorter than 100 ms can only be specified when the measurement mode is set to High speed or Dual interval.

Module connection limitations:

See "Restrictions and Cautions" on page 27.

Channel Specifications

Operations such as measurement, computation, and recording are performed on channels.

- Channel name: A channel name is expressed with a 4-digit number. Channel names are specific to the system, so they cannot be changed. By setting tags or tag numbers to the channels, you can use any names you like.

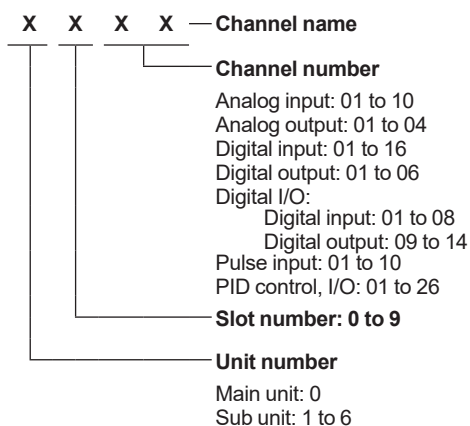
**Display Function**

Real-time data monitoring is possible using a Web browser.

- Number of groups: GM10-1: 50, GM10-2: 60
- Number of channels that can be assigned to each group: 20
- Display types: Trend, digital, bar graph, horizontal bar graph, overview, alarm summary, message summary, DO channel status, internal switch status, Modbus master status, Modbus client status, WT client status, SLMP client status, memory data list, report data list, manual sampled data list, various error logs, network information, system information

Display update interval: Minimum 1 second

Data Saving Function

Data is recorded to internal memory and external storage medium. When the system recovers from a power failure, the operation that was being performed before the power failure is resumed.

- Internal memory: Temporarily saves various types of data.

Medium: Flash memory

Size: GM10-1: 500 MB

GM10-2: 1.2 GB

- External storage medium:

Medium: SD card (SD/SDHC)

Size: 1 to 32 GB (1 GB included)

Format: FAT32 or FAT16

Data saving to the external storage medium:

Select whether to save automatically or when a medium is inserted for event data, display data, manual sampled data, and report data.

Auto save: Automatically saves to the internal memory when a data files is created.

Save when a medium is inserted:

Saves unsaved data files when an external storage medium is inserted.

- Data type:

Data type	Saved content
Display data	Maximum and minimum values per recording interval
Event data	Instantaneous values at recording intervals
Alarm summary data	Summary of warnings
Manual sampled data	Instantaneous values at a user specified time
Setup data	GM10 and I/O module settings
Report data (/MT option)	Report at each scheduled time of report
Health monitor log data	Health score and good/bad judgment (OK / NG)

- Event data:

Target: Measurement (I/O module)/math (/MT)/ communication (/MC) channels, alarm summary, message summary

Recording interval: 1 ms / 2 ms / 5 ms / 10 ms / 20 ms / 50 ms / 100 ms / 200 ms / 500 ms / 1 s / 2 s / 5 s / 10 s / 15 s / 20 s / 30 s / 1 min / 2 min / 5 min / 10 min / 15 min / 20 min / 30 min selectable

Note: Some intervals will be unavailable depending on the scan interval and number of channels.

Number of channels: Determined by the scan interval and recording data type

Measurement mode: Normal

GM10-1

Recording interval	Number of channels
100 ms	100
200 ms	200
500 ms or longer	500

GM10-2

Recording interval	Number of channels *1	
	Event	Display + Event
100 ms	500	100
200 ms	500	200
500 ms	1000	500
1 s or longer	1000	1000

Measurement mode: High speed

Recording interval	Number of channels *1	
	GM10-1	GM10-2
1 ms	2	10
2 ms	4	20
5 ms	10	50
10 ms	20	100
20 ms	40	150
50 ms	100	150
100 ms	100	200
200 ms	200	500
500 ms	500	1000
1 s or longer	500	1000

Measurement mode: Dual interval

Recording interval	Number of channels *1*2	
	GM10-1	GM10-2
1 ms	---	5
2 ms	---	10
5 ms	5	25
10 ms	10	40
20 ms	20	50
50 ms	50	50
100 ms	100	100
200 ms	100	200
500 ms	250	600
1 s or longer	250	600

*1 Total number including I/O channels, math channels, and communication channels

*2 Number of channels that can be recorded is the same for scan group 1 and scan group 2.

Data size (binary):

Analog input data: 6 bytes/ch.

Analog output data: 6 bytes/ch.

Digital I/O data: 2 bytes/ch.

Math channel data: 6 bytes/ch.

Communication channel data: 6 bytes/ch.

File size (binary): Up to 18 MB

Number of files (including display data) (internal memory)

GM10-1: Up to 500

GM10-2: Up to 1000

Internal memory operation: FIFO (First In First Out)

Data format: Binary or text*

* Selectable when saving to the external storage medium

Mode:

Free: Records data at all times

Trigger: Starts recording data when a certain event occurs and records for the specified interval

Repetition trigger: Repeat Trigger mode

Event data file sample time (estimated)

GM10-1 (when recording interval is 1 s)

I/O channels	Total sample time
30	Approx. 29 days
100	Approx. 9 days

GM10-2 (when recording interval is 1 s)

I/O channels	Total sample time
30	Approx. 71 days
100	Approx. 23 days
300	Approx. 7 days

• Display data:

Target: Measurement (I/O module)/math (/MT)/ communication (/MC) channels, alarm summary, message summary

Trend interval (/div) (recording interval): 5 s / 10 s / 15 s / 20 s / 30 s / 1 min / 2 min / 5 min / 10 min / 15 min / 20 min / 30 min selectable

Note: Some intervals will be unavailable depending on the scan interval and number of channels.

Number of channels: Determined by the trend interval and recording data type

GM10-1

Trend interval setting (/div)	Recording interval	Number of channels
5 s	100 ms	100
10 s	200 ms	200
15 s or longer	500 ms or more	500

GM10-2

Trend interval setting (/div)	Recording interval	Number of channels	
		Category	Display + Event
5 s	100 ms	200	100
10 s	200 ms	500	200
15 s	500 ms	1000	500
30 s or longer	1 s or longer	1000	1000

Data size (binary):

Analog input data: 12 bytes/ch.

Analog output data: 12 bytes/ch.

Digital I/O data: 4 bytes/ch.

Math channel data: 12 bytes/ch.

Communication channel data: 12 bytes/ch.

File size (binary): Up to 18 MB

Number of files (including event data) (internal memory)

GM10-1: Up to 500

GM10-2: Up to 1000

Internal memory operation: FIFO(First In First Out)

Data format: Binary or text *

* Selectable when saving to the external storage medium

Display data file sample time (estimated)

GM10-1 (when recording interval is 1 min)

I/O channels	Total sample time
30	Approx. 914 days (2.5 years)
100	Approx. 239 days (9 months)

GM10-2 (when recording interval is 1 min)

I/O channels	Total sample time
30	Approx. 2184 days (5.9 years)
100	Approx. 702 days (1.9 years)
300	Approx. 239 days (7 months)

• Alarm summary:

Saved item: Alarm of each data item

Maximum number of items saved to internal memory: 5000

- Internal memory operation: FIFO(First In First Out)
Maximum number of items displayed on Web screen: Latest 1000
- Save operation: Saves alarm information to internal memory when an alarm occurrence or release is detected
- * Alarm information is saved to the corresponding event or display data file.
- Saved content: Target channel name (tag name), time of occurrence or release, warning type, etc.
- Save operation methods: Web browser, communication command
- Message summary:

Description: Saves a summary of written messages

Saved item: Message string

Maximum number of items saved to internal memory: 1000

Internal memory operation: FIFO (First In First Out)

Maximum number of items displayed on Web screen: Latest 450

Save operation: Saves message information to internal memory when message writing operation is performed.

 - * Message information is saved to the corresponding display or event data file.

Saved content: Message name, writing interval, user name, write group
 - Manual sampled data:

Saved item: Measurement (I/O module)/math (/MT)/communication (/MC) channels

Number of saved channels:
GM10-1: Up to 50, GM10-2: Up to 100

Save operation methods: Web browser, communication command, event action

Maximum number of events saved to internal memory: 400

Internal memory operation: FIFO (First In First Out)

Auto saving to an external storage medium: Every time manual sampling is executed

Data format: Text format
 - Setup data

Saved item: GM10 and I/O module settings (including setup data of modules connected via GX90EX)

Saved events: Operation from a Web browser, communication command, event action, setting changes (when the advanced security function (/AS) is on)

Data format: Text format
Binary format when the advanced security function (/AS) is on
 - Report data (/MT option):

Saved item: Measurement (I/O module)/math/communication channels

Select from average, maximum, minimum, sum, and instantaneous values

Type: Hourly + daily, daily + weekly, daily + monthly
User specified time (batch, day custom)

Saved events: Timeout time of each report type

Maximum number of items saved to internal memory: 800

Internal memory operation: FIFO (First In First Out)

Auto saving to an external storage medium: Save every time of the event

Data format: Test format
 - Health monitor log data

Maximum number of items saved to internal memory: 300

Internal memory operation: FIFO (First In First Out)

Auto saving to an external storage medium: When 100 logs are accumulated

Data format: Test format
 - User data

Saved item: Excel report template (/MT), PDF/print report template, SSL communication certificate (server certificate, trusted certificate), electronic signature certificate (/MT), profile trend, load predictive detection model

Recorded events: Operation from a Web browser, communication command
- ### Message Write Function
- Messages can be written to event data and display data.
- Message type:

Preset message: Writes preset text

Free message: Writes text that you enter

Auto message: Writes fixed text when power recovers after a power failure occurs during recording and writes the result when calculating the health score.
 - Preset message, free message:

Number of displayable characters: Up to 32

Displayable character types: Alphanumeric, Japanese, and Chinese characters

Number of messages: Preset message: 100
Free message: 10

Free messages that you enter are also saved in setup files.

Write method: Operation from a Web browser, communication command, event action

Write destination: Specified event data or display data group or all groups
 - Auto message

Displayed text: "Power-fail" + the time of failure occurrence

Example: Power-fail 2014/01/06 09:49:21

Results when calculating health score
Example: OK +1.000 ModelFileName.GDG

Write method: Writes a message when power recovers after a power failure occurs during recording and writes the result when calculating the health score. Whether or not to write is selectable.

Write destination: All display data or event data group
- ### Alarm Function
- Number of alarms: Up to four alarms (levels) for each measurement channel
 - Alarm type: High limit, low limit, difference high limit, difference low limit, high limit on rate-of-change, low limit on rate-of-change, delay high limit, delay low limit, profile high limit, and profile low limit
 - Alarm delay time: 1 s to 24 hours (for each channel)
 - Rate-of-change calculation interval of rate-of-change alarms: 1 to 32 times the scan interval (common to all channels)
 - Hysteresis: 0.0 to 5.0% of the span (for each alarm (level))

- Alarm output:
DO output:
DO operation: Energize/de-energize, hold/nonhold, AND/OR, reflash
- Internal switch output:
Number of internal switches: 100
Internal switch operation: AND/OR operation selectable
- Status LED display operation: Select whether or not to hold the indication until an alarm acknowledge operation is performed
- Alarm no logging function: Possible to output only to the DO or internal switch when an alarm occurs (warning display and recording to the alarm summary are not performed)
- Alarm information: Displays a log of alarm occurrences on the alarm summary
- Reflash: The duration for which the reflash relays are deactivated can be set to 500 ms, 1 s, or 2 s.
- Individual alarm ACK function: Alarm display and relay output can be canceled on individual alarms.

Event Action Function

- Description: Execute a specified operation when a given event occurs.
- Number of settings: 50
Events: Remote control input, etc.
Timer: Number of timers: 12
Match time timer: Number of timers: 12
Action: Specify memory start/stop, alarm ACK, etc.

Control Event Action Function

See the GX90UT PID Control Module General Specifications (GS04L53B01-31EN).

Equipment/Quality Easy Predictive Detection

Health Monitor Function

- Target channel: Input/output channel, math channel, communication channel
- Number of target channels: 20
- Health monitor: Judgment (OK / NG (Not Good)), health score and predictive detection model name
- Predictive detection section:
Start/Stop: Screen operation, Sync with recording, Threshold, Event action, Modbus, Communication command, Repeat
- Operating conditions:
Multi-batch function (/BT): Off
Measurement mode: Normal

Profile Function

- Target channel: Input channel, math channel, communication channel
- Number of target channels: 20
- Predictive detection section:
Start/Stop: Screen operation, Sync with recording, Threshold, Event action, Modbus, Communication command, Repeat
- Hold: Screen operation, Event action, Modbus, Communication command
- Operating conditions:
Multi-batch function (/BT): Off
Measurement mode: Normal
Scan interval: 500 ms or more
Note: Communication channel (/MC) required if using the profile function.

Security Function

- Key lock function: All GM10 key operations
- Login function: Only registered users can operate the GM (Ethernet /serial (/C3) /USB/ Bluetooth (/ C8) operation) (including Web browsers)
System administrators and users: Up to 50
Number of Authority of user: 10 levels

Manual Sampling Function

- Description: Measured value at a user specified time
- Target: Measurement (I/O module)/math (/MT)/communication (/MC) channels
- Number of recording channels:
GM10-1: Up to 50
GM10-2: Up to 100
- Maximum number of data values that the internal memory can store: 400
- Data format: Text

Report Function (/MT option)

- Description: Report at each scheduled time of report
- Target: Measurement (I/O module)/math/communication channels
- Number of report channels: 60
- Maximum number of data values that the internal memory can store: 800
- Data format: Text

Setup Function

- Description: GM10 and I/O module setup
- Setup method: Web browser, communication commands, Hardware Configurator
- Output/read destination (for saving/loading): External storage medium

Clock Function

- Clock: With a calendar function
Accuracy: ± 5 ppm
Excludes the delay (of 1 second, maximum) caused when the power is turned on.
- Time difference between units: ± 2 ms max. (time difference between a sub unit and main unit)
- Time setting: Using Web operation, communication commands, event action, or SNTP client function
- Time adjustment method:
Limit in which the time is gradually adjusted:
Select from the available settings between 5 s and 15 s.
Whether to change an out-of-limit operation immediately or report it as an error can be selected.
While memory sampling:
Corrects the time by 1 ms for each second.
While memory is stopped:
Immediately change the time.
- Time zone: Sets the time difference from GMT
- Date format: Select "YYYY/MM/DD", "MM/DD/YYYY", "DD/MM/YYYY" or "DD.MM.YYYY".
MM expression can be selected from the numeric character or ellipsis. Ex. January: 01 or Jan
The delimiter can be selected from "/", ".", "-".

Ethernet Communication Function

- Electrical specifications: Conforms to IEEE 802.3
- Connection: Ethernet (10BASE-T/100BASE-TX)
- Max. segment length: 100 m
- Max. connecting configuration: Cascade Max. 4 level (10BASE-T), Max. 2 level (100BASE-TX)
- Connector: RJ-45
- Protocols: TCP, UDP, IP, ICMP, ARP, DHCP, HTTP, FTP, SMTP, SNMP, Modbus, dedicated protocols, and DARWIN compatible communication
- E-mail client: Automatically sends e-mail at specified times
E-mail is sent by events as below.
 - Alarm occurring/alarm cancelling
 - Recover from power failure
 - Report data generating
 - Storage medium error, FTP client function error
 - Specified time period
 - When the health score is below the early notification threshold (if a threshold is set) and when the health score is less than 0
- Supported authentication methods: POP before SMTP, SMTP authentication (Login, Plain, CRAM-MD5)
- FTP client: Automatically transfers data files to the FTP server
Applicable files: Event data, display data, report data, etc.
- FTP server: Transfers files, delete files, manipulate directories, and outputs file lists
Max. number of the simultaneous connections: 4
- Web server: GM10 real-time monitoring and setting changes/operations can be performed from a Web browser.
Max. number of the simultaneous connections: 4
- SNMP client: Inquires the time to the SNMP server and sets the GM10
- SNMP server: Outputs the GM10 time.
Time resolution: 10 ms
- DHCP client: Automatically obtains the network address settings from the DHCP server
- Modbus client: Reads data from another device and writes to the registers (Required /MC option)
Number of connectable servers:
GM10-1: Up to 16
GM10-2: Up to 32
- Modbus server: Loads measurement and math channel data
Loads and writes communication channel data
Some control commands such as memory start
Filtering to accept connections only from specific IP addresses available
Max. number of the simultaneous connections: 4 (or 2 when using the network module (protocol: PROFINET))
- Setting/Measurement server:
Operate and set the GM10 and output data using a dedicated protocol.
Max. number of the simultaneous connections: 4
- DARWIN compatible communication server:

Supports some DARWIN commands
Communication with the GM10 is possible using DARWIN communication commands.

Output-related commands: Outputs measurement channel data, math channel data, relay status, decimal place of measurement channels, decimal place of math channels, system configuration information

Setup-related commands: Range, Scale unit, Alarm, Time, Moving average

Operation-related commands: Reset alarm, Reset timer, Start MATH calculation, Rebuild system, Initialize, Input communication, Output communication DO, Write message

Note: To control the GM using the DARWIN compatible communication function, you must configure the GM (module type, channel numbers (unit numbers and slot numbers)) to match DARWIN.

Batch Function

- Function: Data management using batch names.
Enter text fields and batch comments in the data file.
- Batch name: Added to the file name of the event data and display data.
Structure: Batch number (up to 32 characters) + lot number (up to 8 digits)
Use/not use selectable for lot number, on/off selectable for auto increment function.
- Text field: Adds text to the event data and display data. There are 24 available text fields.
Title: Up to 20 characters
Text: Up to 30 characters per field
- Batch comment: Adds text to the event data and display data. 3 comments (max. 50 characters/comments) are available.

USB Communication Function

- Compliant standard: USB2.0
- Interface:
Connector: mini B type
Number of ports: 1
Power supply: Self powered
- Implemented protocol: Dedicated protocol
Operate and set the GM10 and output data using a dedicated protocol.
- Communication conditions:
Baud rate: 115200 bps, Parity: None, Data length: 8 bit, Stop bit: 1 bit, Handshake: Off

FAIL Output Function

- Function: Relay output from a specified channel of the GX90YD or GX90WD when a CPU error occurs
- Output format: Relay contact
- FAIL output: Relay contact output when any of the various errors is detected
Normally energized; de-energized when a system error occurs

Printer Output Function

- Printers supporting the HP PCL5c language and can print through port 9100 on a LAN connection
Supports printing using the report template function (/MT).

SSL Communication Function

Communication that sends and receives information encrypted by the SSL (Secure Socket Layer) protocol is possible.

- Server function:
 - Supported servers: HTTP server and FTP server
 - Private key: Can be created on the GM10
 - Server certificate: Server certificates created by users can be saved in the internal memory.
 - Self-signed certificates can be created on the GM10.
- Client function:
 - Supported clients: FTP client and SMTP client
 - Trusted certificate: Trusted certificates (up to 80 KB total) can be saved in the internal memory.

Electronic Signature Function

Electronic signatures can be added to report files created in PDF format using the PDF form creation function. An electronic signature is provided each time a report file is created.

- Electronic signature certificate:
 - Electronic signature certificates created by certificate issuing organizations can be saved in the internal memory.

Loop Control Function (when a PID control module is installed)

See the GX90UT PID Control Module General Specifications (GS04L53B01-31EN).

Other Function

- Firmware update function:
 - The firmware of the GM10 and connected modules can be updated from the GM10.
- A/D calibration function:
 - The A/D calibration of connected modules can be operated from the GM10.

Web Server Function

Real-time data monitoring and setting changes/operations can be performed from a Web browser.

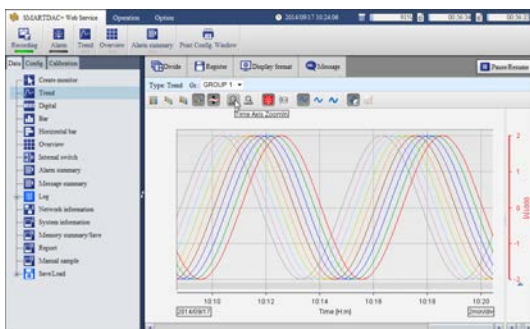
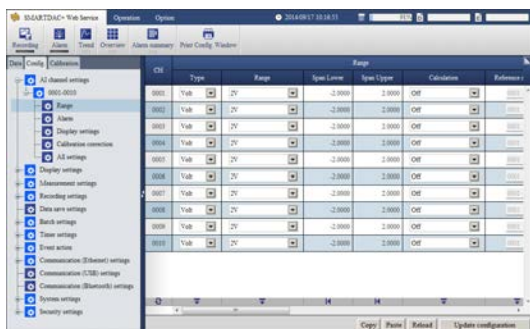

PC System Requirements

Hardware

Item		Specifications
CPU	Windows 10	Intel Core2 Duo E6300 or faster x64 or x86 processor
	Windows 11	Intel Core i5 or faster, and 8th generation or later Intel processor.
Internal memory	Windows 10	2 GB or more
	Windows 11	8 GB or more
Hard disk	Windows 10	100 MB or more free space, NTFS recommended
	Windows 11	64 GB or more free space, NTFS recommended
Printer		Printer compatible with the OS
Mouse		Mouse compatible with the OS
Display		Display compatible with the OS with 1024×768 dots or better, high color or better
Communication port		Ethernet port compatible with the OS and TCP/IP protocol

OS

Item	Specifications
Windows 10	Home (32-bit and 64-bit editions)
	Pro (32-bit and 64-bit editions)
	Enterprise LTSC (32-bit and 64-bit editions)
	Enterprise LTSC (32-bit and 64-bit editions)
Windows 11	Home (64-bit edition)
	Pro (64-bit edition)
	Enterprise (64-bit edition)

Compatible Browsers

Microsoft Edge, Google Chrome

• Specifications of Options

Advanced Security Function (IAS)

Security functions, electronic recording and electronic signature functions, and data integrity functions complying with FDA 21 CFR Part11 will be added.

- Enabling/disabling the advanced security function:
 - You can enable or disable the advanced security function.

* The set values and data stored in the internal memory are initialized each time the function is enabled or disabled.

- Login function: Using the login function described below, you can enter security settings on the instrument
 - User name, password, and user ID (depending on the use/not use setting)

User level:

Administrator: No restrictions (all operations)

Second administrator: Admin property and user property settings can be used to restrict executable operations and signatures.

User: Operations that can be executed can be set using the authority of user settings.

Monitor user: Only monitoring and changing passwords are possible.

Number of users: Up to 100 including administrators, second administrators, users, and monitor users (up to 200 on the GM10-2)

Admin property: Restrictions can be placed on GM operations that second administrators are allowed to perform.

- Authority of user: Users can be restricted from performing GM operations.
- Number of authority of user: 10
- Password expiration period: Off, 1 month, 3 months, 6 months or 1 year (no expiration period for monitor users)
- Password policy function: The minimum number of characters, the types of characters that must be included, and the number of previous passwords can be set.
- Advance notice of expiry date: A message encouraging the user to change the password is displayed when the user logs in during the specified notification period (Off, 5 days before, 10 days before).
- Signature restriction: Users can be restricted from signing measurement data files.
- Number of signature restrictions: 8
- Password control function: Logins are verified by a Kerberos v5 authentication server* (only user name and password)
- Encryption method:
 - AES128-CTS-HMAC-SHA1-96
 - AES256-CTS-HMAC-SHA1-96
 - ARCFOUR-HMAC-MD5
- Pre-Auth function: use
- Cross-realm function: use

* The function has confirmed compatibility with Windows Server 2012 / Windows Server 2016 / Windows Server 2019 / Windows Server 2022 Active Directory.

- Audit trail function: The history of operations from when the recording was stopped the previous time to when the recording was stopped this time is recorded as event log and saved in measurement data files along with the settings.
Comments that are entered when settings are changed or when an alarm is acknowledged are recorded in the event log. This allows you to check the comments and details of the setting changes.
- Data anti-tamper function: Settings and measured data are saved as encrypted binary files.
- Data type: Only for display or event
Trigger mode is not possible with event data.
- Signature function*: Includes approval information to measurement data files
Information that can be included: User name, pass/fail, comment
Number of signatures: Up to 3 per file
Signature privileges: Can be set for each user
 - * Universal Viewer is used to sign measurement data.
 - Signing measurement data files is not possible from the GM10.
- Measurement mode limitations: Measurement modes High speed and Dual interval cannot be used.
- Module limitations: PID control modules cannot be used.

Serial Communication Interface (/C3)

- Connection: EIA RS-422/485
- Protocol: Dedicated protocol, Modbus/RTU, or DARWIN compatible communication

- Setting/measurement server function: Operation, setting or output of measurement data are available by dedicated protocol.
- Synchronization: Start-stop synchronization
- Transmission mode (RS-422/485):
 - RS-422: Four-wire half-duplex multi-drop connection (1:n (n = 1 to 31))
 - RS-485: Two-wire half-duplex multi-drop connection (1:n (n = 1 to 31))
- Baud rate: 1200, 2400, 4800, 9600, 19200, 38400, 57600, or 115200 bps
- Data length: 7 or 8 bits
- Start bit: 1 bit
- Stop bit: 1 bit or 2 bit
- Parity: ODD, EVEN, or NONE
- Communication distance: 1200 m (57600 bps or less), 600 m (115200 bps)
- Modbus/RTU communication: Reading or writing of measurement data on other instruments is available by Modbus protocol.
Communication channel function (/MC option) is needed to read measurement data from other instruments.
- Modbus operation modes: Master or slave

Bluetooth Communication Function (/C8)*

- Data monitoring, setting, and operation is possible on a tablet, such as a Bluetooth compatible PC or smartphone, through Bluetooth communication.
- Compliant standard: Bluetooth Ver 2.1+EDR
- Supported profile: SPP (Serial Port Profile)
- Carrier frequency band: 2402 to 2480 MHz
- Channel spacing: 1 MHz
- Number of channels: 79
- Communication distance: Approx. 10 m (depends on the operating environment) (Class2)
- Protocol: Dedicated protocol
Operate and set the GM10 and output data using a dedicated protocol.
- Pairing: Maximum number of connections 8 (multi pairing)
Overwritten through FIFO when 8 units are exceeded
Displays the 6-digit SSP (Secure Simple Pairing) authentication code and checks for a match (numeric comparison)
- Password request function: Requests connected terminals for passwords
 - * Regions in which Bluetooth can be used are restricted by the Radio Waves Act of each country. For details, contact the appropriate authority.

Mathematical Functions with Report Function (/MT)

Mathematical Function:

- Number of math channels: GM10-1: 100, GM10-2: 200
Note: There is a limitation on the number of math channels when the scan interval is shorter than 100 ms.
See "Restrictions and Cautions" on page 27.
- Scan interval

Measurement mode	Scan interval
Normal	Scan interval
High speed	Scan interval
Dual interval	Master scan interval

- Expression: Up to 120 characters

- Operations:
 - General arithmetic operations:
 - Four arithmetic operations (+, -, *, /), square root, absolute, common logarithm, natural logarithm, exponential, and power
 - Relational operations: <, ≤, >, ≥, =, and ≠
 - Logic operations: AND, OR, NOT, and XOR
 - Statistical operations:
 - TLOG (maximum, minimum, average, sum, P-P values of time series data), CLOG (maximum, minimum, average, sum, P-P values of a specified channel)
 - Special operations: PRE, HOLD, RESET, CARRY
 - Conditional operation: [a?b:c]
 - Bit operation: BIT
 - Integer extracting operation: INT
 - Remainder extracting operation: MOD
 - Trigonometric functions: SIN, COS
 - CP calculation: CP.O2, CP.CO2
 - Special CLOG.AVE calculation: CLOG.PAVE
- Computation accuracy:
 - Double-precision floating point
- Data that can be used
 - Channel data:
 - Measurement channels: 0001 to 6516
 - Math channels: A001 to A100 (GM10-1)
A001 to A200 (GM10-2)
 - Communication channels:
 - C001 to C300 (GM10-1)
 - C001 to C500 (GM10-2)
 - Communication channel raw data:
 - RC001 to RC300 (GM10-1)
 - RC001 to RC500 (GM10-2)
 - Constants: K001 to K100
 - Variable constant: W001 to W100
 - Internal switches: S001 to S100
 - Flags: F01 to F20
 - Recording state: REC01
 - Integer data: Z000 to Z999

Logic math function:

- A function that outputs calculated results as 0 or 1 to DOs or internal switches
- Number of logic maths: 50
- Math interval: Fastest 100 ms
- Expression: Up to 120 characters
- Math type: Basic arithmetic, relational, logical, conditional, bit
- Data that can be used: All channel data
Logic math: LM001 to LM050
- Output destination: Internal switches, DO channels (only when set to Manual)
- Setting change: Cannot be changed during recording

Report function:

- Report at each scheduled time of report.
- Number of report channels: 60
- Target: Measurement (input/output module)/math/communication channels
- Note: There is a limitation on the number of report channels when the scan interval is shorter than 100 ms. See "Restrictions and Cautions" on page 27.
- Scan interval

Measurement mode	Scan interval
Normal	Scan interval
High speed	Scan interval
Dual interval	Scan interval of each group

- Report types: Hourly + daily, daily + weekly, daily + monthly, batch, day custom
- Computation types: Average, maximum, minimum, sum, instantaneous value
Unit of sum: OFF, /s, /min, /hour, /day
- Report templates: Office Open XML spreadsheet files (which can be displayed with Microsoft Office Excel) or PDF files can be output or printed out with any LAN-connected printer supporting the HP PCL5c language and the port 9100.

Communication Channel Function (/MC)

Data of external devices, such as PLC and PC, can be displayed and recorded.

- Number of communication channels:
 - GM10-1: 300 (C001 to C300)
 - GM10-2: 500 (C001 to C500)
- Note: There is a limitation on the number of communication channels when the scan interval is shorter than 100 ms. See "Restrictions and Cautions" on page 27. The minimum communication channel update interval is 100 ms.

- Scan interval

Measurement mode	Scan interval
Normal	Scan interval
High speed	Scan interval
Dual interval	Master scan interval

- Calibration correction:
 - Mode: Linearizer approximation, linearizer bias, correction coefficient *
 - Number of set points: 2 to 12
 - * Only when the /AH option is installed

Log Scale (/LG)

A logarithmic voltage that has been converted from a physical value is applied to the GM10, and then the GM10's Log scale (logarithmic scale) is used to display and record the physical value.

- Input type: Log input (logarithmic input), pseudo log input (input that supports pseudo logs), log linear input (input that is linear on a logarithmic scale)
- Range: 20mV/60mV/200mV/1V/2V/6V/20V/50V
- Scalable range:
 - Log input: 1.00E-15 to 1.00E+15 (15 decades maximum)
 - Scale_L < Scale_U
If the lower limit mantissa is 1.00, the difference between the exponents must be 1 or more.
If the lower limit mantissa is a value other than 1.00, the difference between the exponents must be 2 or more.
- Pseudo Log Input/Log linear input
 - 1.00E-15 to 1.00E+15 (15 decades maximum)
 - The upper limit mantissa is the same as the lower limit mantissa.
If the lower limit mantissa is 1.00, the value must be between 1.00E-15 and 1.00E+15, the difference between the exponents must be 1 or more, and the maximum decades is 15.
If the lower limit mantissa is a value other than 1.00, the value must be between 1.01E-15 and 9.99E+14, the difference between the exponents must be 1 or more and the maximum decades is 15.

- Alarm type: High limit, low limit, delay high limit, delay low limit
- Alarm setting range: The range converted into the LOG scale corresponding to -5% to 105% of the span width.
- Alarm hysteresis: Fixed to 0
- Green band setting range: The lower limit to the upper limit of the scale. However, the lower limit of the display position must be smaller than the upper limit.
- Decimal place: 1 or 2
- Misc: Nonlinear input is possible by correcting the input value.

EtherNet/IP Communication (PLC communication protocol) (/E1)

Can join an Ethernet/IP network as an adapter (or a server)

- Loading data of the I/O channel, math channel (/MT) and alarm status.
Note: Control alarm status cannot be loaded.
I/O channel: GM10-1: 100, GM10-2: 500
Math channel: GM10-1: 100, GM10-2: 200
- Loading and writing data from/to the communication channel (/MC)
Communication channel:
GM10-1: 300, GM10-2: 500
- Implementation level: Level 2
- Operations that can be performed using explicit messages:
Communication is performed using the CIP extension feature of the PLC-specific PCCC command by Rockwell Automation.
Start and stop recording and computation
Write batch information
Write messages
Load alarm status
Write alarm setpoints and alarm types
Alarm ACK
Note: The following operations are not possible: load control alarm status, write control alarm setpoints and control alarm types, control alarm ACK.
- Number of the simultaneous connection: Max. 10 (Explicit message)
- Supported protocols: EIP/PCCC, EIP/native

WT Communication (/E2)

Acquires data by connecting to WT equipment manufactured by Yokogawa Test & Measurement Corp. via Ethernet communication.

- Supported models: WT1800, WT500, WT300
- Number of connectable units: 16
- Communication cycle:
500 ms/1 s/2 s/5 s/10 s/20 s/30 s
- Types of data that can be obtained: Voltage, current, power, power factor, phase, electrical energy, high-frequency wave, etc.
- Number of data allocations: 300

Multi-batch Function (/BT)

Recording start/stop and data file creation is possible for each batch.

- Number of multi batches
GM10-1: 6 max., GM10-2: 12 max.
- Batch single operation: Memory start/stop, math reset, message writing

- Batch overview operation: Computation start/stop, report start/stop, manual sampling, setup data save/load
- Scan interval: 500 ms, 1 s, 2 s, 5 s (common to all batches)
- Data type: Display or event only Trigger mode not available for event data.
- Recording interval: Common to all batches
- Data file: Display or event data file created for each batch
- Number of display groups:
GM10-1: 6 max. per batch
Number of channels per group: 20
GM10-2: 12 max. per batch
Number of channels per group: 20
Channels assigned to the display group of each batch and those set as recording channels are recorded to data files.
- Batch single settings: Group, trip line, file header, data file name, text field, batch number, lot number
- Measurement mode limitations: Measurement modes High speed and Dual interval cannot be used.

Aerospace Heat Treatment (/AH)

Supports heat treatment application AMS2750/NADCAP

Schedule management for periodically executing calibration correction configuration and the like
In correction coefficient mode of calibration correction, two biases can be specified: one based on thermocouple and another based on device

- Number of manageable schedules
GM10-1: 6 max., GM10-2: 12 max.
 - Calibration correction mode: Off, linearizer approximation, linearizer bias, correction coefficient
- Number of set points: 2 to 12

OPC-UA Server (/E3)

Data acquired by the GM can be accessed through Ethernet communication from a host system (OPC-UA client).

- Communication
Type: OPC-UA Server
Encoding: UA Binary
Protocol: OPC UA TCP
Maximum number of connections: 3 sessions
Profile: Micro Embedded Device Server
- Security
Mode: None
Encryption: None
Login: Anonymous, Username
- Data acquisition:
Measurement value, alarm status, alarm value
Computation value, alarm status, alarm value
Communication value, alarm status, alarm value
Batch information
- Data writing: Measurement channel (DO channel only), communication channel, alarm value, batch information
- Other acquired information: Device name, serial number, time, device status
- Port number: 4840 (changeable: 1 to 65535)
- Number of items: 300 max. (MonitoredItem/Session)
- Fastest period: 100 ms

- Service set:

Discovery	FindServers, GetEndpoints
SecureChannel	OpenSecureChannel, CloseSecureChannel
Session	CreateSession, ActivateSession, CloseSession
View	Browse, BrowseNext, TranslateBrowsePathsToNodeIds
Attribute	Read, Write
MonitoredItem	CreateMonitoredItems, ModifyMonitoredItems, DeleteMonitoredItems, SetMonitoringMode
Subscription	CreateSubscription, ModifySubscription, DeleteSubscriptions, Publish, Republish, SetPublishingMode

- When a PID control module is installed, loop objects are displayed in place of channel objects.
Data collection: PV, SP, OUT, R/S, A/M/C, R/L, alarm status in loops
Data saving: OUT, R/S, A/M/C, R/L

SLMP Communication (Mitsubishi PLC) (/E4)

Protocol function of CC-Link family that enables connection from GM to Mitsubishi Electric PLC without sequencer program.

The GM operates as an SLMP client. Writing GM measurement data to a PLC and reading PLC data into communication channels* are possible.

* The communication channel function (/MC option) is required.

- Number of connection destination servers: 16 max.
- Read cycle: 100 ms, 200 ms, 500 ms, 1 s, 2 s, 5 s, 10 s, 20 s, 30 s, 1 min
- Number of commands that can be registered:
GM10-1: 100
GM10-2: 200
- Communicable internal data:
Special relay (SM), special register (SD), input (X), output (Y), internal relay (M), latch relay (L), annunciator (F), edge relay (V), link relay (B), data register (D), link register (W), timer contact (TS), timer coil (TC), current timer value (TN), integration timer contact (SS), integration timer coil (SC), current integration timer value (SN), counter contact (CS), counter coil (CC), current counter value (CN), special link relay (SB), special link register (SW), direct access input (DX), direct access output (DY), index register (Z), file register (R, ZR), extended data register (D), extended link register (W)

Device code is indicated in parentheses.

Program Control Function (/PG)

See the PID Control Module General Specifications (GS 04L53B01-31EN).

PROFINET Communication Function (when GX90NW is installed)

See the Network Module General Specifications (GS 04L53B51-01EN).

Integration Bar Graph Function (/WH)

The integration bar graph function reads the report file (a hourly report or hourly report / daily report) stored on the SD card of GM 10 and displays the integration bar graph and the integration trend in the web application.

- Report file monitoring and display update interval:
5 minutes

GM10 HARDWARE SPECIFICATIONS

- Material: Polycarbonate
- Color:
Case: Smoke blue (Munsell 4.1PB 6.0/4.5 equivalent)
Front panel: Light charcoal gray (Munsell 10B 3.6/0.3 equivalent)
- External Dimensions: 45.1(W)×111(H)×107.1(D) mm
- Weight: Approx. 0.25 kg

Power Supply and Isolation

- Power supply: Supplied from the GM90PS Power Supply Module
- Power consumption: 2.8 W maximum
- Insulation resistance: Between RS-422/485 terminal and internal circuit and between Ethernet terminal and internal circuit, 20 MΩ or higher at 500 V DC
- Isolation diagram

RS-422/485 terminal (/C3 option)	Internal circuit GM90PS ground terminal
Ethernet port	

Circuits delimited by lines are mutually isolated.

Other Specifications

- Memory backup: A built-in lithium battery backs up the settings and runs the clock.

External Dimensions

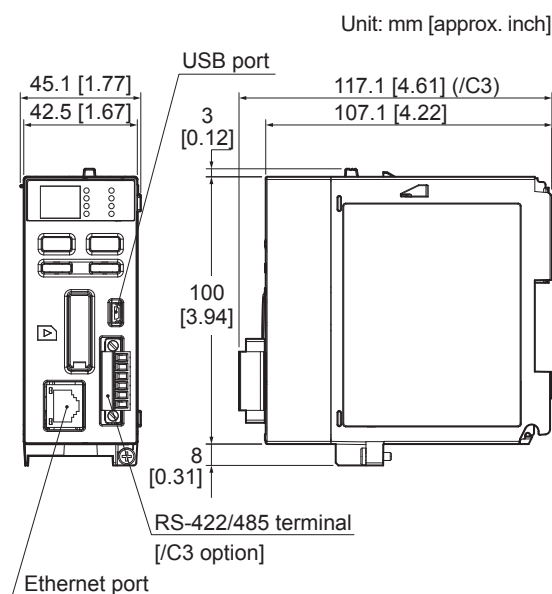

GM90MB MODULE BASE SPECIFICATIONS

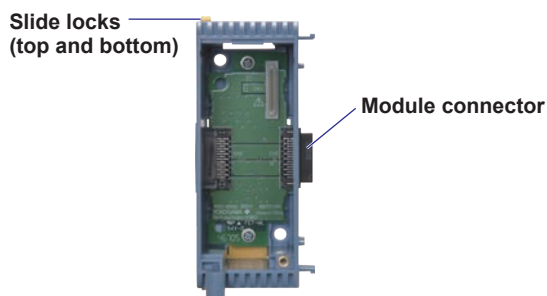

- Number of installable modules: 1
- Power consumption: Less than 0.01 W
- Automatic module number assignment function: Automatically assigns a module number when a module is connected
- Material: Polycarbonate
- Color: Smoke blue (Munsell 4.1PB 6.0/4.5 equivalent)
- External Dimensions: 57.7(W)×135(H)×103.5(D) mm
- Weight: Approx. 0.15 kg

External Dimensions

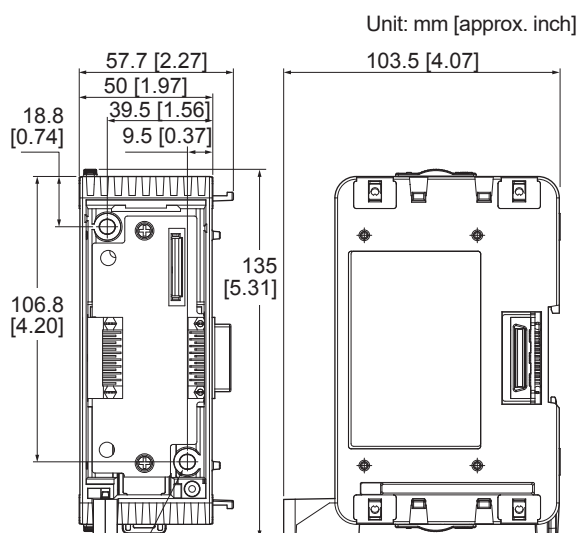

2- ϕ 5.5[0.22]×5.9[0.23]
Oval hole
for wall mounting

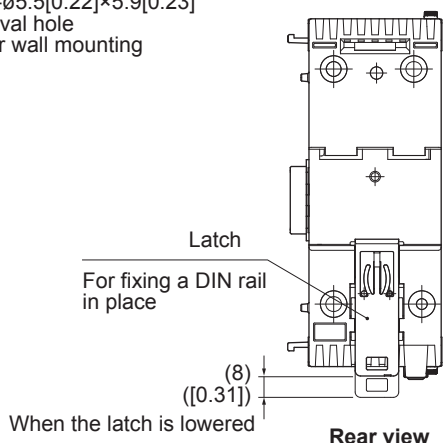

GM90PS POWER SUPPLY MODULE SPECIFICATIONS

Unit: mm

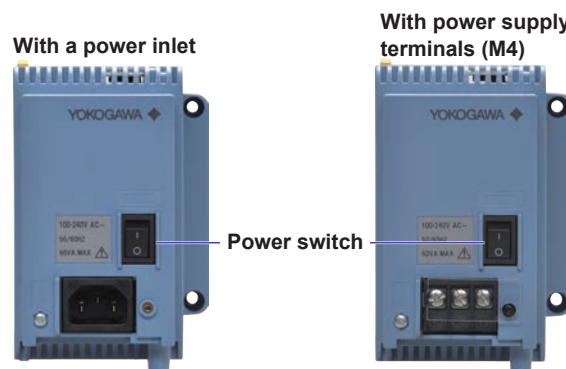

GM90PS-1N1□0

- Rated supply voltage: 100 to 240 VAC
- Allowable supply voltage: 90 to 264 V AC
- Power frequency: 50 Hz \pm 2%, 60 Hz \pm 2%
- Power switch: Available
- Terminal type: Inlet or M4 screw terminal
- Allowable interruption time: Less than 1 cycle of the power supply frequency
- Insulation resistance: Between the power supply terminal and earth: 20 M Ω or higher at 500 V DC
- Withstand voltage: Between the power supply terminal and earth: 3000 V AC (50/60 Hz) for 1 minute
- Grounding: Be sure to set a low grounding resistance.
- Material: Polycarbonate
- Color: Smoke blue (Munsell 4.1PB 6.0/4.5 equivalent)
- External Dimensions: 56.8(W)×135(H)×107.1(D) mm
- Weight: Approx. 0.55kg

GM90PS-1N2W0

- Rated supply voltage: 12 to 28 V DC
- Allowable supply voltage: 10 to 32 V DC
- Power frequency: 50 Hz \pm 2%, 60 Hz \pm 2%
- Power switch: Available
- Terminal type: M4 screw terminal
- Allowable interruption time: 2 ms or less
- Insulation resistance: Between the power supply terminal and earth: 20 M Ω or higher at 500 V DC
- Withstand voltage: Between the power supply terminal and earth: 1000 V AC (50/60 Hz) for 1 minute
- Grounding: Be sure to set a low grounding resistance.
- Material: Polycarbonate
- Color: Smoke blue (Munsell 4.1PB 6.0/4.5 equivalent)
- External Dimensions: 56.8(W)×135(H)×107.1(D) mm
- Weight: Approx. 0.55kg

• External Dimensions

Unit: mm [approx. inch]

With a power inlet

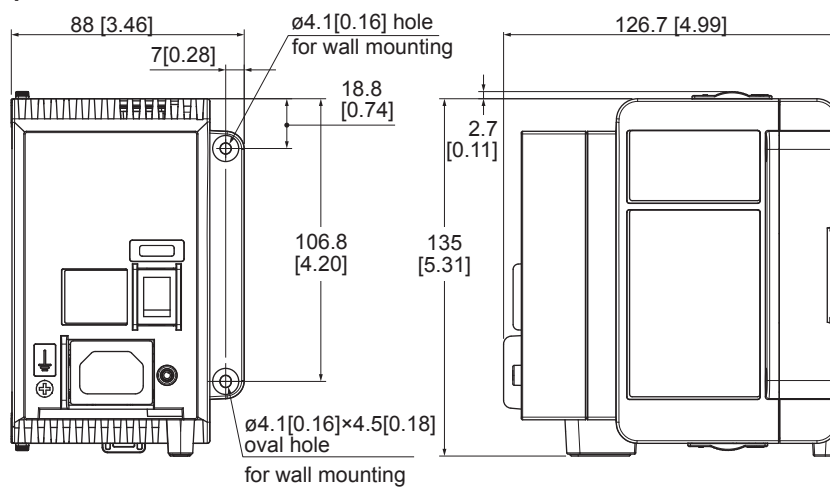

With power supply terminals (M4)

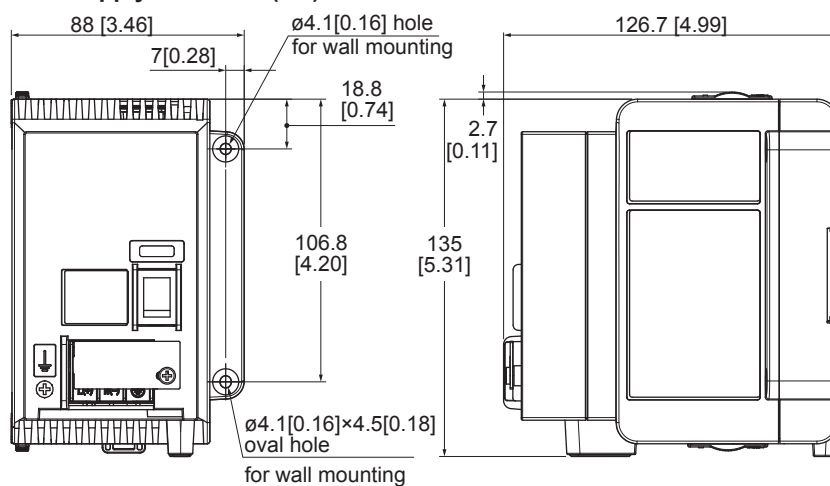

Rear view

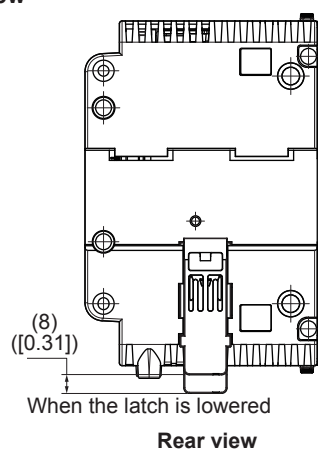

UNIT EXTERNAL DIMENSIONS

Unit: mm [approx. inch]

• Main unit (single unit)

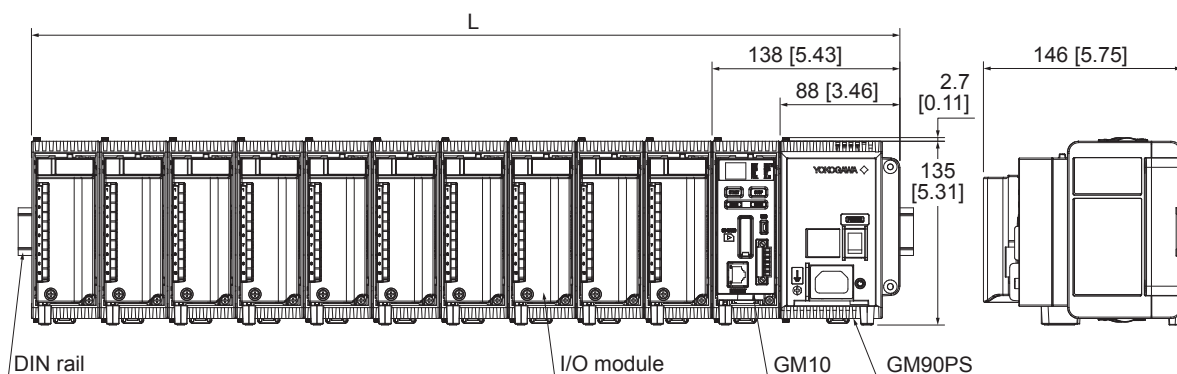

• Main unit (multi unit)

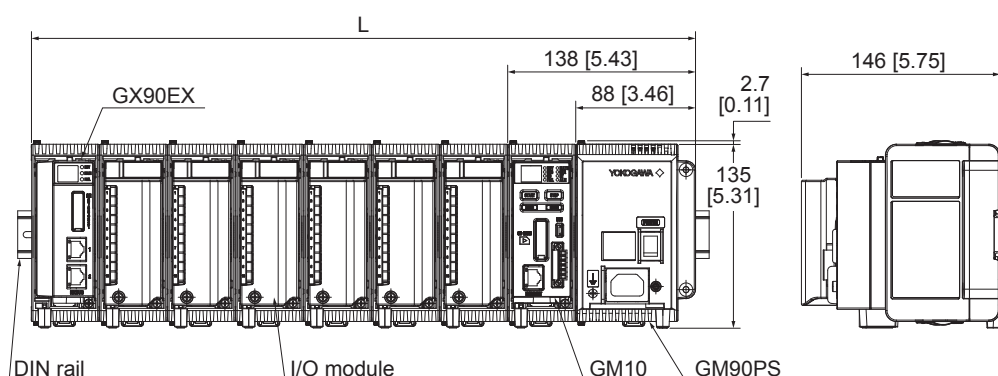

• Sub unit

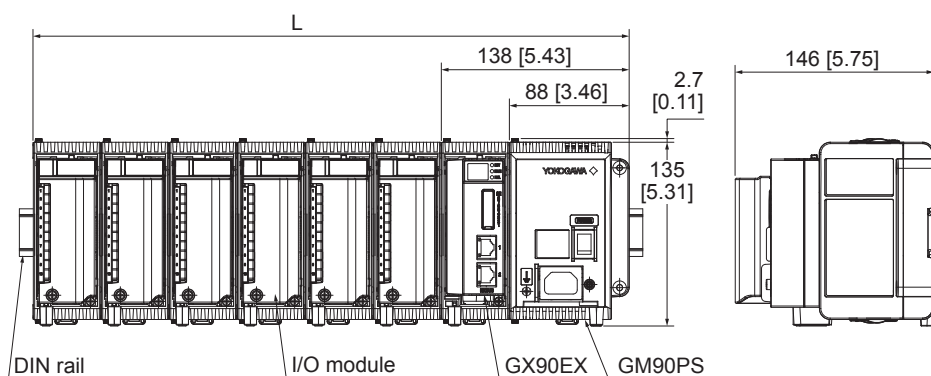

Unit: mm
approx. inch

Unit types	Maximum width for each input / output module to be connected: L (mm)										
	0	1	2	3	4	5	6	7	8	9	10
Main unit (single unit)	138 5.43	188 7.40	238 9.37	288 11.34	338 13.31	388 15.28	438 17.24	488 19.21	538 21.18	588 23.15	638 25.12
Main unit (multi unit)	188 7.40	238 9.37	288 11.34	338 13.31	388 15.28	438 17.24	488 19.21				
Sub unit (multi unit)	138 5.43	188 7.40	238 9.37	288 11.34	338 13.31	388 15.28	438 17.24				

• Vertical Mounting Dimensions for DIN Rail Mounting

Unit: mm [approx. inch]

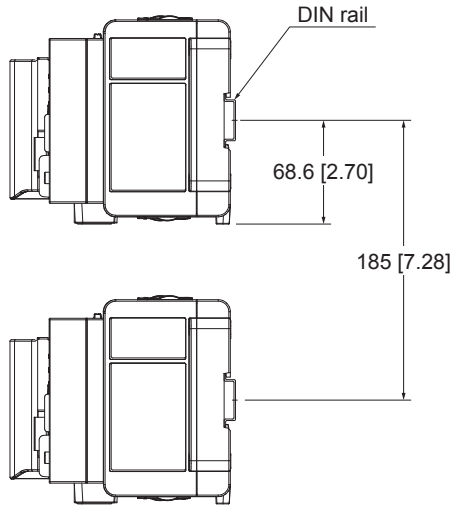

• Wall Mount Dimensions

Unit: mm [approx. inch]

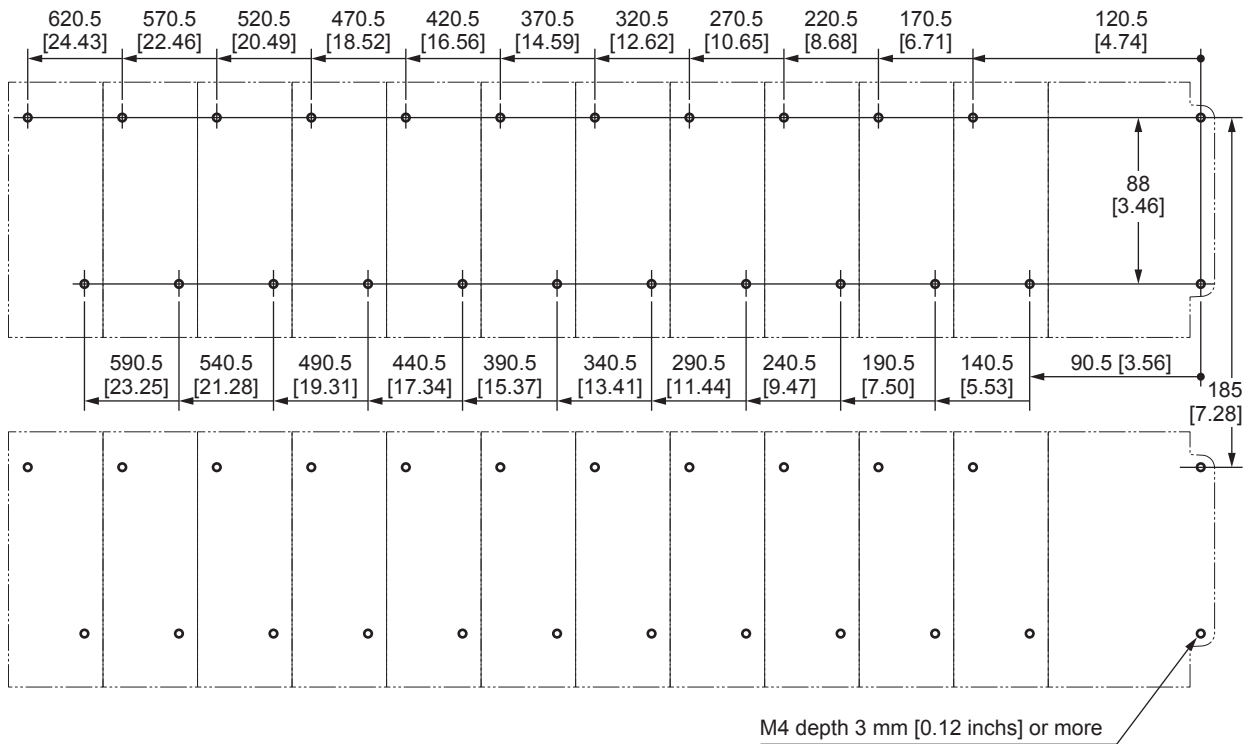

Tolerance: ± 0.3 [± 0.012]

APPLICATION SOFTWARE

SMARTDAC+ STANDARD

- Universal Viewer
- Hardware Configurator
- IP Address Configurator

Download the latest version of the software from the following URL.

www.smartdacplus.com/software/en/

PC System Requirements

Operating system:

Item	Specifications
Windows 10	Home (32-bit and 64-bit editions)
	Pro (32-bit and 64-bit editions)
	Enterprise LTSC (32-bit and 64-bit editions)
	Enterprise LTSC (32-bit and 64-bit editions)
Windows 11	Home (64-bit edition)
	Pro (64-bit edition)
	Enterprise (64-bit edition)

Processor and main memory:

OS	Processor and main memory
Windows 10	32-bit edition: Intel Core2 Duo E6300 or faster x64 or x86 processor. At least 2 GB.
	64-bit edition: Intel Core2 Duo E6300 or faster x64 or x86 processor. At least 2 GB.
Windows 11	Intel Core i5 or faster, and 8th generation or later Intel processor.

Web browser:

Supported browser: Microsoft Edge, Google Chrome

Hard disk:

100 MB or more free space for Windows 10

64 GB or more free space for Windows 11 (depending on the amount of data, you may need more memory).

Display:

A video card that is recommended for the OS and a display that is supported by the OS, has a resolution of 1024 x 768 or higher, and that can show 65,536 colors (16-bit, high color) or more.

Universal Viewer

The universal viewer can display the following data generated by data loggers or recorders on the screen and print it out on the printer.

- Display data file
- Event data file
- Report data file
- Manual sampled data file

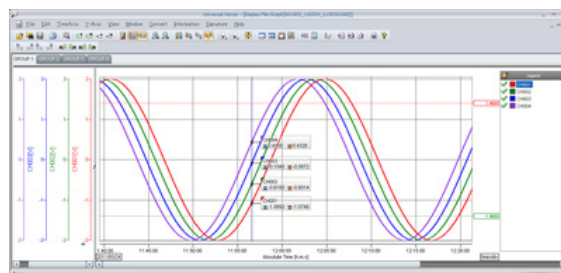

- Viewer function: Waveform display, digital display, circular display, list display, report display, operation log display, waveform superimposed display, etc.
- Data conversion: File conversion to Excel and ASCII format
- Signature function: Signing measurement data files is possible.

Hardware Configurator

- Offline setting on Web browser
Settings can be configured from Microsoft Edge and Google Chrome.

Channel	Type	Range	Input Limit	Input Upper	Calculation	Reference Point
0001	Yield	2V	-2.0000	2.0000	OUT	0001.0
0002	Yield	2V	-2.0000	2.0000	OUT	0001.0
0003	Yield	2V	-2.0000	2.0000	OUT	0001.0
0004	Yield	2V	-2.0000	2.0000	OUT	0001.0
0005	Yield	2V	-2.0000	2.0000	OUT	0001.0
0006	Yield	2V	-2.0000	2.0000	OUT	0001.0
0007	Yield	2V	-2.0000	2.0000	OUT	0001.0
0008	Yield	2V	-2.0000	2.0000	OUT	0001.0
0009	Yield	2V	-2.0000	2.0000	OUT	0001.0
0010	Yield	2V	-2.0000	2.0000	OUT	0001.0

IP Address Configurator

- GM10 IP address assignment
Edit the GM10's host name, IP address, DNS server, domain name, domain suffix, and so on as well as register the host name to a DNS server.
- GM10 search Search for GMs in the same network segment and list them.

MODEL AND SUFFIX CODES

GM10 Model and Suffix Codes

Model	Suffix code	Optional code	Description
GM10			Data Acquisition Module for SMARTDAC+ GM
Type	-1		Standard (Max. measurement channels: 100)
	-2		Large memory (Max. measurement channels: 500)
Area	E		General
—	0		Always zero
Optional features	/AH		Aerospace heat treatment
	/AS		Advanced security function ^{*5}
	/BT		Multi-batch function ^{*4}
	/C3		RS-422/485
	/C8		Bluetooth
	/E1		EtherNet/IP communication (PLC communication protocol) ^{*7}
	/E2		WT communication ^{*1}
	/E3		OPC-UA sever
	/E4		SLMP communication (Mitsubishi PLC) ^{*8}
	/LG		Log scale
	/MC		Communication channel function ^{*9 *11}
	/MT		Mathematical function (with report function) ^{*2 *3}
	/PG		Program control function ^{*6}
	/WH		Integration bar graph function ^{*10}

- *1 If you specify WT communication, you must also specify the communication channel function (/MC option).
- *2 Optional code /MT (MATH) required if using the GX90XD's or GX90WD's pulse input.
- *3 Optional code /MT (MATH) required if using the GX90XP's pulse integration.
- *4 When the advanced security function is set to ON, the scan interval is set to 100 ms or longer. In addition, the dual interval function and PID modules cannot be used.
- *5 When the multi-batch function is set to ON, the scan interval is set to 500 ms or longer. In addition, the dual interval function cannot be used.
- *6 A PID control module is required to use the program control function.
- *7 If you want to write from a PLC to the GM via EtherNet/IP communication, a communication channel (/MC) is required.
- *8 If you want to read PLC data to communication channel via SLMP communication, a communication channel (/MC) must be specified.
- *9 A communication channel (/MC) is required to configure the Modbus client function and for other devices to write to the GM Modbus server.
- *10 If you specify /WH option, you must also specify the communication channel function (/MC option) and the mathematical function (/MT option).
- *11 A communication channel (/MC) is required to use the profile function.

GM90PS Model and Suffix Codes

Model	Suffix Code	Optional code	Description
GM90PS			Power Supply Module for SMARTDAC+ GM
Type	-1		Always -1
Area	N		General
Supply voltage	1		100-240 V AC
	2		12-28 V DC ^{*1}
Power supply connection	D		Power inlet with UL/CSA cable
	F		Power inlet with VDE cable
	H		Power inlet with GB cable
	N		Power inlet with NBR cable
	Q		Power inlet with BS cable
	R		Power inlet with AS cable
	W		Screw terminal (M4) (without power cable)
—	0		Always zero
Optional features	/WH		For Integration bar graph function ^{*2}

*1 Only W (Screw terminal (M4)) is available for the power supply connection.

*2 When using with GM10 (/WH option), it is necessary to specify the /WH option (for integrated bar graph function) for GM90PS.

GM90MB Model and Suffix Codes

Model	Suffix Code	Description
GM90MB		Module Base for SMARTDAC+ GM
—	-01	Always -01
Area	N	General
—	0	Always zero

ORDERING INFORMATION

Model, suffix code, and optional codes, when necessary, are required to be specified.

Note 1: For modules other than GM90PS (power supply module), a GM90MB (module base) is required for each module.

Note 2: Before ordering, read "MODEL SELECTION GUIDE" on page 24 and "Restrictions and Cautions" on page 26.

STANDARD ACCESSORIES

Model	Standard accessory name	Qty
GM10	SD card (1 GB)	1
GM90PS	Connector cover	1
	Power cable (depends on the suffix code of the power supply connection)	1
	Interconnect screw (M3)	4
GM90MB	Interconnect screw (M3)	4

■ OPTIONAL ACCESSORIES (SOLD SEPARATELY)

Product	Model/part no.
SD card (1 GB)	773001
Shunt resistor for M3 terminal (250 $\Omega \pm 0.1$ %)	415940
Shunt resistor for M3 terminal (100 $\Omega \pm 0.1$ %)	415941
Shunt resistor for M3 terminal (10 $\Omega \pm 0.1$ %)	415942
Shunt resistor for clamp terminal (250 $\Omega \pm 0.1$ %)	438920
Shunt resistor for clamp terminal (100 $\Omega \pm 0.1$ %)	438921
Shunt resistor for clamp terminal (10 $\Omega \pm 0.1$ %)	438922
Dummy cover	B8740CZ
Validation Documents (For /AS option) *1	773230

*1 Provision of Validation Documents A license sheet containing the license key required for installation is provided. Download the validation document from the following URL.
<http://www.smartdacplus.com/software/en/>

Related Product (Sold Separately)

Model	Description
GA10	Data Logging Software OS: Windows 8.1/10/11 Windows Server 2012/2016/2019
CE10	Cloud Equipment/Quality Prediction Tool OS: Windows 10/11
OE10	Offline Equipment/Quality Prediction Tool OS: Windows 10/11

Test Certificate (QIC, sold separately)

QIC is available for each model.

User's Manual

Product user's manuals can be downloaded or viewed at the following URL. To view the user's manual, you need to use Adobe Acrobat Reader (the latest version recommended).

URL: www.smartdacplus.com/manual/en/

Trademarks

The TCP/IP software used in this product and the document for that TCP/IP software are based in part on BSD networking software, Release 1 licensed from The Regents of the University of California.

SMARTDAC+ is a registered trademark or trademark of Yokogawa Electric Corporation.

Microsoft, MS, Microsoft Edge and Windows are trademarks or registered trademarks of Microsoft Corporation in the United States and/or other countries.

Intel Core is a trademark of Intel Corporation in the United States and/or other countries.

Modbus is a registered trademark of Schneider Electric.

Kerberos is a trademark of MIT.

Bluetooth is a trademark or registered trademark of Bluetooth SIG Inc.

Google Chrome is a trademark or registered trademark of Google LLC.

Other company names and product names appearing in this document are registered trademarks or trademarks of their respective holders.

The company and product names used in this manual are not accompanied by the registered trademark or trademark symbols (® and ™).

MODEL SELECTION GUIDE

Selection of the system configuration and GM10 type

Model-Type	Internal memory	System Configuration	I/O channels
GM10-1	500MB	Single Unit	0 to 100ch
		Multi Unit	0 to 100ch
GM10-2	1.2GB	Single Unit	0 to 100ch
		Multi Unit	0 to 420ch



I/O Modules

Model	Suffix code	Product name	Description	Number of channels	Measurement interval (shortest)
GX90XA	-10-C1N-□N	Analog Input Module	Current (mA) input: DC current (mA), DC current standard signal (4-20 mA)	10	100 ms
	-10-L1N-□N		Low withstand voltage relay: DC voltage, standard signal, thermocouple (TC), DI (voltage, contact), and DC current (by adding an external shunt resistor)		500 ms
	-10-U2N-□N		Universal: DC voltage, standard signal, thermocouple (TC), resistance temperature detector (RTD), DI (voltage, contact), and DC current (by adding an external shunt resistor)		100 ms
	-10-T1N-□N		Electromagnetic relay: DC voltage, standard signal, thermocouple (TC), DI (voltage, contact), and DC current (by adding an external shunt resistor)		1 s
	-10-V1N-□N		High withstand voltage: DC voltage, standard signal, thermocouple (TC), DI (voltage, contact), and DC current (by adding an external shunt resistor)		100 ms
	-04-H0N-□N		High-speed universal: DC voltage, standard signal, thermocouple, resistance temperature detector (RTD), DI (voltage, contact), DC current (when an external shunt resistor is connected)		4
	-06-R1N-□N		4-wire RTD, 4-wire resistance	6	100 ms
GX90XD	-16-11N-□N	Digital Input Module	Remote control input, pulse input	16	100 ms
GX90XP	-10-11N-□N	Pulse Input Module	Pulse input (flow sum and the like)	10	100 ms
GX90YD	-06-11N-3N	Digital Output Module	Alarm output, etc	6	100 ms (update interval)
GX90WD	-0806-01N-3N	Digital Input/Output Module	Remote control input, pulse input	DI: 8 DO: 6	100 ms
GX90XP	-10-11N-□N	Pulse Input Module	Pulse input (flow sum and the like)	10	100 ms
GX90YA	-04-C1N-□N	Analog Output Module	Transmission output, manual output	4	100 ms(update interval)
GX90UT	-02-11N-3N	PID Control Module	Control of temperature, flow, pressure etc.	2 loops	100 ms(update interval)

Single unit system configuration (up to 100 channels)

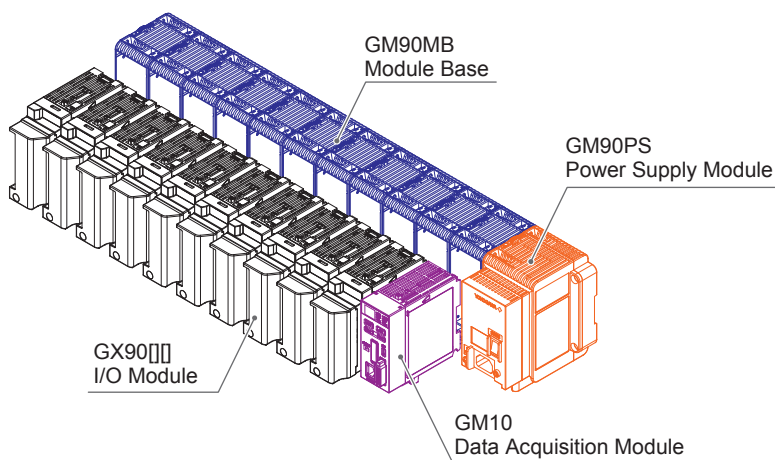

Configuration example (maximum)

GM10: 1
GM90PS: 1
GX90□□: 10
GM90MB: 11

9	8	7	6	5	4	3	2	1	0	<---Slot number
GM90MB	GM90MB	GM90MB	GM90MB	GM90MB	GM90MB	GM90MB	GM90MB	GM90MB	GM90MB	GM90MB
GX90□□	GX90□□	GX90□□	GX90□□	GX90□□	GX90□□	GX90□□	GX90□□	GX90□□	GX90□□	GM10
										GM90PS

Multi unit system configuration (up to 420 channels)

Main unit

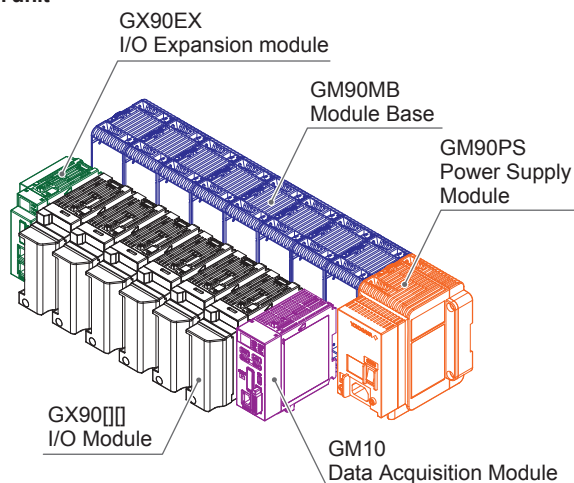

Sub unit

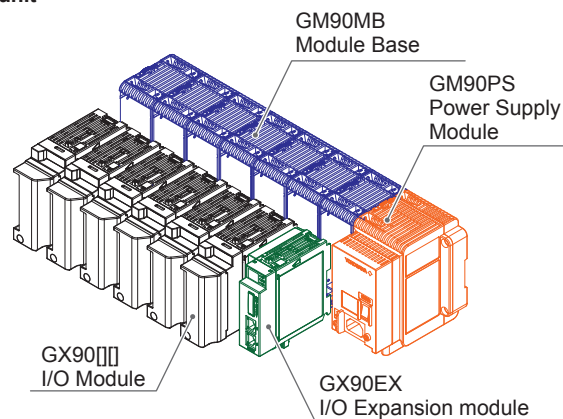

Main unit configuration example (maximum)

- GM10: 1
- GM90PS: 1
- GX90: 6
- GX90EX: 1
- GM90MB: 8

Sub unit configuration example (maximum)

- GM90PS: 6
- GX90: 36
- GX90EX: 6
- GM90MB: 42

	5	4	3	2	1	0	<---Slot number		
Main Unit (Unit 0)	GM90MB	GM90MB	GM90MB	GM90MB	GM90MB	GM90MB	GM90MB	GM90MB	GM90PS
	GX90EX	GX90	GX90	GX90	GX90	GX90	GX90	GM10	

	5	4	3	2	1	0	<---Slot number	
Sub Unit (Unit 1)	GM90MB	GM90MB	GM90MB	GM90MB	GM90MB	GM90MB	GM90MB	GM90PS
	GX90	GX90	GX90	GX90	GX90	GX90	GX90EX	

	5	4	3	2	1	0	<---Slot number	
Sub Unit (Unit 2)	GM90MB	GM90MB	GM90MB	GM90MB	GM90MB	GM90MB	GM90MB	GM90PS
	GX90	GX90	GX90	GX90	GX90	GX90	GX90EX	

	5	4	3	2	1	0	<---Slot number	
Sub Unit (Unit 3)	GM90MB	GM90MB	GM90MB	GM90MB	GM90MB	GM90MB	GM90MB	GM90PS
	GX90	GX90	GX90	GX90	GX90	GX90	GX90EX	

	5	4	3	2	1	0	<---Slot number	
Sub Unit (Unit 4)	GM90MB	GM90MB	GM90MB	GM90MB	GM90MB	GM90MB	GM90MB	GM90PS
	GX90	GX90	GX90	GX90	GX90	GX90	GX90EX	

	5	4	3	2	1	0	<---Slot number	
Sub Unit (Unit 5)	GM90MB	GM90MB	GM90MB	GM90MB	GM90MB	GM90MB	GM90MB	GM90PS
	GX90	GX90	GX90	GX90	GX90	GX90	GX90EX	

	5	4	3	2	1	0	<---Slot number	
Sub Unit (Unit 6)	GM90MB	GM90MB	GM90MB	GM90MB	GM90MB	GM90MB	GM90MB	GM90PS
	GX90	GX90	GX90	GX90	GX90	GX90	GX90EX	

■ RESTRICTIONS AND CAUTIONS

Limit to the number of modules and number of channels in the system

System	Measurement mode	Maximum Number of Connections Module	Maximum Number of Channels			
			I/O	Communication	Math	Report
GM10-1	Normal	10	100	300	100	60
	High speed	8	32			
	Dual interval	10	50	150	50	30
GM10-2	Normal	42	500	500	200	60
	High speed	8	32			
	Dual interval	42	250	250	100	30

Limit to the number of modules per unit

The following table shows the limits when the module specified under Module is connected to the system. The system will not operate if the limit is exceeded.

Module	Single unit system	Multi unit system
	Main unit	Main unit
When GX90XA-10-T1 is included	Up to 8	No limit
When GX90XA-04-H0 is included	Up to 8	No limit
When GX90XA-04-H0 and GX90YA are included	Up to 7	No limit
When GX90UT is included	Up to 5	Up to 5

Limit to the Number of Sub Units

- Up to six units can be connected.
- Connection is not possible if the measurement mode is set to High speed.

Limit on Modules

- Up to 10 modules consisting of GX90YD, GX90WD, and GX90UT can be connected to the system.
- One GX90WD module can be connected to each unit.
- Two GX90YA modules can be connected to the main unit and to the sub unit.
- Up to 10 GX90YA modules can be connected to a GM10-1 system and up to 12 to a GM10-2 system.
- If the measurement mode is High speed, a GX90XD or GX90WD module can be connected to the system.
- If the measurement mode is High speed, only GX90XA-04-H0 (high-speed AI), GX90XD (DI), GX90WD (DIO), and GX90NW are detected.
- DI and DIO are fixed to remote mode. Measurement and recording are not possible.
- If the measurement mode is Dual interval, GX90UT is not detected.
- Up to 3 GX90UT modules can be connected to a GM10-1 system and up to 10 to a GM10-2 system.

Restrictions when using the GX90NW network module (protocol: PROFINET)

- One module of GX90NW can be used for the main unit (single unit) only. It must be connected to the leftmost slot when facing the front of the main unit.
- The GX90NW cannot be used at the same time as the expansion module (GX90EX).
- When including the GX90XA or GX90YA, you can mount up to 6 modules including the GX90NW.

Notes on Module Installation

- If you want to use reference junction compensation on a thermocouple input of a GX90XA-10-U2, GX90XA-10-L1, GX90XA-10-T1 or GX90XA-10-V1, do not connect the following module to the right of the GX90XA module as seen from the front. Doing so may cause the reference junction compensation accuracy to deviate from the guaranteed range.
GX90XA-10-C1 (for mA), GX90XA-04-H0 (high-speed AI), GX90YA, GX90WD, GX90UT
- If the maximum number of I/O channels are assigned and the last channel is assigned to an intermediate channel of a connected I/O module, that module and subsequent modules will not be identified.

GM10-1

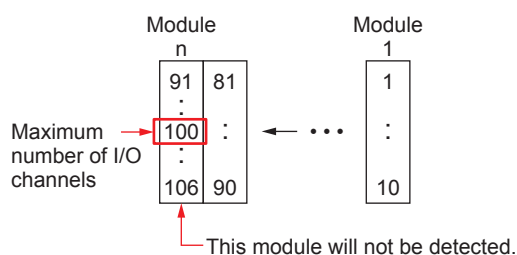

- If you want to use the DI of a GX90XD or GX90WD, only a single module installed in the GM main unit can be used.

Limit to the Number of Measurement Channels

There is a limit to the number of channels that can measure at scan intervals shorter than 100 ms.

• When the measurement mode is set to High speed.

GM10-1

Channel	1 ms	2 ms	5 ms	10 ms	20 ms	50 ms
I/O	1	2	5	10	20	32
Math	1	2	5	10	20	50
Communication	3	6	15	30	60	150
Report	1	2	5	10	20	50

GM10-2

Channel	1 ms	2 ms	5 ms	10 ms	20 ms	50 ms
I/O	5	10	25	32	32	32
Math	2	4	10	20	40	100
Communication	5	10	25	50	100	250
Report	2	4	10	20	40	60

• When the measurement mode is set to Dual interval.

GM10-1

Channel	1 ms	2 ms	5 ms	10 ms	20 ms	50 ms
I/O	-----	-----	5	10	20	32
Math	-----	-----	2	5	10	25
Communication	-----	-----	7	15	30	75
Report	-----	-----	2	5	10	25

GM10-2

Channel	1 ms	2 ms	5 ms	10 ms	20 ms	50 ms
I/O	5	10	25	32	32	32
Math ^{*1}	1	2	5	10	20	50
Communication ^{*1}	2	5	12	25	50	125
Report ^{*2}	1	2	5	10	20	30

*1 Channels that can be used only on one of the two scan groups. They operate at the scan interval specified in the master scan group.

*2 Can be specified from 30 channels.

Limit to the Number of Recording Channels in Each Measurement Mode

I/O channel + math channel + communication channel

System	Measurement mode	1ms	2ms	5ms	10ms	20ms	50ms	100ms	200ms	500ms	1 s or more
GM10-1	Normal	-----	-----	-----	-----	-----	-----	100	200	500	500
	High speed	2	4	10	20	40	100	100	200	500	500
	Dual interval	-----	-----	5	10	20	50	100	100	250	250
GM10-2	Normal	-----	-----	-----	-----	-----	-----	500	500	1000	1000
	High speed	10	20	50	100	150	150	200	500	1000	1000
	Dual interval	5	10	25	40	50	50	100	200	600	600

Dual Interval Searching of Universal Viewer

Recording mode	Link dual interval waveform ^{*1}	Show dual interval waveform integrated link view ^{*2}
Free + Free	✓	✓
Free + Trigger (single-shot, repeated)	—	—
Trigger (single-shot, repeated) + Trigger (single-shot, repeated)	—	—

*1 Link dual interval waveform: A function that searches a folder for and displays the file that forms a pair with the displayed file.

*2 Show dual interval waveform integrated link view: A function that displays from the result of Search Open one of the files that forms a pair and displays both trends when it is clicked.

Program Pattern Setting (/PG option)

Hardware Configurator is required for setting program patterns. You cannot set using the Web application.

■ LIABILITY

YOKOGAWA assumes no liability to any party for any loss or damage, direct or indirect, caused by lost or missing data due to interrupted wireless or cable communication, or the use of the product outside the design, specifications, or handling conditions.

Except for the matters stipulated in the warranty of this product, YOKOGAWA does not guarantee any measurement data and operation taken when there is a failure, erroneous operation, and problem with the product.

■ Basic Conditions and Individual Contracts at the Time of Purchase

The warranty for this product is defined in the basic conditions and individual contracts at the time of purchase.

The individual conditions are as follows.

- **Validation**

Yokogawa does not guarantee the final outcome of validation work even if there is a defect in the product.

For the warranty of validation services, please contact the company that performed the validation work.

- **Warranty period of firmware**

The firmware warranty period is one year.

Please refer to the following URL for the procedure to update the firmware and the method to download the firmware.

<https://partner.yokogawa.com/global/>

General Specifications

GX90XA/GX90XD/GX90YD/
GX90WD/GX90XP/GX90YA
I/O Modules

SMARTDAC+TM

GS 04L53B01-01EN

OVERVIEW

I/O modules are connected to the GX/GP, Expandable I/O unit, GM main unit, and GM sub unit.

- A module type is seven types, an analog input, an analog output, a digital input, a digital output, a digital input/output and a pulse input PID control*.
 - * For the GX90UT PID Control Module, please see GX90UT PID Control Module General Specifications (GS 04L53B01-31EN.)
- Input and output have module structure and it can extend them easily.
- The GX90XA analog input module has the following types; (1) universal type that allows the measurement input for DCV (direct voltage), TC (thermocouple), RTD (resistance temperature detector), and DI (contact or TTL level voltage), (2) current input type with the built-in shunt resistor to directly input a standard signal of 4-20mA DC, (3) electromagnetic relay scanner type insusceptible to noises that allows the measurement input for DCV, TC, and DI, (4) low withstand voltage relay type that offers a low cost, (5) high withstand voltage type that 600 V withstand voltage between input terminal and ground.

The GX90XA-04-H0 high-speed analog input module can measure DCV (DC voltage), TC (thermocouple), RTD (resistance temperature detector), DI (contact or TTL level voltage) inputs at the shortest interval of 1 ms. It has an A/D converter for each input channel and employs a scannerless method, which is less susceptible to high frequency noise.

The GX90XA-06-R1 4-wire RTD/resistance input module can receive input from 4-wire RTDs or 4-wire resistors.

In each system, a measurement input signal can be assigned to each channel.
- The GX90YA analog output module is capable of retransmission output of various types of channels and also manual output. It provides current output with channels that are isolated.
- The GX90XD digital input module, which allows up to 16 digital inputs or pulse inputs, can be used as a multipoint digital input or pulse input. This module can also be used as a remote control input.
- The GX90YD digital output module is assigned as a relay output (contact C) and is used when an alarm activates. It can also be used to turn the output on and off manually using the touch panel.
- The GX90WD digital input/output module provides eight digital inputs or pulse inputs and six relay outputs. When there are small amounts of digital inputs and digital outputs, you do not need to mount two modules. This enables efficient channel configuration.
- GX90XP pulse input module can receive up to 10 pulse inputs. The maximum input frequency is 20 kHz. The module can be used to integrate pulse signals from flowmeters or the like.*
 - * Integration requires the math function (/MT option).



- Each module provides a M3 screw terminal and clamp terminal*. Also, the input terminal can be removed and mounted. This enables wiring work to be carried out efficiently.
 - * GX90YD and GX90WD are only M3 screw terminal.
- The measuring accuracies noted in the general specifications have a margin of error that takes into account the product's components and the equipment used for adjustment and testing. However, the actual values calculated from the accuracy testing data upon shipment of the instrument from the factory are as follows.

	Input Type	Measuring accuracy*1 (typical value*2)
DCV	20 mV	± (0.01% of rdg +5 μV)
	60 mV	± (0.01% of rdg +5 μV)
	6V (1-5V)	± (0.01% of rdg +2 mV)
TC ³	R, S	±1.1°C
	B	±1.5°C
	K (-200.0 to 1370.0°C)	± (0.01% of rdg +0.2°C for 0.0 to 1370.0°C; ± (0.15% of rdg +0.2°C) for -200.0 to 0.0°C
	K (-200.0 to 500.0°C)	±0.2°C for 0.0 to 500.0°C; ± (0.15% of rdg +0.2°C) for -200.0 to 0.0°C
	J	± 0.2°C for 0.0 to 1100.0 °C; ± (0.10% of rdg + 0.2 °C) for -200.0 to 0.0 °C
	T	± 0.2°C for 0.0 to 400.0°C; ± (0.10% of rdg + 0.2 °C) for -200.0 to 0.0 °C
	N	± (0.01% of rdg + 0.2°C) for 0.0 to 1300.0 °C; ± (0.22% of rdg + 0.2°C) for -200.0 to 0.0 °C
RTD	Pt100 (-200.0 to 850.0°C)	± (0.02% of rdg + 0.2°C)
	Pt100 (high resolution) (-150.00 to 150.00°C)	± (0.02% of rdg + 0.16°C)

rdg: Reading value

- *1 Applies to GX90XA-10-U2, A/D integration time 16.67 ms or more, General operating conditions: 23±2 °C, 55±10% RH, supply voltage 90–132, 180–264 V AC, power frequency within 50/60 Hz ±1%, warm-up of 30 minutes or more, no vibrations or other hindrances to performance.
- *2 For the measuring accuracy (guaranteed), see page 3 to 4.
- *3 These values do not include the reference junction compensation accuracy.

INPUT/OUTPUT MODULE SPECIFICATIONS

ANALOG INPUT MODULE (Model GX90XA or GX/GP main unit options /Uxx0)

The following notations are used to distinguish the various types.

Type Suffix Code	Notation
-U2	Universal
-C1	Current (mA) input
-L1	Low withstand voltage relay
-T1	Electromagnetic relay
-H0	High-speed universal
-R1	4-wire RTD/resistance
-V1	High withstand voltage



GX90XA

- Input Type:

Suffix Code	Input Type	Number of inputs	Description (Type)
-U2	DC voltage, standard signal, thermocouple (TC), resistance temperature detector (RTD), DI (voltage, contact), and DC current (by adding an external shunt resistor)	10	Universal
-C1	DC current (mA), DC current standard signal (4-20 mA)	10	Current (mA) input
-L1	DC voltage, standard signal, thermocouple (TC), DI (voltage, contact), and DC current (by adding an external shunt resistor)	10	Low withstand voltage relay
-T1	DC voltage, standard signal, thermocouple (TC), DI (voltage, contact), and DC current (by adding an external shunt resistor)	10	Electromagnetic relay
-H0	DC voltage, standard signal, thermocouple (TC), resistance temperature detector (RTD), DI (voltage, contact), and DC current (by adding an external shunt resistor)	4*1	High-speed universal
-R1	4-wire RTD, 4-wire resistance	6	4-wire RTD/resistance
-V1	DC voltage, standard signal, thermocouple (TC), DI (voltage, contact), and DC current (by adding an external shunt resistor)	10	High withstand voltage

*1 However, 1 point when the scan interval is 1 ms and 2 points when it is 2 ms.

- Input format: Floating unbalanced, isolation between channels (excluding the b terminal on universal and low withstand voltage relay type)
- Measurement interval: 1, 2, 5, 10, 20, 50, 100, 200, 500 ms, 1, 2, 5 s (See the table below.)

Scan interval by module

Suffix Code	Scan interval											
	1 ms	2 ms	5 ms	10 ms	20 ms	50 ms	100 ms	200 ms	500 ms	1 s	2 s	5 s
-U2	-	-	-	-	-	-	✓	✓	✓	✓	✓	✓
-C1	-	-	-	-	-	-	✓	✓	✓	✓	✓	✓
-L1	-	-	-	-	-	-	-	-	✓	✓	✓	✓
-T1	-	-	-	-	-	-	-	-	-	✓	✓	✓
-H0	✓	✓	✓	✓	✓	✓	✓	✓	✓	✓	✓	✓
-R1	-	-	-	-	-	-	✓	✓	✓	✓	✓	✓
-V1	-	-	-	-	-	-	✓	✓	✓	✓	✓	✓

- Input range: -5% or more and 105% or less (accuracy is guaranteed in the range from 0% to 100% inclusive)
- Operation mode

It is possible to switch to a mode that makes measurements by reducing the supply frequency noise.

Suffix Code	Operation mode
-U2	2 ch Only, Low noise mode or 10 ch Normal mode
-C1	2 ch Only, Low noise mode or 10 ch Normal mode
-L1	-
-T1	-
-H0	-
-R1	2 ch Only, Low noise mode or 6 ch Normal mode
-V1	2 ch Only, Low noise mode or 10 ch Normal mode

- Measurement ranges and accuracies^{*2} (However, the number of display digits can be increased by scaling.)

*2 The following specifications apply to operation of the recorder under standard operation conditions.

Temperature: 23 ± 2 °C, Humidity: 55% ± 10% RH, Power supply voltage: 90 to 132 or 180 to 264 VAC, Power supply frequency: 50/60 Hz ± 1%, Warm-up time: At least 30 min. Other ambient conditions such as vibration should not adversely affect recorder operation.

Reference junction compensation accuracy is not included for thermocouples.

Universal, Current (mA) input, Low withstand voltage relay, Electromagnetic relay, 4-wire RTD/resistor, High withstand voltage type

Input Type	Range	Measurement range	Measurement accuracy (digital display)		Max. resolution of digital display
			A/D integration time: 16.7ms or more ^{*22}	A/D integration time: 1.67ms ^{*23}	
DCV	20 mV	-20.000 to 20.000 mV	±(0.05 % of rdg + 12 µV)	±(0.1 % of rdg + 40 µV)	1 µV
	60 mV	-60.00 to 60.00 mV	±(0.05 % of rdg + 0.03 mV)	±(0.1 % of rdg + 0.15 mV)	10 µV
	200 mV	-200.00 to 200.00 mV	±(0.05 % of rdg + 0.03 mV)	±(0.1 % of rdg + 0.4 mV)	10 µV
	1 V	-1.0000 to 1.0000 V	±(0.05 % of rdg + 1.2 mV)	±(0.1 % of rdg + 4 mV)	100 µV
	2 V	-2.0000 to 2.0000 V	±(0.05 % of rdg + 1.2 mV)	±(0.1 % of rdg + 4 mV)	100 µV
	6 V	-6.000 to 6.000 V	±(0.05 % of rdg + 3 mV)	±(0.1 % of rdg + 15 mV)	1 mV
	20 V	-20.000 to 20.000 V	±(0.05 % of rdg + 3 mV)	±(0.1 % of rdg + 40 mV)	1 mV
	50 V	-50.00 to 50.00 V	±(0.05 % of rdg + 0.03 V)	±(0.1 % of rdg + 0.15 V)	10 mV
Standard signal	0.4-2 V	0.3200 to 2.0800 V	±(0.05 % of rdg + 1.2 mV)	±(0.1 % of rdg + 4 mV)	100 µV
	1-5 V	0.800 to 5.200 V	±(0.05 % of rdg + 3 mV)	±(0.1 % of rdg + 15 mV)	1 mV
DC current	0-20 mA	0.000 to 20.000 mA	±(0.3 % of rdg + 5 µA)	±(0.3 % of rdg + 90 µA)	1 µA
DC current (standard signal)	4-20 mA	3.200 to 20.800 mA			
TC (Excluding RJC accuracy)	R ⁻³	0.0 to 1760.0 °C	±(0.15 % of rdg + 1.0°C)	±(0.2 % of rdg + 6.0°C)	0.1°C
	S ⁻³	0.0 to 1760.0 °C	However, R, S; 0.0 to 800.0°C: ±2.2°C, B; 400.0 to 800.0°C: ±3.0°C	However, R, S; 0.0 to 800.0°C: ±7.6°C, B; 400.0 to 800.0°C: ±11.0°C	
	B ⁻³	0.0 to 1820.0 °C	Accuracy at less than 400.0°C is not guaranteed.	Accuracy at less than 400.0°C is not guaranteed.	
	K ⁻³	-270.0 to 1370.0 °C -200.0 to 500.0 °C	±(0.15 % of rdg + 0.7°C) However, -200.0 to 0.0°C: ±(0.35 % of rdg + 0.7°C) Accuracy at less than -200.0°C is not guaranteed	±(0.2 % of rdg + 5.0°C) However, -200.0 to 0.0°C: ±(3 % of rdg + 5.0°C) Accuracy at less than -200.0°C is not guaranteed	0.1°C
	E ⁻³	-270.0 to 800.0 °C	±(0.15 % of rdg + 0.5°C)	±(0.2 % of rdg + 4.0°C)	0.1°C
	J ⁻³	-200.0 to 1100.0 °C	However, -200.0 to 0.0°C: ±(0.35 % of rdg + 0.5°C) Accuracy at less than -200.0°C is not guaranteed	However, -200.0 to 0.0°C: ±(2 % of rdg + 4.0°C) Accuracy at less than -200.0°C is not guaranteed	
	T ⁻³	-270.0 to 400.0 °C	±(0.15 % of rdg + 0.5°C) However, -200.0 to 0.0°C: ±(0.35 % of rdg + 0.5°C) Accuracy at less than -200.0°C is not guaranteed	±(0.2 % of rdg + 2.5°C) However, -200.0 to 0.0°C: ±(2 % of rdg + 2.5°C) Accuracy at less than -200.0°C is not guaranteed	0.1°C
	N ⁻³	-270.0 to 1300.0 °C	±(0.15 % of rdg + 0.7°C) However, -200.0 to 0.0°C: ±(0.7 % of rdg + 0.7°C) Accuracy at less than -200.0°C is not guaranteed	±(0.3 % of rdg + 6.0°C) However, -200.0 to 0.0°C: ±(5 % of rdg + 6.0°C) Accuracy at less than -200.0°C is not guaranteed	0.1°C
	W ⁻⁴	0.0 to 2315.0 °C	±(0.15 % of rdg + 1.5°C)	±(0.3 % of rdg + 14.0°C) However, more than 1000.0°C: ±(0.8 % of rdg + 9.0°C)	0.1°C
	L ⁻⁵	-200.0 to 900.0 °C	±(0.15 % of rdg + 0.5°C) Less than 0.0°C: ±(0.5 % of rdg + 0.5°C)	±(0.2 % of rdg + 4.0°C) Less than 0.0°C: ±(3 % of rdg + 4.0°C)	0.1°C
	U ⁻⁵	-200.0 to 400.0 °C	±(0.15 % of rdg + 0.5°C) Less than 0.0°C: ±(0.7 % of rdg + 0.5°C)	±(0.2 % of rdg + 2.5°C) Less than 0.0°C: ±(3 % of rdg + 2.5°C)	0.1°C
	WRe3-25 ⁻⁶	0.0 to 2320.0 °C	±(0.2 % of rdg + 2.5°C)	±18.0°C More than 2000.0°C: ±0.9 % of rdg	0.1°C
	KpvsAu7Fe ⁻⁷	0.0 to 300.0 K	±(0.15 % of rdg + 2.0 K)	±(0.2 % of rdg + 7.0 K)	0.1 K
	PLATINEL II ⁻⁷	0.0 to 1395.0 °C	±(0.25 % of rdg + 2.3°C)	±(0.25 % of rdg + 8.0°C)	0.1°C
	PR20-40 ⁻⁸	0.0 to 1900.0 °C	±(0.7 % of rdg + 0.4°C) However, accuracy at less than 800.0°C is not guaranteed.	±20.0°C However, accuracy at less than 800.0°C is not guaranteed.	0.1°C
	NiNiMo ⁻⁷	0.0 to 1310.0 °C	±(0.25 % of rdg + 0.7°C)	±(0.5 % of rdg + 5.0°C)	0.1°C
	W/WRe26 ⁻⁹	0.0 to 2320.0 °C	±(0.2 % of rdg + 2.0°C) However, accuracy at less than 300.0°C is not guaranteed.	±(0.4 % of rdg + 12.0°C) However, accuracy at less than 300.0°C is not guaranteed.	0.1°C
	N(AWG14) ⁻¹⁰	0.0 to 1300.0 °C	±(0.2 % of rdg + 1.3°C)	±(0.5 % of rdg + 7.0°C)	0.1°C
	XK GOST ⁻¹¹	-200.0 to 600.0 °C	±(0.25 % of rdg + 0.8°C)	±(0.5 % of rdg + 4.0°C)	0.1°C
	RTD (Measured current: 1 mA)	Pt100 ⁻¹²	-200.0 to 850.0 °C	±(0.15 % of rdg + 0.3°C)	±(0.3 % of rdg + 1.5°C)
-150.00 to 150.00 °C					0.01°C
-200.00 to 550.00 °C -150.00 to 150.00 °C					0.1°C 0.01°C
Cu10 GE		-200.0 to 300.0 °C	±(0.2 % of rdg + 2.0°C)	±(0.4 % of rdg + 6.0°C)	0.1°C
Cu10 L&N		-200.0 to 300.0 °C	guaranteed range	guaranteed range	
Cu10 WEED		-200.0 to 300.0 °C	Cu10 GE: -70.0 to 170.0 °C	Cu10 GE: -70.0 to 170.0 °C	
Cu10 BAILEY		-200.0 to 300.0 °C	Cu10 L&N: -75.0 to 150.0 °C	Cu10 L&N: -75.0 to 150.0 °C	
Cu10 at 20°C α=0.00392		-200.0 to 300.0 °C	Cu10 WEED: -200.0 to 260.0 °C	Cu10 WEED: -200.0 to 260.0 °C	
Cu10 at 20°C α=0.00393		-200.0 to 300.0 °C	Other range: -200.0 to 300.0 °C	Other range: -200.0 to 300.0 °C	
Cu25 at 0°C α=0.00425		-200.0 to 300.0 °C	±(0.3 % of rdg + 0.8°C)	±(0.5 % of rdg + 3.0°C)	0.1°C
Cu53 at 0°C α=0.00426035		-50.0 to 150.0 °C	±(0.15 % of rdg + 0.8°C)	±(0.3 % of rdg + 4.0°C)	0.1°C
Cu100 at 0°C α=0.00425		-50.0 to 150.0 °C	±(0.2 % of rdg + 1.0°C)	±(0.4 % of rdg + 5.0°C)	0.1°C

Continued

Input Type	Range	Measurement range	Measurement accuracy (digital display)		Max. resolution of digital display
			A/D integration time: 16.7ms or more ²²	A/D integration time: 1.67ms ²³	
RTD (Measured current: 1 mA)	J263B ¹³	0.0 to 300.0 K	±1.0 K Less than 40.0 K: ±3.0 K ±(0.15 % of rdg + 0.4°C)	±3.0 K Less than 40.0 K: ±9.0 K ±(0.3 % of rdg + 2.0°C)	0.1 K
	Ni100 (SAMA)	-200.0 to 250.0°C			0.1°C
	Ni100 (DIN) ¹⁴	-60.0 to 180.0°C			0.1°C
	Ni120 ¹⁵	-70.0 to 200.0°C			0.1°C
	Pt25 ¹⁶	-200.0 to 550.0°C	±(0.15 % of rdg + 0.8°C)	±(0.3 % of rdg + 4.0°C)	0.1°C
	Pt50 ¹⁷	-200.0 to 550.0°C	±(0.3 % of rdg + 0.6°C)	±(0.6 % of rdg + 3.0°C)	0.1°C
	Pt200 WEED	-100.0 to 250.0°C	±(0.3 % of rdg + 1.0°C)		0.1°C
	Cu10 GOST ¹⁸	-200.0 to 200.0°C	±(0.2 % of rdg + 2.0°C)	±(0.4 % of rdg + 6.0°C)	0.1°C
	Cu50 GOST ¹⁹	-200.0 to 200.0°C	±(0.15 % of rdg + 0.6°C)	±(0.3 % of rdg + 4.0°C)	0.1°C
	Cu100 GOST ²⁰	-200.0 to 200.0°C	±(0.15 % of rdg + 0.3°C)	±(0.3 % of rdg + 1.5°C)	0.1°C
	Pt46 GOST ¹⁹	-200.0 to 550.0°C	±(0.3 % of rdg + 0.8°C)	±(0.6 % of rdg + 4.0°C)	0.1°C
	Pt100 GOST ²⁰	-200.0 to 600.0°C	±(0.15 % of rdg + 0.3°C)	±(0.3 % of rdg + 2.0°C)	0.1°C
	4-wire RTD (Measured current: 1 mA)	Pt100 ¹²	-200.0 to 850.0°C	±(0.05 % of rdg + 0.3°C)	±(0.1 % of rdg + 1.5°C)
JPt100 ¹²		-150.00 to 150.00°C			0.01°C
Cu10 GE		-200.0 to 300.0°C	±(0.1 % of rdg + 2.0°C)	±(0.2 % of rdg + 5.0°C)	0.1°C
Cu10 L&N		-200.0 to 300.0°C	guaranteed range	guaranteed range	0.1°C
Cu10 WEED		-200.0 to 300.0°C	Cu10 GE: -70.0 to 170.0°C	Cu10 GE: -70.0 to 170.0°C	0.1°C
Cu10 BAILEY		-200.0 to 300.0°C	Cu10 L&N: -75.0 to 150.0°C	Cu10 L&N: -75.0 to 150.0°C	0.1°C
Cu10 at 20°C α = 0.00392		-200.0 to 300.0°C	Cu10 WEED: -200.0 to 260.0°C	Cu10 WEED: -200.0 to 260.0°C	0.1°C
Cu10 at 20°C α = 0.00393		-200.0 to 300.0°C	Other range: -200.0 to 300.0°C	Other range: -200.0 to 300.0°C	0.1°C
Cu25 at 0°C α = 0.00425		-200.0 to 300.0°C	±(0.1 % of rdg + 0.8°C)	±(0.2 % of rdg + 2.0°C)	0.1°C
Cu53 at 0°C α = 0.00426035		-50.0 to 150.0°C	±(0.05 % of rdg + 0.6°C)	±(0.1 % of rdg + 1.5°C)	0.1°C
Cu100 at 0°C α = 0.00425		-50.0 to 150.0°C	±(0.05 % of rdg + 0.3°C)	±(0.1 % of rdg + 1.5°C)	0.1°C
J263B ¹³		0.0 to 300.0K	±0.4 K Less than 40.0 K: ±0.8 K ±(0.05 % of rdg + 0.3°C)	±1.5 K Less than 40.0 K: ±3.0 K ±(0.1 % of rdg + 1.5°C)	0.1K
Ni100 (SAMA)		-200.0 to 250.0°C			0.1°C
Ni100 (DIN) ¹⁴		-60.0 to 180.0°C			0.1°C
Ni120 ¹⁵		-70.0 to 200.0°C			0.1°C
Pt25 ¹⁶		-200.0 to 550.0°C	±(0.1 % of rdg + 0.8°C)	±(0.2 % of rdg + 2.0°C)	0.1°C
Pt50 ¹⁷		-200.0 to 550.0°C	±(0.05 % of rdg + 0.6°C)	±(0.1 % of rdg + 1.5°C)	0.1°C
Pt200 WEED		-100.0 to 250.0°C	±(0.05 % of rdg + 1.0°C)	±(0.1 % of rdg + 3.0°C)	0.1°C
Cu10 GOST ¹⁸		-200.0 to 200.0°C	±(0.1 % of rdg + 2.0°C)	±(0.2 % of rdg + 5.0°C)	0.1°C
Cu50 GOST ¹⁹		-200.0 to 200.0°C	±(0.05 % of rdg + 0.6°C)	±(0.1 % of rdg + 1.5°C)	0.1°C
Cu100 GOST ²⁰		-200.0 to 200.0°C	±(0.05 % of rdg + 0.3°C)	±(0.1 % of rdg + 1.5°C)	0.1°C
Pt46 GOST ¹⁹		-200.0 to 550.0°C	±(0.05 % of rdg + 0.6°C)	±(0.1 % of rdg + 1.5°C)	0.1°C
Pt100 GOST ²⁰		-200.0 to 600.0°C	±(0.05 % of rdg + 0.3°C)	±(0.1 % of rdg + 1.5°C)	0.1°C
4-wire RTD (Measured current: 0.25 mA)	Pt500	-200.0 to 850.0°C	±(0.05 % of rdg + 0.3°C)	±(0.1 % of rdg + 1.5°C)	0.1°C
	Pt1000	-200.0 to 850.0°C			0.1°C
Resistance (4-wire)	20 Ω (Measured current: 1 mA)	0.0 to 20.000 Ω	±(0.05 % of rdg + 0.007Ω)	±(0.1 % of rdg + 0.025Ω)	0.001Ω
	200 Ω (Measured current: 1 mA)	0.0 to 200.00 Ω	±(0.05 % of rdg + 0.03Ω)	±(0.1 % of rdg + 0.15Ω)	0.01Ω
	2000 Ω (Measured current: 0.25 mA)	0.0 to 2000.0 Ω	±(0.05 % of rdg + 0.3Ω)	±(0.1 % of rdg + 1.0Ω)	0.1Ω
DI	Level		Threshold level (V _{th} =2.4 V) Accuracy: ±0.1 V		-
	Contact ²¹		Less than 1 kΩ: 1(ON), More than 100 kΩ: 0(OFF) (parallel capacitance of 0.01 μF or less)		-

rdg: Reading value

High-speed universal type

Input Type	Range	Measurement range	Measurement accuracy (digital display)		Max. resolution of digital display
			Scan interval: 50 ms or more (Only the Values in [] apply when the scan interval is 50/100/200 ms)	Scan interval: 20 ms or less (Only the Values in [] apply when the scan interval is 1/2/5 ms)	
DCV	20 mV	-20.000 to 20.000 mV	$\pm(0.05\% \text{ of rdg} + 5 [12] \mu\text{V})$	$\pm(0.1\% \text{ of rdg} + 25 [40] \mu\text{V})$	1 μV
	60 mV	-60.00 to 60.00 mV	$\pm(0.05\% \text{ of rdg} + 0.02 \text{ mV})$	$\pm(0.1\% \text{ of rdg} + 0.1 \text{ mV})$	10 μV
	200 mV	-200.00 to 200.00 mV	$\pm(0.05\% \text{ of rdg} + 0.02 [0.03] \text{ mV})$	$\pm(0.1\% \text{ of rdg} + 0.1 [0.4] \text{ mV})$	10 μV
	1 V	-1.0000 to 1.0000 V	$\pm(0.05\% \text{ of rdg} + 0.2 \text{ mV})$	$\pm(0.1\% \text{ of rdg} + 1.0 \text{ mV})$	100 μV
	2 V	-2.0000 to 2.0000 V	$\pm(0.05\% \text{ of rdg} + 0.5 [1.2] \text{ mV})$	$\pm(0.1\% \text{ of rdg} + 1.0 [4.0] \text{ mV})$	100 μV
	6 V	-6.000 to 6.000 V	$\pm(0.05\% \text{ of rdg} + 2 \text{ mV})$	$\pm(0.1\% \text{ of rdg} + 10 \text{ mV})$	1 mV
	20 V	-20.000 to 20.000 V	$\pm(0.05\% \text{ of rdg} + 2 [3] \text{ mV})$	$\pm(0.1\% \text{ of rdg} + 10 [40] \text{ mV})$	1 mV
	50 V	-50.00 to 50.00 V	$\pm(0.05\% \text{ of rdg} + 0.02 \text{ V})$	$\pm(0.1\% \text{ of rdg} + 0.10 \text{ V})$	10 mV
	100 V	-100.00 to 100.00 V	$\pm(0.05\% \text{ of rdg} + 0.02 \text{ V})$	$\pm(0.1\% \text{ of rdg} + 0.10 \text{ V})$	10 mV
Standard signal	0.4-2 V	0.3200 to 2.0800 V	$\pm(0.05\% \text{ of rdg} + 0.5 [1.2] \text{ mV})$	$\pm(0.1\% \text{ of rdg} + 1.0 [4.0] \text{ mV})$	100 μV
	1-5 V	0.800 to 5.200 V	$\pm(0.05\% \text{ of rdg} + 2 \text{ mV})$	$\pm(0.1\% \text{ of rdg} + 10 \text{ mV})$	1 mV
TC (Excluding RJC accuracy)	R ⁻³	0.0 to 1760.0 °C	$\pm(0.05\% \text{ of rdg} + 1.0^\circ\text{C})$	$\pm(0.1\% \text{ of rdg} + 4.0 [6.0]^\circ\text{C})$	0.1 °C
	S ⁻³	0.0 to 1760.0 °C	However, R, S; 0.0 to 800.0°C: $\pm 1.4^\circ\text{C}$, B; 400.0 to 800.0°C: $\pm 1.5 [3.0]^\circ\text{C}$	However, R, S; 0.0 to 800.0°C: $\pm 4.8 [7.6]^\circ\text{C}$, B; 400.0 to 800.0°C: $\pm 7.0 [11.0]^\circ\text{C}$	
	B ⁻³	0.0 to 1820.0 °C	Accuracy at less than 400.0°C is not guaranteed.	Accuracy at less than 400.0°C is not guaranteed.	
	K ⁻³	-270.0 to 1370.0 °C	$\pm(0.05\% \text{ of rdg} + 0.7^\circ\text{C})$	$\pm(0.1\% \text{ of rdg} + 3.5^\circ\text{C})$	0.1 °C
		-200.0 to 500.0 °C	However, -200.0 to 0.0°C: $\pm(0.2\% \text{ of rdg} + 0.7^\circ\text{C})$ Accuracy at less than -200.0°C is not guaranteed	However, -200.0 to 0.0°C: $\pm(2\% \text{ of rdg} + 3.5^\circ\text{C})$ Accuracy at less than -200.0°C is not guaranteed	
	E ⁻³	-270.0 to 800.0 °C	$\pm(0.05\% \text{ of rdg} + 0.5^\circ\text{C})$	$\pm(0.1\% \text{ of rdg} + 2.5^\circ\text{C})$	0.1 °C
	J ⁻³	-200.0 to 1100.0 °C	However, -200.0 to 0.0°C: $\pm(0.2\% \text{ of rdg} + 0.5^\circ\text{C})$ Accuracy at less than -200.0°C is not guaranteed	However, -200.0 to 0.0°C: $\pm(2\% \text{ of rdg} + 2.5^\circ\text{C})$ Accuracy at less than -200.0°C is not guaranteed	
	T ⁻³	-270.0 to 400.0 °C	$\pm(0.05\% \text{ of rdg} + 0.5^\circ\text{C})$	$\pm(0.1\% \text{ of rdg} + 2.5^\circ\text{C})$	0.1 °C
			However, -200.0 to 0.0°C: $\pm(0.2\% \text{ of rdg} + 0.5^\circ\text{C})$ Accuracy at less than -200.0°C is not guaranteed	However, -200.0 to 0.0°C: $\pm(2\% \text{ of rdg} + 2.5^\circ\text{C})$ Accuracy at less than -200.0°C is not guaranteed	
	N ⁻³	-270.0 to 1300.0 °C	$\pm(0.05\% \text{ of rdg} + 0.7^\circ\text{C})$	$\pm(0.1\% \text{ of rdg} + 4.0^\circ\text{C})$	0.1 °C
			However, -200.0 to 0.0°C: $\pm(0.5\% \text{ of rdg} + 0.7^\circ\text{C})$ Accuracy at less than -200.0°C is not guaranteed	However, -200.0 to 0.0°C: $\pm(3.5\% \text{ of rdg} + 4.0^\circ\text{C})$ Accuracy at less than -200.0°C is not guaranteed	
	W ⁻⁴	0.0 to 2315.0 °C	$\pm(0.05\% \text{ of rdg} + 1.0^\circ\text{C})$	$\pm(0.1\% \text{ of rdg} + 7.0^\circ\text{C})$	0.1 °C
	L ⁻⁵	-200.0 to 900.0 °C	$\pm(0.05\% \text{ of rdg} + 0.5^\circ\text{C})$	However, more than 1000.0°C: $\pm(0.15\% \text{ of rdg})$	0.1 °C
			Less than 0.0°C: $\pm(0.25\% \text{ of rdg} + 0.5^\circ\text{C})$	Less than 1000.0°C: $\pm(0.8\% \text{ of rdg})$	
	U ⁻⁵	-200.0 to 400.0 °C	$\pm(0.05\% \text{ of rdg} + 0.5^\circ\text{C})$	$\pm(0.1\% \text{ of rdg} + 2.5^\circ\text{C})$	0.1 °C
	WRe3-25 ⁻⁶	0.0 to 2320.0 °C	$\pm(0.05\% \text{ of rdg} + 2.0^\circ\text{C})$	$\pm(0.1\% \text{ of rdg} + 8.0^\circ\text{C})$	0.1 °C
			More than 2000.0°C: $\pm(0.15\% \text{ of rdg})$	Less than 200.0°C: 12.0°C More than 2000.0°C: $\pm(0.1\% \text{ of rdg} + 13.0^\circ\text{C})$	
	KpvsAu7Fe ⁻⁷	0.0 to 300.0 K	$\pm(0.05\% \text{ of rdg} + 0.7 [2.0] \text{ K})$	$\pm(0.1\% \text{ of rdg} + 3.5 [7.0] \text{ K})$	0.1 K
	PLATINEL II ⁻⁷	0.0 to 1395.0 °C	$\pm(0.05\% \text{ of rdg} + 1.0^\circ\text{C})$	$\pm(0.1\% \text{ of rdg} + 4.0^\circ\text{C})$	0.1 °C
PR20-40 ⁻⁸	0.0 to 1900.0 °C	$\pm(0.05\% \text{ of rdg} + 2.5 [5.5]^\circ\text{C})$	$\pm(0.1\% \text{ of rdg} + 12.0 [18.0]^\circ\text{C})$	0.1 °C	
		However, accuracy at less than 800.0°C is not guaranteed.	However, accuracy at less than 800.0°C is not guaranteed.		
NiNiMo ⁻⁷	0.0 to 1310.0 °C	$\pm(0.05\% \text{ of rdg} + 0.7^\circ\text{C})$	$\pm(0.1\% \text{ of rdg} + 2.7^\circ\text{C})$	0.1 °C	
W/WRe26 ⁻⁹	0.0 to 2320.0 °C	$\pm(0.05\% \text{ of rdg} + 2.0^\circ\text{C})$	$\pm(0.1\% \text{ of rdg} + 10.0^\circ\text{C})$	0.1 °C	
		However, accuracy at less than 300.0°C is not guaranteed.	However, accuracy at less than 300.0°C is not guaranteed.		
N(AWG14) ⁻¹⁰	0.0 to 1300.0 °C	$\pm(0.05\% \text{ of rdg} + 0.7^\circ\text{C})$	$\pm(1.0\% \text{ of rdg} + 4.0^\circ\text{C})$	0.1 °C	
XK GOST ⁻¹¹	-200.0 to 600.0 °C	$\pm(0.05\% \text{ of rdg} + 0.5^\circ\text{C})$	$\pm(0.1\% \text{ of rdg} + 2.5^\circ\text{C})$	0.1 °C	
		Less than 0.0°C: $\pm(0.2\% \text{ of rdg} + 0.5^\circ\text{C})$	Less than 0.0°C: $\pm(1\% \text{ of rdg} + 2.5^\circ\text{C})$		

Continued

Input Type	Range	Measurement range	Measurement accuracy (digital display)		Max. resolution of digital display
			Scan interval: 50 ms or more (Only the Values in [] apply when the scan interval is 50/100/200 ms)	Scan interval: 20 ms or less (Only the Values in [] apply when the scan interval is 1/2/5 ms)	
RTD (Measured current: 1 mA)	Pt100 ^{*13}	-200.0 to 850.0°C	±(0.05 % of rdg + 0.3°C)	±(0.1 % of rdg + 1.5°C)	0.1°C
		-150.00 to 150.00°C			0.01°C
	JPt100 ^{*13}	-200.0 to 550.0°C	±(0.1 % of rdg + 0.8°C)	±(0.2 % of rdg + 2.0°C)	0.1°C
		-150.00 to 150.00°C			0.01°C
	Cu25 at 0°C α=0.00425	-200.0 to 300.0°C	±(0.05 % of rdg + 0.6°C)	±(0.1 % of rdg + 1.5°C)	0.1°C
	Cu53 at 0°C α=0.00426035	-50.0 to 150.0°C	±(0.05 % of rdg + 0.3°C)	±(0.1 % of rdg + 1.5°C)	0.1°C
	Cu100 at 0°C α=0.00425	-50.0 to 150.0°C	±(0.05 % of rdg + 0.3°C)	±(0.1 % of rdg + 1.5°C)	0.1°C
	J263B ^{*14}	0.0 to 300.0 K	±4.0 K Less than 40.0 K: ±0.8 K	±1.5 K Less than 40.0 K: ±3.0 K	0.1 K
	Ni100 (SAMA)	-200.0 to 250.0°C	±(0.05 % of rdg + 0.3°C)	±(0.1 % of rdg + 1.5°C)	0.1°C
	Ni100 (DIN) ^{*15}	-60.0 to 180.0°C	±(0.1 % of rdg + 0.8°C)	±(0.2 % of rdg + 2.0°C)	0.1°C
	Ni120 ^{*16}	-70.0 to 200.0°C			
	Pt25 ^{*17}	-200.0 to 550.0°C	±(0.05 % of rdg + 0.6°C)	±(0.1 % of rdg + 1.5°C)	0.1°C
	Pt50 ^{*18}	-200.0 to 550.0°C	±(0.05 % of rdg + 1.0°C)	±(0.1 % of rdg + 3.0°C)	0.1°C
	Pt200 WEED	-100.0 to 250.0°C	±(0.05 % of rdg + 0.6°C)	±(0.1 % of rdg + 1.5°C)	0.1°C
	Cu50 GOST ^{*20}	-200.0 to 200.0°C	±(0.05 % of rdg + 0.3°C)	±(0.1 % of rdg + 1.5°C)	0.1°C
	Cu100 GOST ^{*21}	-200.0 to 200.0°C	±(0.05 % of rdg + 0.6°C)	±(0.1 % of rdg + 1.5°C)	0.1°C
Pt46 GOST ^{*20}	-200.0 to 550.0°C	±(0.05 % of rdg + 0.3°C)	±(0.1 % of rdg + 1.5°C)	0.1°C	
Pt100 GOST ^{*21}	-200.0 to 600.0°C	±(0.1 % of rdg + 0.7 [2.0]°C)	±(0.2 % of rdg + 2.5 [5.0]°C)	0.1°C	
RTD (Measured current: 1.6 mA)	Cu10 GE	-200.0 to 300.0°C	guaranteed range	guaranteed range	0.1°C
	Cu10 L&N	-200.0 to 300.0°C	Cu10 GE: -70.0 to 170.0°C	Cu10 L&N: -75.0 to 150.0°C	
	Cu10 WEED	-200.0 to 300.0°C	Cu10 L&N: -75.0 to 150.0°C	Cu10 WEED: -200.0 to 260.0°C	
	Cu10 BAILEY	-200.0 to 300.0°C	Cu10 WEED: -200.0 to 260.0°C	Other range: -200.0 to 300.0°C	
	Cu10 at 20°C α=0.00392	-200.0 to 300.0°C	Other range: -200.0 to 300.0°C		
	Cu10 at 20°C α=0.00393	-200.0 to 300.0°C			
	Cu10 GOST ^{*19}	-200.0 to 200.0°C	±(0.1 % of rdg + 0.7 [2.0]°C)	±(0.2 % of rdg + 2.5 [5.0]°C)	
DI	Level		Threshold level (V _{th} =2.4 V) Accuracy: ±0.1 V	-	
	Contact ^{*22}		Less than 100 Ω: 1(ON), More than 10 kΩ: 0(OFF)	-	

rdg: Reading value

*3 R, S, B, K, E, J, T, N: IEC60584-1, DIN EN60584, JIS C1602, ASTM E230

*4 W: W-5%Re/W-26%Re(Hoskins Mfg.Co.) ASTM E988-96

(Type C equivalent of OMEGA Engineering Inc.)

*5 L: Fe-CuNi, DIN43710, U: Cu-CuNi, DIN43710

*6 WRe3-25: W-3%Re/W-25%Re(Hoskins Mfg.Co.) ASTM E988-96

(Type D equivalent of OMEGA Engineering Inc.)

*7 KpvsAu7Fe, PLATINEL II, NiNiMo: ASTM E1751

*8 PR20-40: PtRh20%-PtRh40%(Johnson Matthey Plc) ASTM E1751

*9 W/WRe26: W/W-26%Re(Hoskins Mfg.Co.) ASTM E1751

(Type G equivalent of OMEGA Engineering Inc.)

*10 N(AWG14): NBS

*11 XK GOST: Type L (GOST R 8.525-2001)

*12 Pt100: JIS C1604, IEC60751, DIN EN60751

JPt100: JIS C1604, JIS C1606

*13 J263B: Yokogawa Electric Corporation J263*B

*14 Ni100 (DIN): DIN 43760

*15 Ni120: McGRAW EDISON COMPANY

*16 Pt25: One-fourth of JPt100 resistance value

*17 Pt50: JIS C1604, JIS C1606

*18 Cu10 GOST: One-tenth of Cu100 GOST resistance value

*20 Cu50 GOST, Pt46 GOST: GOST 6651-94

*20 Cu100 GOST, Pt100 GOST: GOST 6651-2009

*21 The detected current value is approx. 10 μA.

*22 10 channel mode with scan interval set to 500 ms or higher, or 2 channel mode

*23 10 channel mode with scan interval set to 100 ms or 200 ms

Measurement accuracy at scaling: measurement accuracy at scaling (digits) = measurement accuracy (digits) × scaling span (digits)/measurement span (digits) + 1 digit

* Rounding up decimal places

- Burnout detection^{*1 *2}: Burnout upscale, downscale, or OFF selectable (for each channel).
 - Available input: TC, RTD, Standard signal
 - Detection condition; TC; Universal, Low withstand voltage relay, Electromagnetic relay, High withstand voltage type
 - Normal: 2 kΩ or less., Burnout: 200 kΩ or more (parallel capacitance of 0.01 μF or less)
 - Detection current: Approx. 10 μA
 - High-speed universal type
 - Detection current: Approx. 50 nA, Superposed electric current system
 - RTD; Universal type
 - Normal: wiring resistance or less, Burnout: 200 kΩ or more parallel capacitance of less than 0.01 μF or less
 - Detection current: Approx. 10 μA
 - High-speed universal type
 - Detection current: Approx. 100 nA, Superposed electric current system
 - Standard signal:
 - Normal: Within measuring range
 - Burnout: Depends on the setting of the burnout judgment value. The burnout judgment value shall be set with the percentage of the specified span width.
 - Lower limit: -20.0 to -5.0 %
 - Upper limit: 105 to 120 %
- *1 None for the 4-wire RTD/resistance type
- *2 If the scan interval on the high speed AI module is 1 to 20 ms, burnout detection will not work correctly.
- Input external resistance:
 - DC voltage, thermocouple input: 2 kΩ or below
 - Resistance temperature detector input: 10 Ω or below in each wire (Same resistance in three wires)
- Input bias current: ±10 nA or less (when burnout function does not work)
- Measured current (for RTD):
 - universal type: Approx. 1 mA
 - High-speed universal type: Approx. 1 mA/1.6 mA (depends on the range)
 - 4-wire RTD/resistance: Approx. 1 mA/0.25 mA (depends on the range)
- Input resistance:
 - 10 MΩ or more for TC/DC voltage (1 V range or less) input
 - Approx. 1 MΩ for DC voltage (2 V range or more)/standard signal input/DI voltage (High-speed universal type)/while measurement is stopped (High-speed universal type)
 - 250 Ω (249.5 Ω typ) for DC mA
 - * typ: Typical value (Typical)
- Allowable signal source resistance: 2 kΩ or less for TC/DC voltage (1 V range or less) input
- Effect of signal source resistance:
 - ±10 μV/1kΩ or less for TC/DC voltage (1 V range or less) input
 - ±0.15 % of rdg/1kΩ or less for DC voltage (2 V range or more)/standard signal input
- Allowable wiring resistance: Max. 10 Ω per line for RTD input (conductor resistance between the three lines shall be equal)
- Effect of wiring resistance: ±0.1°C/10 Ω for RTD input (conductor resistance between the three lines shall be equal), ±1°C/10 Ω (50Ω system or less, High-speed universal type)
 - 4-wire RTD/resistance type
 - 4-wire RTD100 Ω system or more: ±0.1°C/10 Ω
 - 4-wire RTD50 Ω system or less: ±1°C/10 Ω
 - Resistance 20 Ω: ± 0.001 Ω or less
 - Resistance 200 Ω: ± 0.01 Ω or less
 - Resistance 2000 Ω: ± 0.1 Ω or less
- Allowable input voltage:
 - Universal, Low withstand voltage relay, Electromagnetic relay, High withstand voltage type:
 - ±10 V DC for TC/DC voltage (1 V range or less)/RTD/DI (contact) input, DC mA
 - ±60 V DC for DC voltage (2 V range or more) input/DI (level) input
 - High-speed universal type:
 - ±120 V DC
- Allowable input current (current (mA) input type): 24 mA, 50/60 Hz, peak value including signal
- Noise reduction ratio
 - Universal, Low withstand voltage relay, current (mA) input, Electromagnetic relay, 4-wire RTD/resistance, High withstand voltage type:

Integration time *1	Normal mode	Common mode
1.67 ms	50/60 Hz, no noise reduction	More than 80 dB *2 *4
More than 16.67 ms	More than 40 dB *2 *3	More than 120 dB *2 *4

High-speed universal type:

Scan interval *1	Normal mode	Common mode
20 ms or less	50/60 Hz, no noise reduction	More than 80 dB *2 *4
More than 50 ms	More than 40 dB *2 *3	More than 120 dB *2 *4

*1 A frequency discrimination setting is made in the main unit.

*2 A resistance temperature detector range is a converted value of voltage when a measured current flows.

*3 50/60 Hz ± 0.1 %

*4 50/60 Hz ± 0.1%, 500 Ω imbalance, between minus measuring terminal and ground

- Normal mode voltage for TC/ DC voltage (1 V range or less)/DI (voltage): 1.2 times or less of rated range
 - Standard signal 0.4 to 2 V range: 2.4 V
 - Standard signal 1-5 V range: 6 V
 - RTD (100 Ω system or more) : 50 mV peak
 - RTD (50 Ω system or less) : 10 mV peak
 - * 50/60Hz, The peak value including the signal.
- 4-wire RTD/resistance
 - Resistance (2000 Ω), RTD (100 Ω, 500 Ω 1000 Ω system): 50 mV peak
 - Resistance (200 Ω), RTD (10 Ω, 25 Ω 50 Ω system): 10 mV peak
 - Resistance (20 Ω): 4 mV peak
- Normal mode current (current (mA) input type): 24 mA DC (Value converted to voltage: 6V)
 - * 50/60 Hz, The peak value including the signal.

- Common mode voltage for measuring input: 30 V ACrms (50/60Hz) or ± 60 V DC (Maximum common mode noise voltage for measuring input: 250 V ACrms)
High-speed universal type only
300 V ACrms (50/60Hz), Double insulation
High withstand voltage type only
600 V ACrms (50/60Hz) or 600 V DC, Double insulation
1000 V DC, Basic insulation*
* When the module is used under basic insulation conditions, external supplementary insulation is required for safe use. When the system is used in a common mode voltage environment that exceeds 600 V, to add supplementary insulation, you need to install the system in a panel, add an overcurrent protection device, and add an insulation device. Refer to the First Step Guide (IM 04L51B01-02EN, IM 04L55B01-02EN), and take the appropriate measures.
- Maximum voltage between measuring input channels: 30 V ACrms (50/60 Hz) or ± 60 V DC (Maximum common mode noise voltage between measuring input channels: 250 V ACrms (60 V ACrms for low-voltage relay type))
High-speed universal type
300 V ACrms (50/60Hz), Double insulation
- Reference junction compensation accuracy:
When measuring temperature greater than or equal to 0 °C and when Integral time 16.6 ms or more or scan interval 50 ms or more (for the high-speed universal type) and when input terminal temperature is balanced
Type K, E, J, T, N, XK GOST: ± 0.5 °C (23 °C \pm 2 °C), ± 0.7 °C (0 to 50 °C), ± 1.0 °C (-20 to 60 °C)
Type R, S, W, L, U, W97Re3-W75Re25, Platinel2, NiNiMo, W/WRe26, N(AWG14): ± 1.0 °C (23 °C \pm 2 °C), ± 1.4 °C (0 to 50 °C), ± 2.0 °C (-20 to 60 °C)
Type KpvsAu7Fe: ± 1.0 K (23 °C \pm 2 °C), ± 1.4 K (0 to 50 °C), ± 2.0 K (-20 to 60 °C)
Type B, PR20-40: Internal reference compensation is fixed to 0°C
- Scan interval/A/D integration time:
10 ch. mode, 6 ch mode³

Universal ¹, Current (mA) input ¹, 4-wire RTD/resistance, High withstand voltage ¹ type

Scan interval	Integration time
100 ms/200 ms	1.67 ms
500 ms or more	16.67 ms/20 ms
1 s	36.67 ms
2 s or more	100 ms

Electromagnetic relay scanner type

Scan interval	Integration time
1 s or more	16.67 ms/20 ms
2 s	36.67 ms
5 s	100 ms

Low withstand voltage relay type

Scan interval	Integration time
500 ms or more	16.67 ms/20 ms
2 s	36.67 ms
5 s	100 ms

2 ch. mode²

Scan interval	Integration time
100 ms or more	16.67 ms/20 ms
1 s	36.67 ms
2 s or more	100 ms

*1 In 10ch mode, when the scan interval is set to 100 ms or 200 ms, the A/D integration time is fixed at 1.67 ms. This prevents power frequency noise from being eliminated, causing measured values to wobble.

*2 Cannot be specified for the electromagnetic relay type, Low withstand voltage relay type, High-speed universal type.

*3 For the 4-wire RTD/resistance type.

- Scan interval/filter type:
High-speed universal type

Scan interval	Filter
20 ms or less	Non*
50 ms/100 ms/200 ms	50 Hz/60 Hz Simultaneous removal of 50 Hz and 60 Hz
500 ms or more	50 Hz/60 Hz/10 Hz

* With the high-speed universal type, when the scan interval is 20 ms or less, supply frequency noise is not removed. As such, the measured values may fluctuate especially in temperature measurement using thermocouples.

- Calibration correction:
Mode: Linearizer Approximation, Linearizer Bias
Number of correcting points: 12
- Moving average function:
Can be switched On/Off (Settable for each channel)
Moving average number can be selected from 2 to 100 times
Select from 2 to 500 for the high-speed universal type.
- First-order lag input filter (high-speed universal type): Can be turned on/off for each channel
Time constant: Scan interval \times N where N is between 3 and 300)
- Reference junction compensation:
Mode: Can be switch internal or external (Settable for each channel)
(Set the value of the compensation temperature at external)
- Input calculation:
Linear scaling, square root*, differential calculations (Settable for each channel)
- * Not available for the 4-wire RTD/resistance type
- Bias function:
Can be set the bias value to be added to the input value (Settable for each channel)
- Terminal type: M3 screw terminal or Clamp terminal
- Withstand voltage
Universal, Electromagnetic relay, 4-wire RTD/resistance type;
Between the input terminals and the internal circuit: 3000 V AC for one minute
Between the analog input channels: 1000VAC for one minute (excluding b-terminal)
Current (mA) input type;
Between the input terminals and the internal circuit: 1500 V AC for one minute
Between the analog input channels: 1000 V AC for one minute (excluding b-terminal)

- Low withstand voltage type;
Between the input terminals and the internal circuit: 1500 V AC for one minute
Between the analog input channels: 400 V AC for one minute (excluding b-terminal)
- High-speed universal type;
Between the input terminals and the internal circuit: 3000 V AC for one minute
Between the analog input channels: 3000 V AC for one minute
- High withstand voltage
Between the input terminals and the internal circuit: 3700 V AC for one minute
Between the analog input channels: 1000 V AC for one minute
- Insulation resistance:
Between the input terminals and the internal circuit: 20 M Ω or greater at 500 V DC
Between the analog input channels*: 20 M Ω or greater at 500 V DC
 - * Excludes the b terminal of the universal type
 - Recommended replacement period of electromagnetic relay scanner type modules:
Electromagnetic relay scanner type modules make measurements by switching mechanical contact relays on and off.
To ensure that the modules continue to operate reliably and correctly, replace them
Continuous use at measurement interval 1 s: 1 year
Continuous use at measurement interval 2 s: 2 years
Continuous use at measurement interval 5 s: 5 years

Safety and EMC Standards

- CSA:
CSA C22.2 No. 61010-1,
CSA-C22.2 No. 61010-2-030,
Overvoltage Category II or I^{*1}, Pollution Degree 2^{*2},
Measurement Category II^{*4}
 - UL:
UL 61010-1, UL Std. No. 61010-2-030 (CSA NRTL/C), Overvoltage Category II or I^{*1}, Pollution Degree 2^{*2}, Measurement Category II^{*4}
 - CE, UKCA/EMC directive^{*3}:
EN 61326-1 Class A Table 2 (For use in industrial locations) compliant
EN 61000-3-2 compliant
EN IEC 61000-3-2 compliant
EN 61000-3-3 compliant
EN 55011 Class A Group 1 compliant
 - CE, UKCA/Low voltage directive^{*3}:
EN 61010-1, EN IEC 61010-2-030 compliant,
Overvoltage Category II or I^{*1}, Pollution Degree 2^{*2},
Measurement Category II^{*4}
 - CE, UKCA/EU RoHS directive^{*3}: EN IEC 63000
 - WEEE directive: Compliant
 - EMC Regulatory Arrangement in Australia and New Zealand (RCM): EN 55011 Class A Group 1 compliant
 - KC marking: KS C9811, KS C9610-6-2 compliant
- *1 Overvoltage Category: Describes a number which defines a transient overvoltage condition. Implies the regulation for impulse withstand voltage.
Applies to electrical equipment which is supplied from the fixed installation like a distribution board.
II or I depends on the power supply specification of the main unit.

- *2 Pollution Degree 2:
Describes the degree to which a solid, liquid, or gas which deteriorates dielectric strength or surface resistivity is adhering.
"2" applies to normal indoor atmosphere.
Normally, only non-conductive pollution occurs.
- *3 The CE, UKCA standards for modules represent standards that are met when the module is installed in the main unit.
- *4 Measurement Category II (CAT II):
Applies to measuring circuits connected to low voltage installation, and electrical instruments supplied with power from fixed equipment such as electric switchboards.

Construction

- Front panel (terminal): Water and dust-proof, Complies with IEC529-IP20
- Material: Polycarbonate
- Color;
Front: Charcoal grey light (Munsell 10B3.6/0.3 equivalent)
Bezel: Smoke blue (Munsell 4.1PB6.0/4.5 equivalent)
- Dimensions: 45.2 mm(W) x 111 mm(H) x 133.1 mm(D) (D: including terminal cover)
- Weight: Approx. 0.3 kg

Power Supply

Supply from GX/GP, GX60 expandable I/O, GM90PS power supply module.

- Power consumption:
GX90XA-10-U2: 0.7 W or less
GX90XA-10-T1: 0.9 W or less
GX90XA-10-C1: 0.7 W or less
GX90XA-10-L1: 0.7 W or less
GX90XA-04-H0: 2.0 W or less
GX90XA-06-R1: 0.7 W or less
GX90XA-10-V1: 1.0 W or less

Isolation

Universal, Low withstand voltage relay,
Electromagnetic relay, Current (mA) input type

Analog input CH1	Input circuit	Internal circuit
Analog input CH2		
Analog input CH3		
Analog input CH4		
Analog input CH5		
Analog input CH6		
Analog input CH7		
Analog input CH8		
Analog input CH9		
Analog input CH10		

———— Functional insulation

===== Reinforced insulation

High withstand voltage type

Analog input CH1	Input circuit	Internal circuit
Analog input CH2		
Analog input CH3		
Analog input CH4		
Analog input CH5		
Analog input CH6		
Analog input CH7		
Analog input CH8		
Analog input CH9		
Analog input CH10		

———— Functional insulation

===== Double insulation (600 V ACrms 50/60 Hz,
600 V DC) or Basic insulation (1000 V DC)

High-speed universal type

Analog input CH1	Internal circuit
Analog input CH2	
Analog input CH3	
Analog input CH4	

===== Double insulation (300 Vrms 50/60Hz)

4-wire RTD/resistance type

Analog input CH1	Input circuit	Internal circuit
Analog input CH2		
Analog input CH3		
Analog input CH4		
Analog input CH5		
Analog input CH6		

———— Functional insulation

===== Reinforced insulation

Terminal arrangements

M3 screw terminal

Universal, Low withstand voltage relay,
Electromagnetic relay, Current (mA) input, High
withstand voltage type

No.	Symbol	No.	Symbol	No.	Symbol
301	CH1(/b)*1	201	CH1(-/B)	101	CH1(+/A)
302	CH2(/b)*1	202	CH2(-/B)	102	CH2(+/A)
303	CH3(/b)*1	203	CH3(-/B)	103	CH3(+/A)
304	CH4(/b)*1	204	CH4(-/B)	104	CH4(+/A)
305	CH5(/b)*1	205	CH5(-/B)	105	CH5(+/A)
306	CH6(/b)*1	206	CH6(-/B)	106	CH6(+/A)
307	CH7(/b)*1	207	CH7(-/B)	107	CH7(+/A)
308	CH8(/b)*1	208	CH8(-/B)	108	CH8(+/A)
309	CH9(/b)*1	209	CH9(-/B)	109	CH9(+/A)
310	CH10(/b)*1	210	CH10(-/B)	110	CH10(+/A)

*1 There are no symbol indications for the
electromagnetic relay type, current (mA) input
type, low withstand voltage relay type, or high
withstand voltage type.

* RTD input terminal b is shorted internally across
all channels.

High-speed universal type

No.	Symbol	No.	Symbol	No.	Symbol
301	CH1(/A)	201	CH1(-/b)	101	CH1(+/B)
304	CH2(/A)	204	CH2(-/b)	104	CH2(+/B)
307	CH3(/A)	207	CH3(-/b)	107	CH3(+/B)
310	CH4(/A)	210	CH4(-/b)	110	CH4(+/B)

4 wire RTD/resistance type

No.	Symbol	No.	Symbol	No.	Symbol
301	CH1(B)	201	CH1(A)	101	CH1(I)
302	CH1(C)	202	Not Used	102	CH2(C)
303	CH2(B)	203	CH2(A)	103	CH2(I)
304	CH3(B)	204	CH3(A)	104	CH3(I)
305	CH3(C)	205	Not Used	105	CH4(C)
306	CH4(B)	206	CH4(A)	106	CH4(I)
307	CH5(B)	207	CH5(A)	107	CH5(I)
308	CH5(C)	208	Not Used	108	CH6(C)
309	CH6(B)	209	CH6(A)	109	CH6(I)
310	Not Used	210	Not Used	110	Not Used

Clamp terminal

Universal, Low withstand voltage relay,
Electromagnetic relay, Current (mA) input type, High
withstand voltage type

No.	Symbol	No.	Symbol
201	CH2(+/A)	101	CH1(+/A)
202	CH2(-/B)	102	CH1(-/B)
203	CH2(/b) *1	103	CH1(/b) *1
204	CH4(+/A)	104	CH3(+/A)
205	CH4(-/B)	105	CH3(-/B)
206	CH4(/b) *1	106	CH3(/b) *1
207	CH6(+/A)	107	CH5(+/A)
208	CH6(-/B)	108	CH5(-/B)
209	CH6(/b) *1	109	CH5(/b) *1
210	CH8(+/A)	110	CH7(+/A)
211	CH8(-/B)	111	CH7(-/B)
212	CH8(/b) *1	112	CH7(/b) *1
213	CH10(+/A)	113	CH9(+/A)
214	CH10(-/B)	114	CH9(-/B)
215	CH10(/b) *1	115	CH9(/b) *1

*1 There are no symbol indications for the electromagnetic relay type, current (mA) input type, low withstand voltage relay type, or high withstand voltage type.

* RTD input terminal b is shorted internally across all channels.

4-wire RTD/resistance

No.	Symbol	No.	Symbol
201	CH2(I)	101	CH1(I)
202	CH2(A)	102	CH1(A)
203	CH2(B)	103	CH1(B)
204	CH2(C)	104	CH1(C)
205	Not Used	105	Not Used
206	CH4(I)	106	CH3(I)
207	CH4(A)	107	CH3(A)
208	CH4(B)	108	CH3(B)
209	CH4(C)	109	CH3(C)
210	Not Used	110	Not Used
211	CH6(I)	111	CH5(I)
212	CH6(A)	112	CH5(A)
213	CH6(B)	113	CH5(B)
214	CH6(C)	114	CH5(C)
215	Not Used	115	Not Used

A/D Calibration Value

Two types of A/D calibration values (factory shipment setting and user setting) can be saved. If the user setting is not proper, it can be restored to the calibration value at factory shipment.

High-speed universal type

No.	Symbol	No.	Symbol
201	CH1(+/B)	101	Not Used
202	CH1(-/b)	102	Not Used
203	CH1(/A)	103	Not Used
204	Not Used	104	Not Used
205	CH2(+/B)	105	Not Used
206	CH2(-/b)	106	Not Used
207	CH2(/A)	107	Not Used
208	Not Used	108	Not Used
209	CH3(+/B)	109	Not Used
210	CH3(-/b)	110	Not Used
211	CH3(/A)	111	Not Used
212	Not Used	112	Not Used
213	CH4(+/B)	113	Not Used
214	CH4(-/b)	114	Not Used
215	CH4(/A)	115	Not Used

External Dimensions

- Except high speed universal type and high withstand voltage type

M3 screw terminal

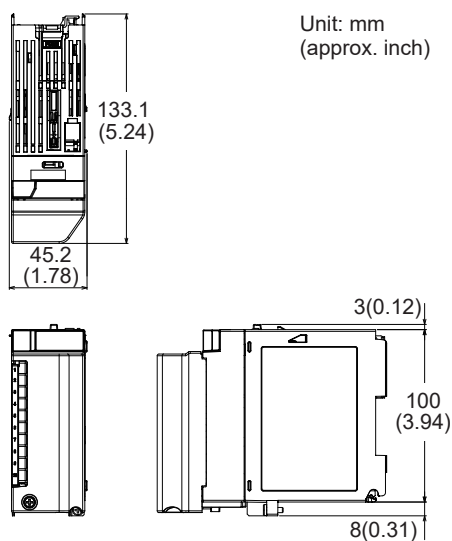

Clamp terminal

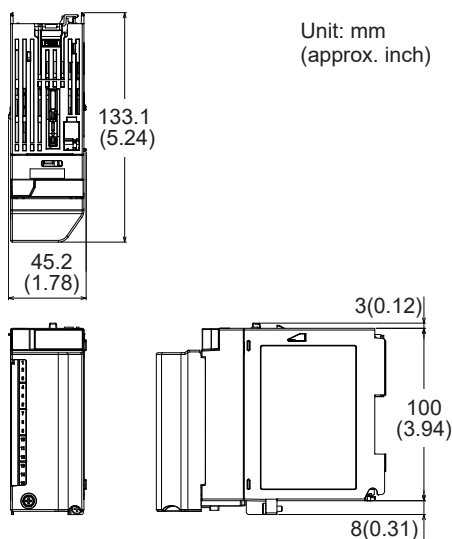

- High speed universal type and high withstand voltage type

M3 screw terminal

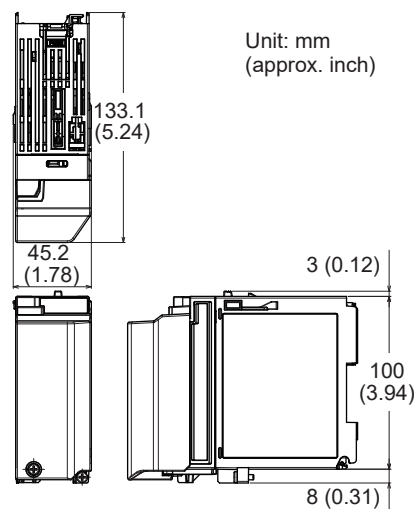

Clamp terminal

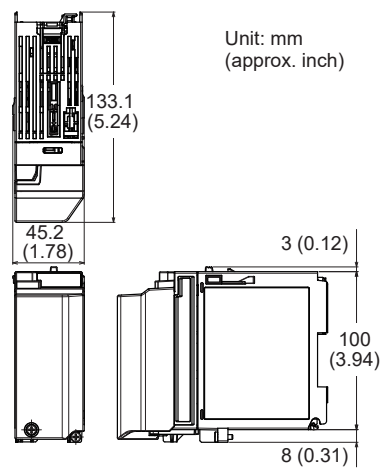

Normal Operating Conditions

For normal operating conditions of this module, please refer to the General Specifications of the device (GX/GP, I/O Base Unit, or GM) that this module is mounted.

GX Specifications: GS 04L51B01-01EN

GP Specifications: GS 04L52B01-01EN

I/O Base Unit (Expandable I/O) Specifications: GS 04L53B00-01EN

GM Specifications: GS 04L55B01-01EN

Transport and Storage Conditions

- Ambient temperature: -25 to 70°C
- Ambient humidity: 5 to 95 %RH (no condensation)
- Vibration: 10 to 60 Hz, 4.9 m/s^2 maximum
- Shock: 392 m/s^2 maximum (in packaged condition)

Effects of Operating Conditions

Integral time 16.67 ms or more or scan interval 50 ms or more (for the high-speed universal type)

- Influence of ambient temperature: variation against a change of 10°C at an accumulation time of 16.67 ms or more \pm (0.05% of rdg + 0.05% of range) or below.
(In case of current (mA) input type, \pm (0.075% of rdg + 0.05% of range) or below.)
KpvsAu7Fe, PR20-40: \pm (0.05% of rdg + 0.1% of range) or below, Cu10 Ω system or less: \pm (0.2% of rdg + 0.1°C) or below
No reference contact accuracy is guaranteed.
- Influence of power supply voltage variation: Accuracy is satisfied in the range of rated power supply voltage.
- Influence of external magnetic field: Variations against an AC external magnetic field (50/60 Hz, 400 A/m) are \pm (0.1% of rdg+ 0.1% of range) or below.

Installation limitations

If you want to use the electromagnetic relay type or high-speed universal type modules on a GM10 single unit, up to eight modules can be installed.

DIGITAL INPUT MODULE (Model GX90XD or GX/GP main unit options /CRx1)



GX90XD

- Application: Remote control input, pulse input^{*1}, etc
- Number of inputs: 16
- input type: DI, pulse^{*1}
- Measurement interval: 100 ms (shortest)
- Input type: Open collector or Voltage-free contact
- Insulation type: Photocoupler, Trance (power supply)
- Contact rating: 12 V DC, 20 mA or more
- Input resistance: Approx. 1 k Ω
- Allowable input voltage: +10 V
- ON/OFF detection
 - Open collector contact input:
 - Voltage in ON state: 0.5 V DC or less
 - Leakage current in OFF state: 0.5 mA or less
 - Voltage-free contact input:
 - Contact resistance in ON state: 200 Ω or less
 - Contact resistance in OFF state: 50 k Ω or more
- Number of common: 2 (1 point/8 channels)
- Terminal type: M3 screw terminal or Clamp terminal
(In case of Options /CRx1, a digital input module has M3 screw terminals.)
- Withstand voltage
Between the input terminals and the internal circuit: 1500 V AC for one minute
- Insulation resistance:
Between the input terminals and the internal circuit: 20 M Ω or greater at 500 VDC
[Pulse input specifications]^{*1}
- Counting system: The rising edge of the pulse is counted.
 - Open collector: The signal level at the input terminal changes from high to low.
 - Voltage-free contact: The contact changes from open to close.
- Max. pulse period:
 - 250Hz (The chattering filter: Off)
 - 125Hz (The chattering filter: On)
- Min. detection pulse width: Low (close), High (open), both is 2 ms or more
- Pulse detection period: 1 ms
- Pulse measuring accuracy: ± 1 pulse
- Pulse count interval: measurement interval
- Filter: The chattering filter can be switched On/Off^{*}.

^{*} When the chattering filter is off, connect GX/GP/GM so that it is not affected by the noise.

^{*1} MATH function (optional code /MT) is required.

Safety and EMC Standards

- CSA:
 - CSA C22.2 No. 61010-1, Overvoltage Category II or I^{*1}, Pollution Degree 2^{*2}
- UL:
 - UL 61010-1 (CSA NRTL/C), Overvoltage Category II or I^{*1}, Pollution Degree 2^{*2}
- CE, UKCA/EMC directive^{*3}:
 - EN 61326-1 Class A Table 2 (For use in industrial location) compliant
 - EN 61000-3-2 compliant
 - EN IEC 61000-3-2 compliant
 - EN 61000-3-3 compliant
 - EN 55011 Class A Group 1 compliant
- CE, UKCA/Low voltage directive^{*3}:
 - EN 61010-1 compliant, Overvoltage Category II or I^{*1}, Pollution Degree 2^{*2}
- CE, UKCA/EU RoHS directive^{*3}: EN IEC 63000
- WEEE Directive: Compliant
- EMC Regulatory Arrangement in Australia and New Zealand (RCM): EN 55011 Class A Group 1 compliant
- KC marking: KS C9811, KS C9610-6-2 compliant

^{*1} Overvoltage Category: Describes a number which defines a transient overvoltage condition. Implies the regulation for impulse withstand voltage. Applies to electrical equipment which is supplied from the fixed installation like a distribution board. II or I depends on the power supply specification of the main unit.

^{*2} Pollution Degree 2: Describes the degree to which a solid, liquid, or gas which deteriorates dielectric strength or surface resistivity is adhering. "2" applies to normal indoor atmosphere. Normally, only non-conductive pollution occurs.

^{*3} The CE, UKCA standards for modules represent standards that are met when the module is installed in the main unit.

Construction

- Front panel (terminal): Water and dust-proof, Complies with IEC529-IP20
- Material: Polycarbonate
- Color;
 - Front: Charcoal grey light (Munsell 10B3.6/0.3 equivalent)
 - Bezel: Smoke blue (Munsell 4.1PB6.0/4.5 equivalent)
- Dimensions: 45.2 mm(W) x 111 mm(H) x 133.1 mm(D) (D: including terminal cover)
- Weight: Approx. 0.3 kg

Power Supply

Supply from GX/GP, GX60 expandable I/O, GM90PS power supply module.

- Power consumption: 0.7 W or less

Isolation

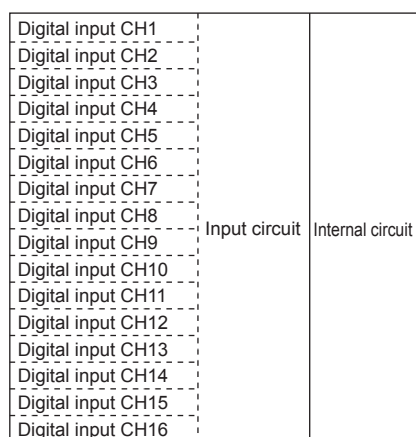

———— Functional insulation

- - - - - Non-isolated

Terminal arrangements

M3 screw terminal/Clamp terminal

No.	Symbol	No.	Symbol
21	DI9	11	DI1
22	DI10	12	DI2
23	DI11	13	DI3
24	DI12	14	DI4
25	DI13	15	DI5
26	DI14	16	DI6
27	DI15	17	DI7
28	DI16	18	DI8
29	COM2	19	COM1
30	-	20	-

External Dimensions

M3 screw terminal

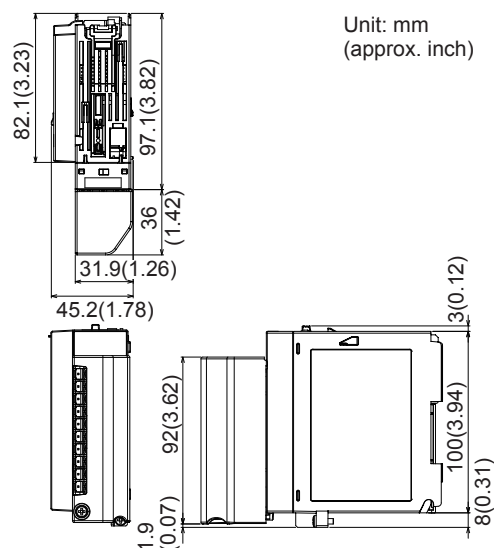

Clamp terminal

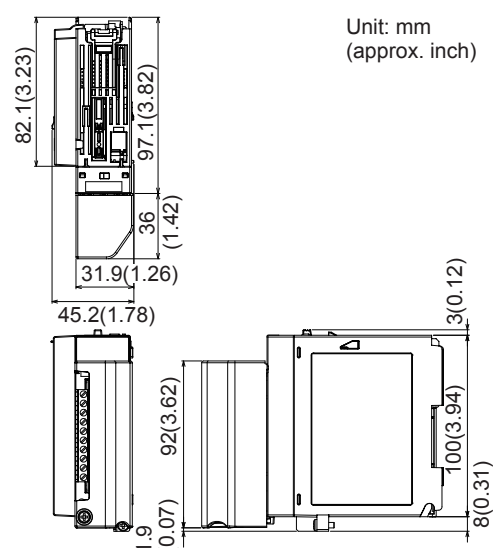

Normal Operating Conditions

For normal operating conditions of this module, please refer to the General Specifications of the device (GX/GP, I/O Base Unit, or GM) that this module is mounted.

GX Specifications: GS 04L51B01-01EN

GP Specifications: GS 04L52B01-01EN

I/O Base Unit (Expandable I/O): GS 04L53B00-01EN

GM Specifications: GS 04L55B01-01EN

Transport and Storage Conditions

Same as the GX90XA.

Installation limitations

When the measurement mode is High speed, a single module, either this module or the GX90WD, can be installed. DI input is fixed to remote mode. Measurement and recording are not possible.

DIGITAL OUTPUT MODULE (Model GX90YD, or GX/GP main unit options /CR1x, /CR2x, /CR4x)



GX90YD

- Application: Alarm output, etc
- Number of outputs: 6
- Output update interval: 100 ms (shortest)
- Output type: Relay contact output, SPDT (NO-C-NC)
- Insulation type: Mechanical
- Rated load voltage: 30 V DC or 250 V AC or less
- Max. load current: 3 A (DC)/3 A (AC), resistance load, each channel
- Min. load voltage/current: 5 V DC/10mA
- Recommended replacement periods of contact: Mechanical 5,000,000 more ON-OFF operations
Electrical 30,000 more ON-OFF operations (250 V AC 3 A or 30 V DC 3 A, resistance load)
- Number of common: 6
- Terminal type: M3 screw terminal
- Withstand voltage
Between the output terminals and the internal circuit: 3000 V AC for one minute
Between the output terminals: 3000 V AC for one minute
- Insulation resistance:
Between the output terminals and the internal circuit: 20 MΩ or greater at 500 VDC
Between the output terminals: 20 MΩ or greater at 500 VDC

Safety and EMC Standards

- CSA:
CSA C22.2 No. 61010-1,
Overvoltage Category II or I¹, Pollution Degree 2²
- UL:
UL 61010-1(CSA NRTL/C),
Overvoltage Category II or I¹, Pollution Degree 2²
- CE, UKCA/EMC directive³:
EN 61326-1 Class A Table 2(For use in industrial locations) compliant
EN 61000-3-2 compliant
EN IEC 61000-3-2 compliant
EN 61000-3-3 compliant
EN 55011 Class A Group 1 compliant
- CE, UKCA/Low voltage directive³:
EN 61010-1 compliant,
Overvoltage Category II or I¹, Pollution Degree 2²
- CE, UKCA/EU RoHS directive³: EN IEC 63000
- WEEE Directive: Compliant
- EMC Regulatory Arrangement in Australia and New Zealand (RCM): EN 55011 Class A Group 1 compliant
- KC marking: KS C9811, KS C9610-6-2 compliant

- *1 Overvoltage Category: Describes a number which defines a transient overvoltage condition. Implies the regulation for impulse withstand voltage. Applies to electrical equipment which is supplied from the fixed installation like a distribution board. II or I depends on the power supply specification of the main unit.
- *2 Pollution Degree 2:
Describes the degree to which a solid, liquid, or gas which deteriorates dielectric strength or surface resistivity is adhering.
“2” applies to normal indoor atmosphere.
Normally, only non-conductive pollution occurs.
- *3 The CE, UKCA standards for modules represent standards that are met when the module is installed in the main unit.

Construction

- Front panel (terminal): Water and dust-proof, Complies with IEC529-IP20
- Material: Polycarbonate
- Color;
Front: Charcoal grey light (Munsell 10B3.6/0.3 equivalent)
Bezel: Smoke blue (Munsell 4.1PB6.0/4.5 equivalent)
- Dimensions: 45.2 mm(W) x 111 mm(H) x 133.1 mm(D) (D: including terminal cover)
- Weight: Approx. 0.3 kg

Power Supply

Supply from GX/GP, GX60 expandable I/O, GM90PS power supply module.

- Power consumption: 1.4 W or less

Isolation

Digital output CH1	Output circuit	Internal circuit
Digital output CH2		
Digital output CH3		
Digital output CH4		
Digital output CH5		
Digital output CH6		

———— Functional insulation

===== Reinforced insulation

Terminal arrangements

M3 screw terminal

No.	Symbol	No.	Symbol
21	DO4 N.C.	11	DO1 N.C.
22	DO4 COM	12	DO1 COM
23	DO4 N.O.	13	DO1 N.O.
24	DO5 N.C.	14	DO2 N.C.
25	DO5 COM	15	DO2 COM
26	DO5 N.O.	16	DO2 N.O.
27	DO6 N.C.	17	DO3 N.C.
28	DO6 COM	18	DO3 COM
29	DO6 N.O.	19	DO3 N.O.
30	Not Used	20	Not Used

External Dimensions

M3 screw terminal

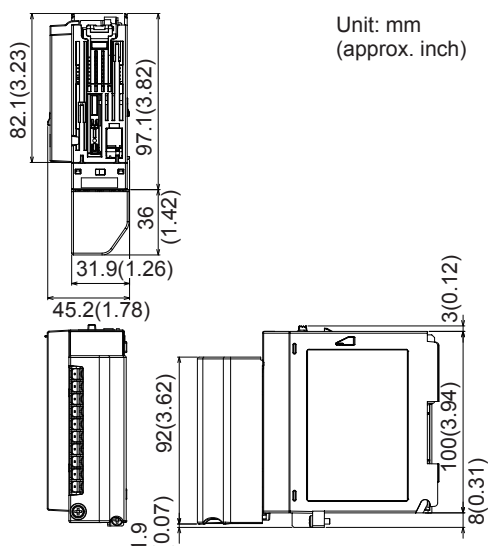

Normal Operating Conditions

For normal operating conditions of this module, please refer to the General Specifications of the device (GX/GP, I/O Base Unit, or GM) that this module is mounted. However, excluding the shock at energization.

GX Specifications: GS 04L51B01-01EN

GP Specifications: GS 04L52B01-01EN

I/O Base Unit (Expandable I/O): This General Specifications

GM Specifications: GS 04L55B01-01EN

Transport and Storage Conditions

Same as the GX90XA.

Installation limitations

When using the GX90WD digital input/output modules and GX90UT PID control modules together, up to a total of 10 modules can be installed.

DIGITAL INPUT/OUTPUT MODULE (Model GX90WD)



GX90WD

Digital input/output module can be used one module on GX/GP main unit, Expandable I/O, GM main unit, and GM sub unit.

Digital Input Specifications

- Application: Remote control input, pulse input*¹, etc
 - Number of inputs: 8
 - input type: DI, pulse*¹
 - Measurement interval: 100 ms (shortest)
 - Input type: Open collector or Voltage-free contact
 - Insulation type: Photocoupler, Trance (power supply)
 - Contact rating: Use an external contact of 12 VDC and 20 mA or more.
 - Input resistance: Approx. 2.4 k Ω
 - Allowable input voltage: +10 V
 - ON/OFF detection
 - Open collector contact input:
 - Voltage in ON state: 0.5 V DC or less
 - Leakage current in OFF state: 0.5 mA or less
 - Voltage-free contact input:
 - Contact resistance in ON state: 200 Ω or less
 - Contact resistance in OFF state: 50 k Ω or more
 - Number of common: 1 (1 point/8 channels)
 - Terminal type: M3 screw terminal
 - Withstand voltage
 - Between the input terminals and the internal circuit: 1500 V AC for one minute
 - Insulation resistance:
 - Between the input terminals and the internal circuit: 20 M Ω or greater at 500 VDC
- [Pulse input specifications]¹
- Counting system: The rising edge of the pulse is counted.
 - Open collector: The signal level at the input terminal changes from high to low.
 - Voltage-free contact: The contact changes from open to close.
 - Max. pulse period:
 - 250 Hz (The chattering filter: Off)
 - 125 Hz (The chattering filter: On)
 - Min. detection pulse width: Low (close), High (open), both is 2 ms or more
 - Pulse detection period: 1 ms
 - Pulse measuring accuracy: ± 1 pulse
 - Pulse count interval: measurement interval
 - Filter: The chattering filter can be switched On/Off*.

* When the chattering filter is off, connect GX/GP/GM so that it is not affected by the noise.

*1 MATH function (optional code /MT) is required.

Digital Output Specifications

- Application: Alarm output, etc
- Number of outputs: 6
- Output update interval: 100 ms (shortest)
- Output type: Relay contact output, SPDT (NO-C-NC)
- Insulation type: Mechanical
- Rated load voltage:
 - Max. 150 VAC when connected to the mains circuit (primary power source).
 - Max. 250 VAC when connected to a circuit (secondary power source) derived from the mains circuit (primary power source) of up to 300V AC, or Max. 30 V DC.
- Maximum voltage between output terminal channels: 250 V AC, Basic insulation
- Max. load current: 2 A (DC)/2 A (AC), resistance load, each channel
- Min. load voltage/current: 5 V DC/10 mA
- Recommended replacement periods of contact:
 - Mechanical 5,000,000 more ON-OFF operations
 - Electrical 30,000 more ON-OFF operations (250 V AC 2 A or 30 V DC 2 A, resistance load)
- Number of common: 6 (All-contact independent)
- Terminal type: M3 screw terminal
- Withstand voltage
 - Between the output terminals and the internal circuit: 2700 V AC for one minute
 - Between the output terminals: 1350 V AC for one minute
- Insulation resistance:
 - Between the output terminals and the internal circuit: 20 M Ω or greater at 500 VDC
 - Between the output terminals: 20 M Ω or greater at 500 VDC

Safety and EMC Standards

- CSA:
 - CSA C22.2 No. 61010-1,
 - Overvoltage Category II or I*¹, Pollution Degree 2*²
- UL:
 - UL 61010-1(CSA NRTL/C),
 - Overvoltage Category II or I*¹, Pollution Degree 2*²
- CE, UKCA/EMC directive*³:
 - EN 61326-1 Class A Table 2(For use in industrial locations) compliant
 - EN 61000-3-2 compliant
 - EN IEC 61000-3-2 compliant
 - EN 61000-3-3 compliant
 - EN 55011 Class A Group 1 compliant
- CE, UKCA/Low voltage directive*³:
 - EN 61010-1 compliant,
 - Overvoltage Category II or I*¹, Pollution Degree 2*²
- CE, UKCA/EU RoHS directive*³: EN IEC 63000
- WEEE Directive: Compliant
- EMC Regulatory Arrangement in Australia and New Zealand (RCM): EN 55011 Class A Group 1 compliant
- KC marking: KS C9811, KS C9610-6-2 compliant

*1 Overvoltage Category: Describes a number which defines a transient overvoltage condition. Implies the regulation for impulse withstand voltage. Applies to electrical equipment which is supplied from the fixed installation like a distribution board. II or I depends on the power supply specification of the main unit.

- *2 Pollution Degree 2: Describes the degree to which a solid, liquid, or gas which deteriorates dielectric strength or surface resistivity is adhering. "2" applies to normal indoor atmosphere. Normally, only non-conductive pollution occurs.
- *3 The CE, UKCA standards for modules represent standards that are met when the module is installed in the main unit.

Construction

- Front panel (terminal): Water and dust-proof, Complies with IEC529-IP20
- Material: Polycarbonate
- Color;
Front: Charcoal grey light (Munsell 10B3.6/0.3 equivalent)
Bezel: Smoke blue (Munsell 4.1PB6.0/4.5 equivalent)
- Dimensions: 45.2 mm(W) x 111 mm(H) x 133.1 mm(D) (D: including terminal cover)
- Weight: Approx. 0.3 kg

Power Supply

Supply from GX/GP, GX60 expandable I/O, GM90PS power supply module.

- Power consumption: 1.6 W or less

Isolation

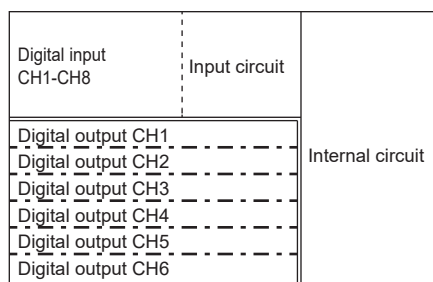

- Functional insulation
 - - - - Basic insulation
 ===== Reinforced insulation

Note: Since the insulation specification between output terminal channels is basic insulation, connect so that the potential difference between adjacent channels does not exceed 30 V AC or 60 V DC. If the potential difference from adjacent channel exceeds 30 V AC or 60 V DC, insert an unconnected channel between the two channels.

Terminal arrangements

M3 screw terminal

No.	Symbol	No.	Symbol	No.	Symbol
301	DI3	201	DI2	101	DI1
302	DI6	202	DI5	102	DI4
303	DI COM	203	DI8	103	DI7
304	Not Used	204	Not Used	104	Not Used
305	DO1 N.O.	205	DO1 COM	105	DO1 N.C.
306	DO2 N.O.	206	DO2 COM	106	DO2 N.C.
307	DO3 N.O.	207	DO2 COM	107	DO3 N.C.
308	DO4 N.O.	208	DO4 COM	108	DO4 N.C.
309	DO5 N.O.	209	DO5 COM	109	DO5 N.C.
310	DO6 N.O.	210	DO6 COM	110	DO6 N.C.

External Dimensions

M3 screw terminal

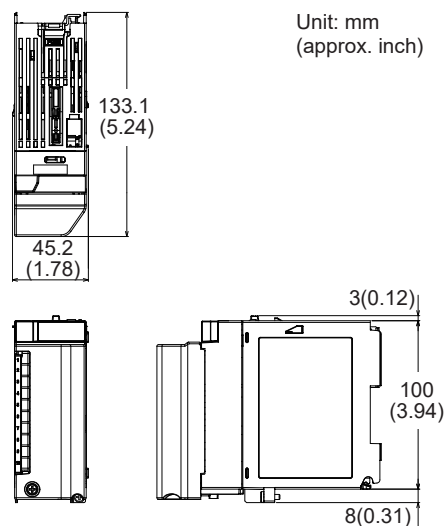

Normal Operating Conditions

For normal operating conditions of this module, please refer to the General Specifications of the device (GX/GP, I/O Base Unit, or GM) that this module is mounted. However, excluding the shock at energization.

GX Specifications: GS 04L51B01-01EN

GP Specifications: GS 04L52B01-01EN

I/O Base Unit (Expandable I/O): This General Specifications

GM Specifications: GS 04L55B01-01EN

Transport and Storage Conditions

Same as the GX90XA.

Installation limitations

- A single module can be installed in each unit.
- When using the GX90YD digital output modules and GX90UT PID control modules together, up to a total of 10 modules can be installed.
- When the measurement mode is High speed, a single module, either this module or the GX90XD, can be installed. DI input is fixed to remote mode. Measurement and recording are not possible.
The DO function cannot be used.

PULSE INPUT MODULE (Model GX90XP)



GX90XP

- Application: Pulse input (flow sum and the like)
- Number of inputs: 10
- Measurement interval: 100 ms (shortest)
- Input type: Contact (open collector, voltage-free contact), level (5 V logic)
- Input format: Pulled up to approx. 5 V through 5 k Ω , common potential shared within the same module
- Input range: Up to 20 kHz*
 - * 30 Hz when the chattering filter is in use (On)
- Minimum detection pulse width: 25 μ s*
 - * 15 ms when the chattering filter is in use (On)
- Measurement accuracy: Count \pm 1 pulse
For integration computation *, the following accuracies are added.
Computation start: +1 scan interval
Computation stop: -1 scan interval
* Integration requires the math function (/MT option).
- Chattering filter: Removes chattering up to 5 ms (can be turned on/off on each channel)
* When the chattering filter is off, connect GX/GP/GM so that it is not affected by the noise.
- Input threshold level:
 - Contact (open collector, voltage-free contact):
Counted when a change from 100 k Ω or higher to 200 Ω or lower is detected
 - Level (5 V logic):
Counted when a change from 1 V or lower to 3 V or higher is detected
- Hysteresis width: Approx. 0.2 V
- Contact, transistor rating:
 - Contact: 15 V DC or higher and 30 mA or higher rating. Minimum applicable load current 1 mA or less.
 - Transistor: With the following ratings: Vce > 15 V DC, Ic > 30 mA
- Allowable input voltage: \pm 10 V DC
- Insulation type: Photocoupler isolation, transformer isolation
- Terminal type: M3 screw terminal or clamp terminal
- Withstand voltage:
 - Between the input terminals and the internal circuit: 1500 V AC for 1 minute
- Insulation resistance:
 - Between the input terminals and the internal circuit: 20 M Ω or greater at 500 V DC

Safety and EMC Standards

- CSA:
 - CSA C22.2 No. 61010-1, Overvoltage Category II or I^{*1}, Pollution Degree 2^{*2}
 - UL:
 - UL 61010-1(CSA NRTL/C), Overvoltage Category II or I^{*1}, Pollution Degree 2^{*2}
 - CE, UKCA/EMC directive^{*3}:
 - EN 61326-1 Class A Table 2(For use in industrial locations) compliant
 - EN 61000-3-2 compliant
 - EN IEC 61000-3-2 compliant
 - EN 61000-3-3 compliant
 - EN 55011 Class A Group 1 compliant
 - CE, UKCA/Low voltage directive^{*3}:
 - EN 61010-1 compliant, Overvoltage Category II or I^{*1}, Pollution Degree 2^{*2}
 - CE, UKCA/EU RoHS directive^{*3}: EN IEC 63000
 - WEEE Directive: Compliant
 - EMC Regulatory Arrangement in Australia and New Zealand (RCM): EN 55011 Class A Group 1 compliant
 - KC marking: KS C9811, KS C9610-6-2 compliant
- *1 Overvoltage Category: Describes a number which defines a transient overvoltage condition. Implies the regulation for impulse withstand voltage. Applies to electrical equipment which is supplied from the fixed installation like a distribution board. II or I depends on the power supply specification of the main unit.
- *2 Pollution Degree 2: Describes the degree to which a solid, liquid, or gas which deteriorates dielectric strength or surface resistivity is adhering. "2" applies to normal indoor atmosphere. Normally, only non-conductive pollution occurs.
- *3 The CE, UKCA standards for modules represent standards that are met when the module is installed in the main unit.

Construction

- Front panel (terminal): Water and dust-proof, Complies with IEC529-IP20
- Material: Polycarbonate
- Color;
 - Front: Charcoal grey light (Munsell 10B3.6/0.3 equivalent)
 - Bezel: Smoke blue (Munsell 4.1PB6.0/4.5 equivalent)
- Dimensions: 45.2 mm(W) x 111 mm(H) x 133.1 mm(D) (D: including terminal cover)
- Weight: Approx. 0.3 kg

Power Supply

Supply from GX/GP, GX60 expandable I/O, GM90PS power supply module.

- Power consumption: 0.9 W or less

Isolation

Pulse input CH1	Input circuit	Internal circuit
Pulse input CH2		
Pulse input CH3		
Pulse input CH4		
Pulse input CH5		
Pulse input CH6		
Pulse input CH7		
Pulse input CH8		
Pulse input CH9		
Pulse input CH10		

———— Functional insulation

----- Non-isolated

Terminal arrangements

M3 screw terminal/Clamp terminal

No.	Symbol	No.	Symbol
21	CH6 +	11	CH1 +
22	CH6 -	12	CH1 -
23	CH7 +	13	CH2 +
24	CH7 -	14	CH2 -
25	CH8 +	15	CH3 +
26	CH8 -	16	CH3 -
27	CH9 +	17	CH4 +
28	CH9 -	18	CH4 -
29	CH10 +	19	CH5 +
30	CH10 -	20	CH5 -

* Negative terminal (common) potential shared

External Dimensions

M3 screw terminal

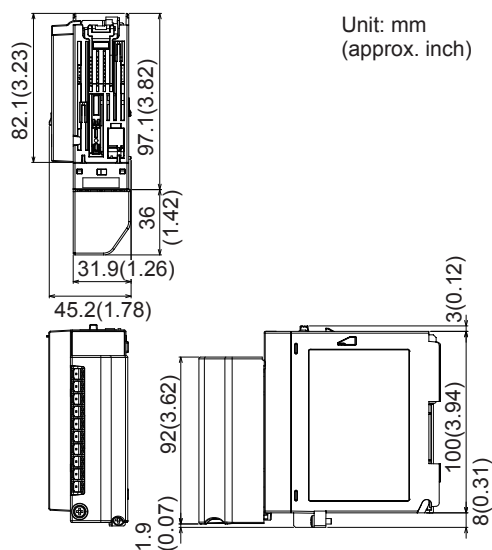

Clamp terminal

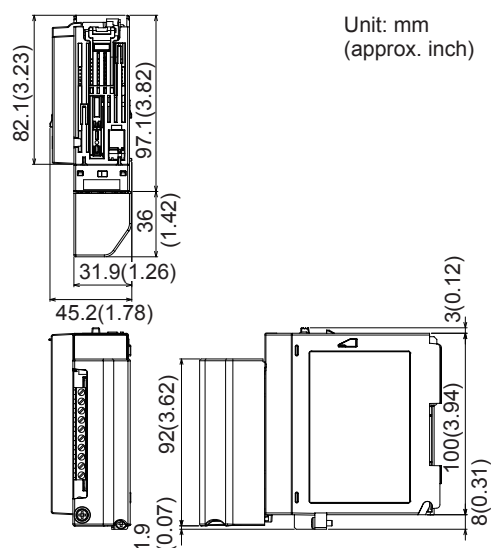

Normal Operating Conditions

For normal operating conditions of this module, please refer to the General Specifications of the device (GX/GP, I/O Base Unit, or GM) that this module is mounted.

GX Specifications: GS 04L51B01-01EN

GP Specifications: GS 04L52B01-01EN

I/O Base Unit (Expandable I/O):

GS 04L53B00-01EN

GM Specifications: GS 04L55B01-01EN

Transport and Storage Conditions

Same as the GX90XA.

ANALOG OUTPUT MODULE (Model GX90YA)



GX90YA

- Application: Retransmission output, Manual output
- Number of outputs: 4 (isolated between channels)
- Output type: 4 to 20mA or 0 to 20mA
- Output update interval: 100 ms (shortest)
- Load resistance: 600Ω or less
- Output range: 0 to 22mA
- Output accuracy: $\pm 0.1\%$ of F.S. (1mA or more) (F.S.=20mA)
- Resolution: 0.002%
- Operating temperature range: -20 to 50°C
- Terminal type: M3 screw terminal or Clamp terminal
- Withstand voltage
Between the output terminals and the internal circuit: 1500 V AC for one minute
Between the output terminals and the output terminals: 500 V AC for one minute
- Insulation resistance:
Between the output terminals and the internal circuit: 20 MΩ or greater at 500 VDC
Between the output terminals and the output terminal: 20 MΩ or greater at 500 VDC

Safety and EMC Standards

- CSA:
CSA C22.2 No. 61010-1,
Overvoltage Category II or I¹, Pollution Degree 2²
- UL:
UL 61010-1(CSA NRTL/C),
Overvoltage Category II or I¹, Pollution Degree 2²
- CE, UKCA/EMC directive³:
EN 61326-1 Class A Table 2(For use in industrial locations) compliant
EN 61000-3-2 compliant
EN IEC 61000-3-2 compliant
EN 61000-3-3 compliant
EN 55011 Class A Group 1 compliant
- CE, UKCA/Low voltage directive³
EN 61010-1 compliant,
Overvoltage Category II or I¹, Pollution Degree 2²
- CE, UKCA/EU RoHS directive³: EN IEC 63000
- WEEE Directive: Compliant
- EMC Regulatory Arrangement in Australia and New Zealand (RCM): EN 55011 Class A Group 1 compliant
- KC marking: KS C9811, KS C9610-6-2 compliant

- *1 Overvoltage Category: Describes a number which defines a transient overvoltage condition. Implies the regulation for impulse withstand voltage. Applies to electrical equipment which is supplied from the fixed installation like a distribution board. II or I depends on the power supply specification of the main unit.
- *2 Pollution Degree 2:
Describes the degree to which a solid, liquid, or gas which deteriorates dielectric strength or surface resistivity is adhering.
“2” applies to normal indoor atmosphere.
Normally, only non-conductive pollution occurs.
- *3 The CE, UKCA standards for modules represent standards that are met when the module is installed in the main unit.

Construction

- Front panel (terminal): Water and dust-proof, Complies with IEC529-IP20
- Material: Polycarbonate
- Color;
Front: Charcoal grey light (Munsell 10B3.6/0.3 equivalent)
Bezel: Smoke blue (Munsell 4.1PB6.0/4.5 equivalent)
- Dimensions: 45.2 mm(W) x 111 mm(H) x 133.1mm(D)
(D: including terminal cover)
- Weight: Approx. 0.2 kg

Power Supply

Supply from GX/GP, GX60 expandable I/O, GM90PS power supply module.

- Power consumption: 3 W or less

Isolation

Analog output CH1	Internal circuit
Analog output CH2	
Analog output CH3	
Analog output CH4	

———— Functional insulation

Terminal arrangements

M3 screw terminal/Clamp terminal

Term. No.	Symbol
11	CH1 +
12	-
13	CH2 +
14	-
15	CH3 +
16	-
17	CH4 +
18	-
19	Not Used
20	Not Used

D/A Calibration Value

Two types of D/A calibration values (factory shipment setting and user setting) can be saved. If the user setting is not proper, it can be restored to the calibration value at factory shipment.

External Dimensions

M3 screw terminal/Clamp terminal

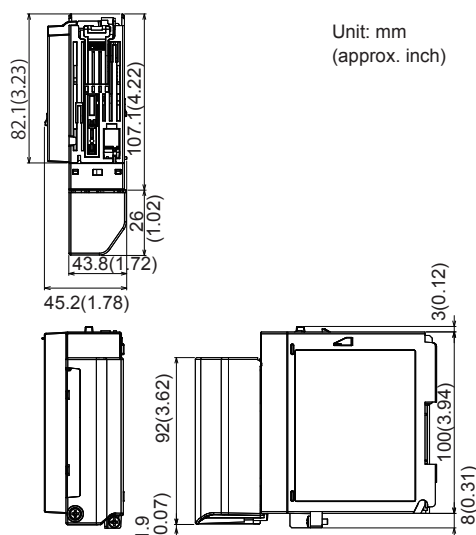

Normal Operating Conditions

For normal operating conditions of this module, please refer to the General Specifications of the device (GX/GP, I/O Base Unit, or GM) that this module is mounted.

GX Specifications: GS 04L51B01-01EN

GP Specifications: GS 04L52B01-01EN

I/O Base Unit (Expandable I/O): GS 04L53B00-01EN

GM Specifications: GS 04L55B01-01EN

Transport and Storage Conditions

Same as the GX90XA.

Effects of Operating Conditions

- Influence of power supply voltage variation: Accuracy is satisfied in the range of rated power supply voltage.
- temperature influence: ± 200 ppm of F.S./ $^{\circ}\text{C}$ or less

Installation Conditions

- Installation limitations by unit
 - GX10/GP10: Up to 1 module
 - GX20/GP20: Up to 2 module
 - GM10/GX60: Up to 2 modules per unit
- System limitations
 - GX10/GX20-1: Up to 10 module
 - GX20-2: Up to 12 module
- If you want to use this module simultaneously with the GX90XA-04-H0 (high-speed universal type) module, the following limitation applies to the number of modules (including expansion modules) that can be used.

Model	Number of modules
GP10 (12 V DC)	Up to two modules total
GX20/GP20	Up to nine modules total
GX60	No limit
GM10 Single unit	Up to seven modules total
GM10 Multi unit (main unit/ Sub unit)	No limit

- Performing thermocouple measurement on a slot left of this module (above, below, left, and right for the GX20/GP20) may increase RJC errors on that module.

■ MODEL AND SUFFIX CODES

Analog input module, Digital I/O module (sold separately):

MODEL and SUFFIX Code (GX90XA)

Model	Suffix Code				Description
GX90XA					Analog Input Module
Number of channels	-04				4 channels (Type -H0 only)
	-06				6 channels (Type -R1 only)
	-10				10 channels (Type -C1, -L1, -U2, -T1, -V1)
Type	-C1				Current, scanner type (isolated between channels)
	-L1				DCV/TC/DI, low withstand voltage scanner type (isolated between channels)
	-U2				Universal, Solid state relay scanner type (3-wire RTD b-terminal common)
	-T1				DCV/TC/DI, Electromagnetic relay scanner type (isolated between channels)
	-H0				High-speed universal, individual A/D type (isolated between channels)
	-R1				4-wire RTD/resistance, scanner type (isolated between channels)
	-V1				DCV/TC/DI, high withstand voltage scanner type (isolated between channels)
-		N			Always N
Terminal form			-3		Screw terminal (M3)
			-C		Clamp terminal
Area			N		General

MODEL and SUFFIX Code (GX90XD)

Model	Suffix Code				Description
GX90XD					Digital Input Module*
Number of channels	-16				16 channels
Type	-11				Open collector/Non-voltage, contact (shared common), Rated 5 VDC
-		N			Always N
Terminal form			-3		Screw terminal (M3)
			-C		Clamp terminal
Area			N		General

* If you want to integrate pulse input, a math function (/MT option) is required in the GX/GP/GM main unit.

MODEL and SUFFIX Code (GX90YD)

Model	Suffix Code				Description
GX90YD					Digital Output Module
Number of channels	-06				6 channels
Type	-11				Relay, SPDT(NO-C-NC)
-		N			Always N
Terminal form			-3		Screw terminal (M3)
Area			N		General

MODEL and SUFFIX Code (GX90WD)

Model	Suffix Code				Description
GX90WD					Digital Input/Output Module*
Number of channels	-0806				8 channel DIs, 6 channel DOs
Type	-01				Open collector/non-voltage contact (shared common), rated 5 VDC; Relay, SPDT (NO-C-NC)
-		N			Always N
Terminal form			-3		Screw terminal (M3)
Area			N		General

* If you want to integrate pulse input, a math function (/MT option) is required in the GX/GP/GM main unit.

MODEL and SUFFIX Code (GX90XP)

Model	Suffix Code				Description
GX90XP					Pulse loutput Module*
Number of channels	-10				10 channels
Type		-11			DC voltage/open collector/non-voltage contact (shared common), rated 5 VDC
-			N		Always N
Terminal form				-3	Screw terminal (M3)
				-C	Clamp terminal
Area				N	General

* If you want to integrate pulse input, a math function (/MT option) is required in the GX/GP/GM main unit.

MODEL and SUFFIX Code (GX90YA)

Model	Suffix Code				Description
GX90YA					Analog Output Module
Number of channels	-04				4 channels
Type		-C1			Current (isolated between channels)
-			N		Always N
Terminal form				-3	Screw terminal (M3)
				-C	Clamp terminal
Area				N	General

■ Optional Accessories (Sold Separately)

Product	Model/part no.
Shunt resistor for M3 terminal (250 $\Omega \pm 0.1\%$)	415940
Shunt resistor for M3 terminal (100 $\Omega \pm 0.1\%$)	415941
Shunt resistor for M3 terminal (10 $\Omega \pm 0.1\%$)	415942
Shunt resistor for Clamp terminal (250 $\Omega \pm 0.1\%$)	438920
Shunt resistor for Clamp terminal (100 $\Omega \pm 0.1\%$)	438921
Shunt resistor for Clamp terminal (10 $\Omega \pm 0.1\%$)	438922

Calibration certificate (sold separately)

When ordering the GX10/GX20/GP10/GP20 with options (analog input), the calibration certificate for the modules is included in and shipped with the calibration certificate of the main unit.

When ordering an analog input module, each module gets its own calibration certificate (one certificate per module).

Test certificate (QIC, sold separately)

When ordering the GX10/GX20/GP10/GP20 with options (analog/digital I/O), the QIC for each module is included in and shipped with the QIC of the main unit.

When ordering analog input modules and digital I/O modules, each module gets its own QIC (one QIC per module).

User's Manual

Product user's manuals can be downloaded or viewed at the following URL. To view the user's manual, you need to use Adobe Reader 7 or later by Adobe Systems.

URL: www.smartdacplus.com/manual/en/

Product Purchase Specifications

- The GX10/GX20/GP10/GP20 is composed of the main unit, I/O modules, the expandable I/O, and the expansion module.
There are two ways to purchase I/O modules.
One way is to purchase them individually by specifying models GX90XA, GX90XD, GX90YD, GX90WD, GX90XP, and GX90YA, .
The other way is to purchase them as an option (/UCxx or /USxx). Purchasing them as an option is convenient, but this places limitations on the number of analog inputs that you can obtain.
If you want to use more than 51 channels, please purchase the I/O modules individually.
- The GM is composed of the data aquisition module, the power supply module, the module base, the I/O module, and the expansion module.
Please purchase the modules and module base individually.

■ Basic Conditions and Individual Contracts at the Time of Purchase

The warranty for this product is defined in the basic conditions and individual contracts at the time of purchase.

The individual conditions are as follows.

- **Validation**

Yokogawa does not guarantee the final outcome of validation work even if there is a defect in the product. For the warranty of validation services, please contact the company that performed the validation work.

- **Warranty period of the firmware**

The firmware warranty period is one year.

Please refer to the following URL for the procedure to update the firmware and the method to download the firmware.

<https://myportal.yokogawa.com/>

Trademarks

The TCP/IP software used in this product and the document for that TCP/IP software are based in part on BSD networking software, Release 1 licensed from The Regents of the University of California.

- SMARTDAC+ is a registered trademark or trademark of Yokogawa Electric Corporation.
- Microsoft, MS and Windows are registered trademarks or trademarks of Microsoft Corporation USA.
- Pentium are registered trademarks of Intel Corporation.
- Modbus is a registered trademark of AEG Schneider.
- Other company names and product names appearing in this document are registered trademarks or trademarks of their respective holders.

Blank

General Specifications

GS 04L53B01-31EN

GX90UT PID Control Module **SMARTDAC+**

GX10/GX20/GP10/GP20 Paperless Recorder
Data Acquisition System GM

Loop Control Function, Program Control Function (/PG Option)

■ Overview

The GX90UT is a PID control module that connects to the GX/GP, expandable I/O units, and GM main units and sub units.

- The GX90UT PID Control Module can perform PID control on up to two loops. It is equipped with two control inputs, two control outputs, eight digital inputs, and eight digital outputs. In addition to single loop control, cascade control and loop control with PV switching are possible. For the control output, you can select current output or voltage pulse for each loop.
- Installing the PID Control Module in the GX/GP/GM enables PID control of up to 20 loops/system (up to 6 loops/system for the GX10/GP10/GX20-1/GP20-1/GM10-1). In addition to control loop monitoring and the control group screen for convenient operation, adjustment using the tuning screen is available.
- Adding the /PG option to the GX/GP/GM main unit allows 99 patterns and 99 segments (1 pattern) of program patterns to be stored in the main unit. Further, up to 32 time events and 32 PV events can be set for each segment.
- The GX90UT control data can be acquired and recorded in the GX/GP/GM main unit.

■ PID Control Module Specifications (Model: GX90UT)

Use

Controlling temperature, flow rate, pressure, etc.

Analog Input

- Measurement types: DC voltage (DCV), standard signal, type (TC), resistance temperature detector (RTD), DI (LEVEL, no-voltage contact), DC current (when external shunt resistor is connected)
- Number of measurement points: 2
- Scan period: Same as the control period
- Input format: Floating unbalanced input, isolation between channels
- Measuring range/accuracy:
See the table in "Measuring Range/Accuracy" (page 3).
- Burnout detection: Upscale, downscale, and off can be specified (for each channel).
Detectable inputs: Thermocouple, resistance temperature detector, standard signal
Detection condition:
Thermocouple: Detection current: approx. 100 nA, superposed electric current system
RTD: Detection current: approx. 100 nA, superposed electric current system



GX90UT

Standard signal: Normal: within measurement range
Disconnection: based on the burnout criteria setting

The criteria is set as a percentage of the specified span width.

Lower limit: -20.0 to -5.0%

Upper limit: 105 to 120%

- External input resistance:
DC voltage, thermocouple: 2 k Ω or less
RTD: 10 Ω or less per line (the same resistance for all three lines)
- Input bias current: ± 10 nA or less (except when burnout detection is set)
- Measurement current (RTD): Approx. 1 mA, approx. 1.6 mA
- Input resistance:
10 M Ω or more for thermocouple/DC voltage (1 V range or lower)
About 1 M Ω for DC voltage (2 V range or higher)/standard signal
- Allowable signal source resistance
2 k Ω or less for thermocouple/DC voltage (1 V range or less)
- Effect of signal source resistance:
 ± 10 μ V/1 k Ω or less for thermocouple/DC voltage (1 V range or less)
 $\pm 0.15\%$ /1 k Ω or less for DC voltage (2 V range or higher)/standard signal
- Effect of wiring resistance:
Fluctuation per 10 Ω change per line (the same resistance for all three lines)
RTD (100 Ω type or higher): $\pm 0.1^\circ\text{C}/10$ Ω
RTD (50 Ω type or lower): $\pm 1^\circ\text{C}/10$ Ω
- Allowable input voltage:
Thermocouple, DC voltage (1 V range or lower), RTD, DI(contact input): ± 10 VDC
DC voltage (2 V range or higher), DI (level): ± 60 VDC
- Normal-mode rejection ratio: 40 dB or more
- Common mode rejection ratio: 120 dB or more

- Normal mode voltage:
Thermocouple, DC voltage, DI (voltage): 1.2 times
the range rating or less
Standard signal 0.4-2 V range: 2.4 V
Standard signal 1-5 V range: 6 V
RTD 100 Ω type or higher: 50 mV peak
RTD 50 Ω type or lower: 10 mV peak
- Common mode voltage:
30 VACrms or ± 60 VDC
Maximum common mode noise voltage: 250 VACrms
- Common mode voltage between channels:
30 VACrms or ± 60 VDC
Maximum common mode noise voltage: 250 VACrms
- Reference junction compensation accuracy:
When measuring temperature greater than
or equal to 0 °C, using a power supply
frequency noise reduction filter, and when the
temperature of the input terminal is balanced
Type K, E, J, T, N, XK GOST:
 $\pm 0.5^{\circ}\text{C}$ ($23^{\circ}\text{C} \pm 2^{\circ}\text{C}$)
 $\pm 0.7^{\circ}\text{C}$ (0 to 50°C)
 $\pm 1.0^{\circ}\text{C}$ (-20 to 60°C)
Type R, S, W, L, U, WRe3-25, PLATINEL II, NiNiMo,
W/WRe26, N (AWG14):
 $\pm 1.0^{\circ}\text{C}$ ($23^{\circ}\text{C} \pm 2^{\circ}\text{C}$)
 $\pm 1.4^{\circ}\text{C}$ (0 to 50°C)
 $\pm 2.0^{\circ}\text{C}$ (-20 to 60°C)
Type KpvsAu7Fe:
 ± 1.0 K ($23^{\circ}\text{C} \pm 2^{\circ}\text{C}$)
 ± 1.4 K (0 to 50°C)
 ± 2.0 K (-20 to 60°C)
Type B, PR20-40: internal RJC fixed at 0°C
- Calibration correction function:
Mode: Linearizer approximation, linearizer bias
(number of correction points: 12), correction
factor
- First-order lag input filter: on/off switchable (for each
channel)
Time constant: 1 to 120 s
- Reference junction compensation:
internal/external switchable (for each
channel)
- Input calculation: off, linear scaling, square root
calculation (for each channel)*DC
voltage/standard signal
- Bias function: Bias to add to input values can be
specified (for each channel).

Measuring Range/Accuracy¹

Input type	Range	Measurement range	Measurement accuracy (digital display)	Digital display highest resolution
DC voltage	20 mV	-20.000 to 20.000 mV	±(0.05% of rdg+12μV)	1 μV
	60 mV	-60.00 to 60.00 mV	±(0.05% of rdg+0.02 mV)	10 μV
	200 mV	-200.00 to 200.00 mV	±(0.05% of rdg+0.03 mV)	10 μV
	1 V	-1.0000 to 1.0000 V	±(0.05% of rdg+0.2 mV)	100 μV
	2 V	-2.0000 to 2.0000 V	±(0.05% of rdg+1.2 mV)	100 μV
	6 V	-6.000 to 6.000 V	±(0.05% of rdg+2 mV)	1 mV
	20 V	-20.000 to 20.000 V	±(0.05% of rdg+3 mV)	1 mV
	50 V	-50.00 to 50.00 V	±(0.05% of rdg+0.02 V)	10 mV
Standard signal	0.4-2V	0.3200 to 2.0800 V	±(0.05% of rdg+1.2 mV)	100 μV
	1-5V	0.800 to 5.200 V	±(0.05% of rdg+2 mV)	1 mV
Thermocouple (does not include reference junction compensation accuracy)	R ²	0.0 to 1760.0°C	±(0.05% of rdg+1.0°C)	0.1°C
	S ²	0.0 to 1760.0°C	Except R and S; 0.0 to 800.0°C: ±1.4°C	
	B ²	0.0 to 1820.0°C	B; 400.0 to 800.0°C: ±3.0°C Accuracy not guaranteed for temperatures less than 400.0°C	
	K ²	-270.0 to 1370.0°C	±(0.05% of rdg+0.7°C)	0.1°C
		-200.0 to 500.0°C	Except -200.0 to 0.0°C: ±(0.2% of rdg + 0.7°C) Accuracy not guaranteed for temperatures less than -200.0°C	
	E ²	-270.0 to 800.0°C	±(0.05% of rdg+0.5°C)	0.1°C
	J ²	-200.0 to 1100.0°C	Except -200.0 to 0.0°C: ±(0.2% of rdg + 0.5°C) Accuracy not guaranteed for temperatures less than -200.0°C	0.1°C
	T ²	-270.0 to 400.0°C	±(0.05% of rdg+0.5°C) Except -200.0 to 0.0°C: ±(0.2% of rdg + 0.5°C) Accuracy not guaranteed for temperatures less than -200.0°C	0.1°C
	N ²	-270.0 to 1300.0°C	±(0.05% of rdg+0.7°C) Except -200.0 to 0.0°C: ±(0.5% of rdg + 0.7°C) Accuracy not guaranteed for temperatures less than -200.0°C	0.1°C
	W ³	0.0 to 2315.0°C	±(0.05% of rdg+1.0°C) 1000.0 °C or more: ±0.15% of rdg	0.1°C
L ⁴	-200.0 to 900.0°C	±(0.05% of rdg+0.5°C) Less than 0.0°C: ±(0.25% of rdg + 0.5°C)	0.1°C	
U ⁴	-200.0 to 400.0°C	±(0.05% of rdg+0.5°C) Less than 0.0°C: ±(0.5% of rdg + 0.5°C)	0.1°C	
Thermocouple (does not include reference junction compensation accuracy)	WRe3-25 ⁵	0.0 to 2320.0°C	±(0.05% of rdg+2.0°C) 2000.0 °C or more: ±0.15% of rdg	0.1°C
	KpvsAu7Fe ⁶	0.0 to 300.0 K	±(0.05% of rdg+2.0 K)	0.1 K
	PLATINEL II ⁶	0.0 to 1395.0°C	±(0.05% of rdg+1.0°C)	0.1°C
	PR20-40 ⁷	0.0 to 1900.0°C	±(0.05% of rdg+5.5°C) Accuracy not guaranteed for temperatures less than 800.0°C	0.1°C
	NiNiMo ⁶	0.0 to 1310.0°C	±(0.05% of rdg+0.7°C)	0.1°C
	W/WRe26 ⁸	0.0 to 2320.0°C	±(0.05% of rdg+2.0°C) Accuracy not guaranteed for temperatures less than 300.0°C	0.1°C
	N(AWG14) ⁹	0.0 to 1300.0°C	±(0.05% of rdg+0.7°C)	0.1°C
XK GOST ¹⁰	-200.0 to 600.0°C	±(0.05% of rdg+0.5°C) Less than 0.0°C: ±(0.2% of rdg + 0.5°C)	0.1°C	
RTD (measurement current 1 mA)	Pt100 ¹¹	-200.0 to 850.0°C	±(0.05% of rdg+0.3°C)	0.1°C
		-150.00 to 150.00°C		0.01°C
	JPt100 ¹¹	-200.0 to 550.0°C	±(0.05% of rdg+0.3°C)	0.1°C
		-150.00 to 150.00°C		0.01°C
	Cu100 at 0°C α=0.00425	-50.0 to 150.0°C	±(0.05% of rdg+0.3°C)	0.1°C
	Cu25 at 0°C α=0.00425	-200.0 to 300.0°C	±(0.1% of rdg+0.8°C)	0.1°C
	Cu53 at 0°C α=0.00426035	-50.0 to 150.0°C	±(0.05% of rdg+0.6°C)	0.1°C
	J263B ¹⁷	0.0 to 300.0 K	±0.4 K Less than 40.0 K: ±0.8 K	0.1 K
	Pt25 ¹⁸	-200.0 to 550.0°C	±(0.1% of rdg+0.8°C)	0.1°C
	Ni100 (SAMA)	-200.0 to 250.0°C	±(0.05% of rdg+0.3°C)	0.1°C
	Ni100 (DIN) ¹²	-60.0 to 180.0°C		
	Ni120 ¹³	-70.0 to 200.0°C		
	Pt50 ¹⁴	-200.0 to 550.0°C	±(0.05% of rdg+0.6°C)	0.1°C
	Pt200 WEED	-100.0 to 250.0°C	±(0.05% of rdg+1.0°C)	0.1°C
	Cu100 GOST ¹⁵	-200.0 to 200.0°C	±(0.05% of rdg+0.3°C)	0.1°C
Pt46 GOST ¹⁶	-200.0 to 550.0°C	±(0.05% of rdg+0.6°C)	0.1°C	
Pt100 GOST ¹⁵	-200.0 to 600.0°C	±(0.05% of rdg+0.3°C)	0.1°C	

rdg: reading

Continued

Input type	Range	Measurement range	Measurement accuracy (digital display)	Digital display highest resolution
RTD (measurement current 1.6mA)	Cu10 GE	-200.0 to 300.0°C	±(0.1% of rdg+2.0°C)	0.1°C
	Cu10 L&N	-200.0 to 300.0°C	Guaranteed accuracy range	
	Cu10 WEED	-200.0 to 300.0°C	Cu10 GE: -70.0 to 170.0°C	
	Cu10 BAILEY	-200.0 to 300.0°C	Cu10 L&N: -75.0 to 150.0°C	
	Cu10 at 20°C α=0.00392	-200.0 to 300.0°C	Cu10 WEED: -200.0 to 260.0°C	
	Cu10 at 20°C α=0.00393	-200.0 to 300.0°C	Other than above: -200.0 to 300.0°C	
	Cu10 GOST ¹⁹	-200.0 to 200.0°C	±(0.1% of rdg+2.0°C)	0.1°C
Cu50 GOST ¹⁶	-200.0 to 200.0°C	±(0.05% of rdg+0.6°C)	0.1°C	
DI	Level		Threshold level (V _{th} = 2.4 V) accuracy ± 0.1 V	-
	Contact ²⁰		100 Ω or less: 1 (ON), 10 kΩ or more: 0 (OFF)	-

rdg: reading

1 Under standard operating conditions: 23±2°C, 55±10% RH, supply voltage 90–132, 180–264 V AC, supply frequency within 50/60 Hz ±1%, warm-up of 30 minutes or more, no vibrations or other hindrances to performance.

2 R, S, B, K, E, J, T, N: IEC 60584-1, DIN EN 60584, JIS1602

3 W: W-5%Re/W-26%Re(Hoskins Mfg.Co.) ASTM E988-96

4 L: Fe-CuNi, DIN43710, U: Cu-CuNi, DIN43710

5 WRe3-25: W-3%Re/W-25%Re(Hoskins Mfg.Co.) ASTM E988-96

6 KpvsAu7Fe, PLATINEL II, NiNiMo: ASTM E1751

7 PR20-40: PtRH20%-PtRh40%(Johnson Matthey Plc) ASTM E1751

8 W/WRe26: W/W-26%Re(Hoskins Mfg.Co.) ASTM E1751

9 N(AWG14): NBS

10 XK GOST: Type L (GOST R 8.525-2001)

11 Pt100: JIS C 1604, IEC 60751, DIN EN 60751

JPt100: JIS C1604, JIS C1606

12 Ni100 (DIN): DIN 43760

13 Ni120: McGRAW EDISON COMPANY

14 Pt50: JIS C1604, JIS C1606

15 Cu100 GOST, Pt100 GOST: GOST 6651-2009

16 Cu50 GOST, Pt46 GOST: GOST 6651-94

17 J263B: YOKOGAWA J263*B

18 Pt25: 1/4 the JPt100 resistance

19 Cu10 GOST: 1/10 the Cu100 GOST resistance

20 Detected current value: approx. 10 μA

Measuring accuracy when scaling:

Measuring accuracy when scaling (digits) = measuring accuracy (digits) × scaling span (digits)/measurement span (digits) + 2 digits

* Fractions rounded up

Analog output

- Number of outputs: 2
- Output types: Current, voltage pulse, or DC loop power supply (15 VDC)
 - Current output:
 - Output signal: 4 to 20 mA or 0 to 20 mA (reverse output possible)
 - Load resistance: 600 Ω or less
 - Output: $\pm 0.1\%$ of F.S. Except $\pm 5\%$ of F.S. (F.S.: 20 mA) for 1 mA or less
 - Temperature effect: ± 200 ppm/ $^{\circ}\text{C}$
 - Humidity effect: $\pm 0.05\%$ of F.S. @40 $^{\circ}\text{C}$, 93%RH
 - Long-term drift: $\pm 0.05\%$ of F.S.
 - Voltage pulse output:
 - ON voltage: 12 VDC or more (load resistance of 600 Ω or more)
 - OFF voltage: 0.1 VDC or less
 - Cycle time: 0.5 to 1000.0 s
 - Time resolution: 10 ms or 0.1% of output value, whichever is larger
 - DC loop power supply:
 - Supply voltage: 13.0 to 18.3 V
 - Maximum supply current: about 22 mA (with short-circuit current limiting circuit)
- Output calculation: split computation

Digital Input/Output

Digital Input

- Number of inputs: 8
- Status detection minimum hold time: control period + 50 ms
- Input type: no-voltage contact or open collector
- Isolation type: photocoupler isolation
- Contact rating: 12 VDC or more, 20 mA or more
 - Using a contact with a minimum ON current of 1 mA or less
- Input resistance: about 2.4 k Ω
- Allowable input voltage: 10 V
- Input detection:
 - For open collector contact input
 - ON voltage: 0.5 VDC or less
 - Leakage current when turned off: 0.5 mA or less
 - For no-voltage contact input
 - Contact resistance when turned on: 200 Ω or less
 - Contact resistance when turned off: 50 k Ω or more
- Number of commons: 1
- Application: SP switching, operation mode switching, event input

Digital Output

- Number of outputs: 8
- Output time resolution: 100 ms min.
- Output type: open collector (sink type)
- Isolation type: photocoupler isolation
- Output contact capacity: 24 V DC max., 50 mA
- Application: alarm output, FAIL output, etc.

Withstand voltage

- Between analog input terminals and internal circuit: 1500 V AC for 1 minute
- Between analog output terminals and internal circuit: 1500 V AC for 1 minute
- Between digital input terminals and internal circuit: 1500 V AC for 1 minute
- Between digital output terminals and internal circuit: 1500 V AC for 1 minute
- Between input terminals and output terminals: 1000 V AC for 1 minute

- Between analog input channels: 1000 V AC for 1 minute
- Between analog output channels: 20 M Ω or more at 500 V AC
- Between analog I/O terminals and digital I/O terminals: 1000 V AC for 1 minute

Insulation resistance

- Between analog input terminals and internal circuit: 20 M Ω or more at 500 V DC
- Between analog output terminals and internal circuit: 20 M Ω or more at 500 V DC
- Between digital input terminals and internal circuit: 20 M Ω or more at 500 V DC
- Between digital output terminals and internal circuit: 20 M Ω or more at 500 V DC
- Between input terminals and output terminals: 20 M Ω or more at 500 V DC
- Between analog input channels: 20 M Ω or more at 500 V DC
- Between analog output channels: 20 M Ω or more at 500 V DC
- Between analog I/O terminals and digital I/O terminals: 20 M Ω or more at 500 V DC

Standards Compliance

- CSA:
 - CSA C22.2 No. 61010-1,
 - CSA-C22.2 No. 61010-2-030,
 - CAN/CSA-C22.2 No.61010-2-201^{*4}
 - Overvoltage Category II or I^{*1}, Pollution Degree 2^{*2}, Measurement Category II^{*3}
- UL:
 - UL 61010-1, UL Std. No. 61010-2-030,
 - UL 61010-2-201^{*4} (CSA NRTL/C)
 - Overvoltage Category II or I^{*1}, Pollution Degree 2^{*2}, Measurement Category II^{*3}
- CE, UKCA/EMC directives^{*5}:
 - EN 61326-1 Class A Table 2 (For use in industrial location) compliant
 - EN 61000-3-2 compliant
 - EN IEC 61000-3-2 compliant
 - EN 61000-3-3 compliant
 - EN 55011 Class A Group 1 compliant
- CE, UKCA/Low voltage directives^{*5}:
 - EN 61010-1, EN IEC 61010-2-030,
 - EN IEC 61010-2-201^{*4} compliant
 - Overvoltage Category II or I^{*1}, Pollution Degree 2^{*2}, Measurement Category II^{*3}
- CE, UKCA/EU RoHS directive^{*5}: EN IEC 63000
- WEEE directive:
 - Compliant
- Australia, New Zealand EMC standard (RCM):
 - EN 55011 Class A Group 1 compliant
- KC mark:
 - KS C9811, KS C9610-6-2 compliant

*1 Overvoltage Category: Describes a number which defines a transient overvoltage withstand condition. Implies the regulation for impulse withstand voltage. "II" applies to electrical equipment which is supplied from the fixed installation like a distribution board. II or I depends on the power supply specification of the main unit.

*2 Pollution Degree 2: Describes the degree to which a solid, liquid, or gas which deteriorates dielectric strength or surface resistivity is adhering. "2" applies to normal indoor atmosphere. Normally, only non-conductive pollution occurs.

- *3 Measurement Category II (CAT II): Available in the testing and measuring circuits directly connected to a usage location (receptacle or the like) of a low-voltage main power supply facility. Appliances, portable equipment, etc.
- *4 This product is designed as open equipment under the relevant standard, install it as follows:
 - The GX10/GX20 is designed to be installed in an instrumentation panel. Install it in a location where people cannot touch the terminals carelessly.
 - To make the GP10/GP20 comply with the relevant standard, support the parts of the device other than the front-panel control area with an instrumentation panel or the like, and install it in a location where people cannot touch the terminals carelessly or in a panel.
 - Install the GX60/GM unit in a panel with a door.
 - The instrumentation panel or panel used for support must comply with CSA/UL/EN/IEC 61010-2-201 or must be at least IP1X (degrees of protection) and at least IK09.
 - To comply with the relevant standard, make sure that the style numbers of the GX/GP main unit, GM90PS power supply module, and GX60 I/O base unit are at least 2.
- *5 The CE, UKCA standards for modules represent standards that are met when the module is installed in the main unit.

Construction

- Front panel (terminal) area: Dust-proof and drip-proof, IEC529-IP20
- Material: Polycarbonate
- Color:
 - Front panel: Light charcoal gray (Munsell 10B 3.6/0.3 equivalent)
 - Case: Smoke gray (Munsell 4.1PB 6.0/4.5 equivalent)
- External dimensions: 45.2 (W) x 111 (H) x 133.1 (D) mm (D: depth including the terminal cover)
- Terminal type: M3 screw terminal
- Weight: Approx. 0.3 kg

Power supply

Supplied from GX/GP, GX60, GM90PS

- Power consumption: 2.8 W or less

Isolation

Analog input CH1	Internal circuit
Analog input CH2	
Analog output CH1	
Analog output CH2	
Digital input CH1 to 8	
Digital output CH1 to 8	

———— Functional isolation

Terminal arrangement: M3 screw terminal

No.	Symbol	No.	Symbol	No.	Symbol
301	DI3	201	DI2	101	DI1
302	DI6	202	DI5	102	DI4
303	DI-COM	203	DI8	103	DI7
304	DO3	204	DO2	104	DO1
305	DO6	205	DO5	105	DO4
306	DO-COM	206	DO8	106	DO7
307	AI1(/A)	207	AI1(-/b)	107	AI1(+/B)
308	AI2(/A)	208	AI2(-/b)	108	AI2(+/B)
309	N.C.	209	AO1(-)	109	AO1(+)
310	N.C.	210	AO2(-)	110	AO2(+)

A/D Calibration Value

You can save two types of AD calibration values: factory default values and user-defined values. If there is a problem with user-defined values, they can be reset to factory default calibration values.

External Dimensions

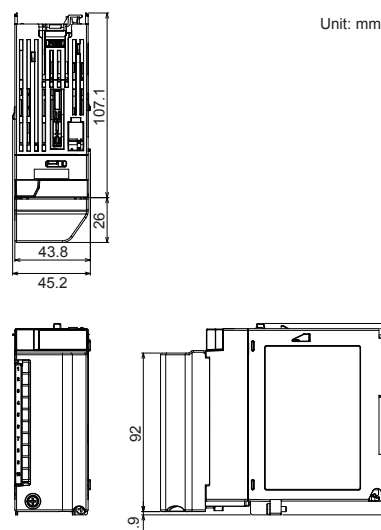

Normal Operating Conditions

- Ambient temperature: -20 to 50°C
However, use it within the ambient temperature range defined for the GX/GP/GM main unit.
For the normal operating conditions of this module, see the specifications of the instrument (GX/GP, expandable I/O, GM) that this module is installed in.
GX specifications: GS 04L51B01-01EN
GP specifications: GS 04L52B01-01EN
Expandable I/O specifications: GS 04L53B00-01EN
GM specifications: GS 04L55B01-01EN

Transport and Storage Conditions

- Ambient temperature: -25 to 70°C
- Ambient humidity: 5 to 95% RH (no condensation)
- Vibration: 10 to 60 Hz, 4.9 m/s² or less
- Shock: 392 m/s² maximum (in packaged condition)

Effects of Operating Conditions

- Effects of ambient temperature:
 - Fluctuation per 10°C change
 - ±(0.05% of rdg + 0.05% of range) or less
 - However, for KpvsAu7Fe, PR20-40: ±(0.05% of rdg + 0.1% of range) or less
 - Cu10Ω or less: ±(0.2% of range + 0.1°C) or less
- Effects of power fluctuation:
 - Meets the accuracy specifications in the rated power supply range
- Effects of magnetic field:
 - Fluctuation in response to a magnetic field of AC (50/60 Hz) 400 A/m is ±(0.1% of rdg + 0.1% of range) or less.

Block Diagram

Single Loop Control Block Diagram

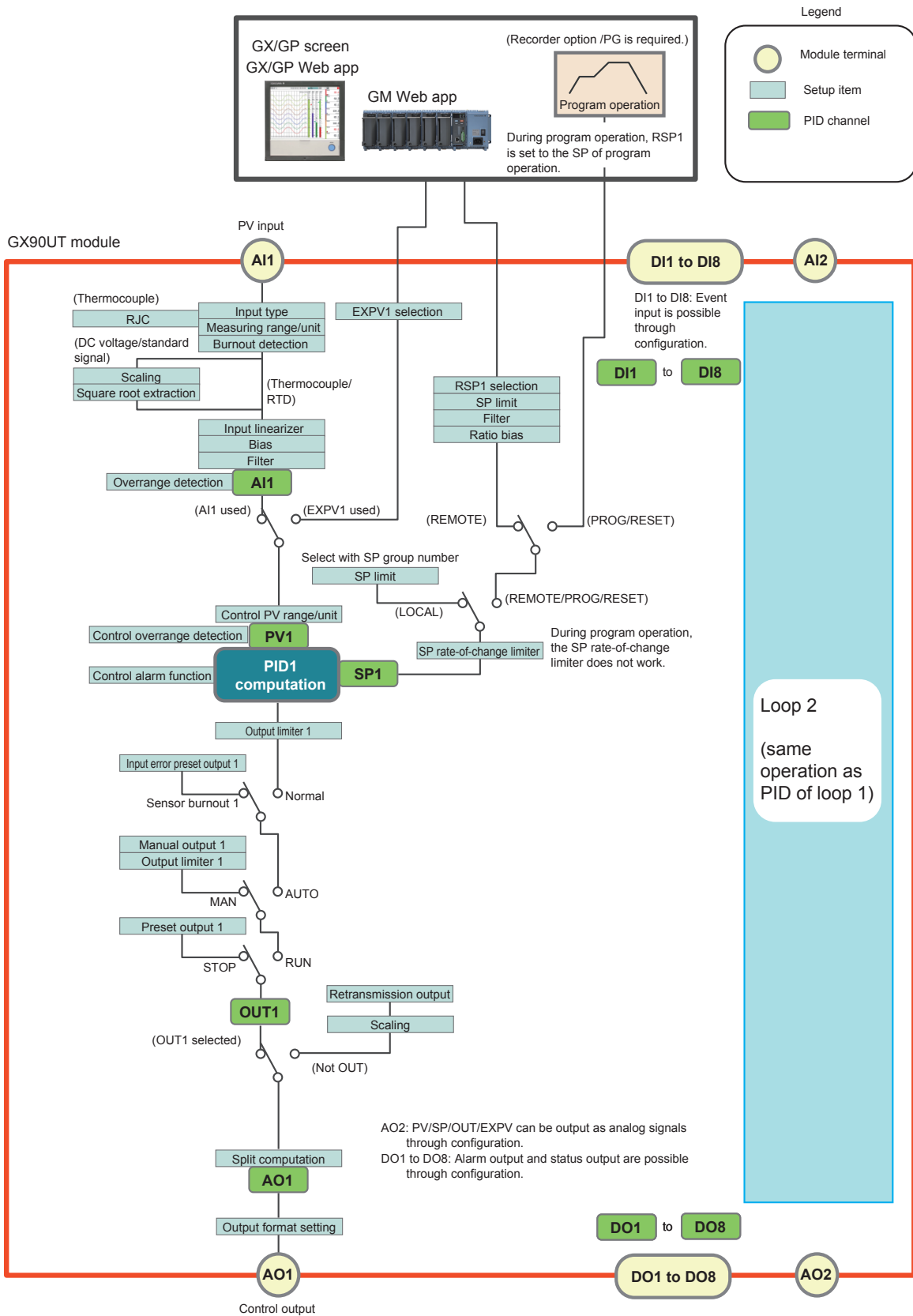

Cascade Control Block Diagram

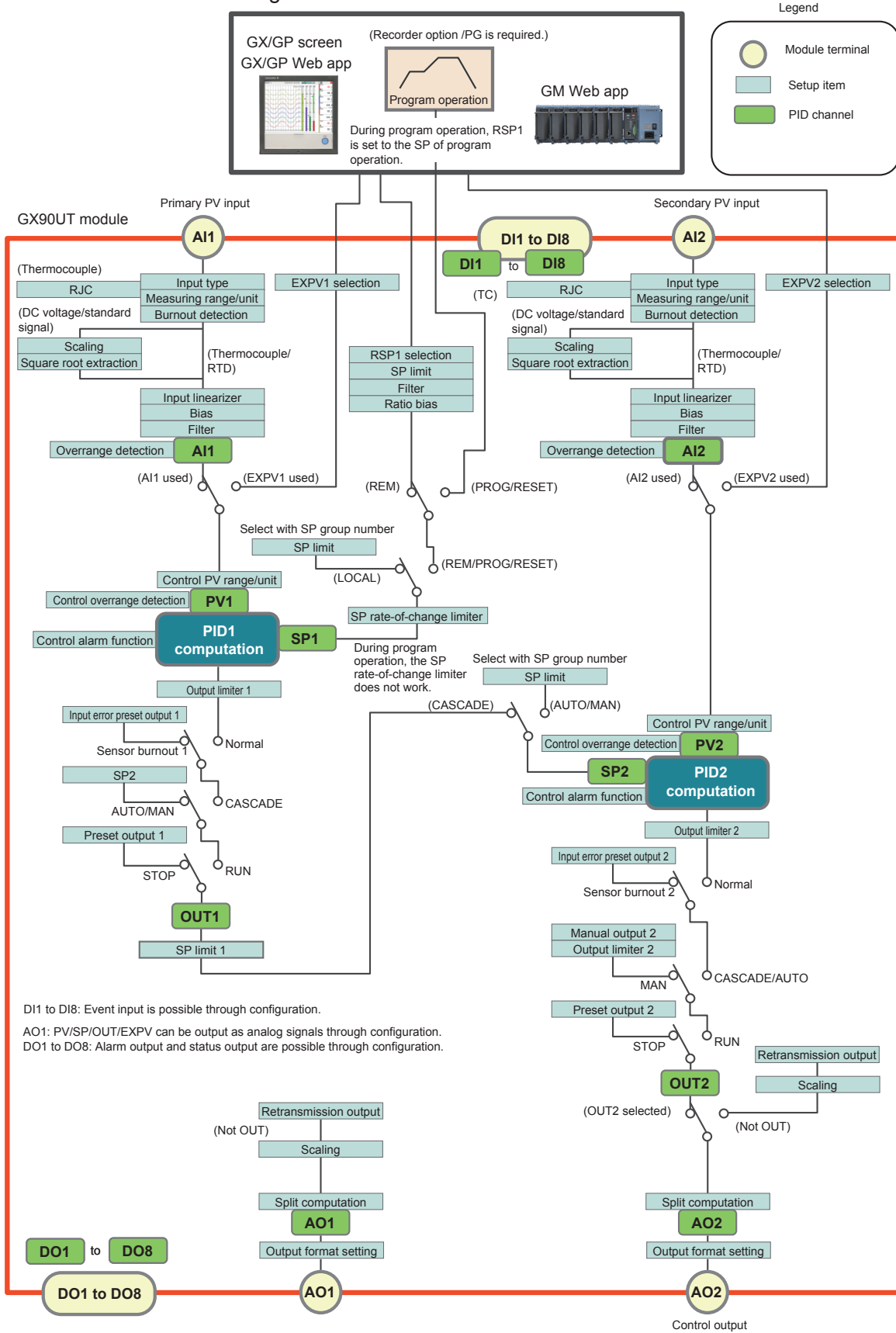

Loop Control with PV Switching Block Diagram

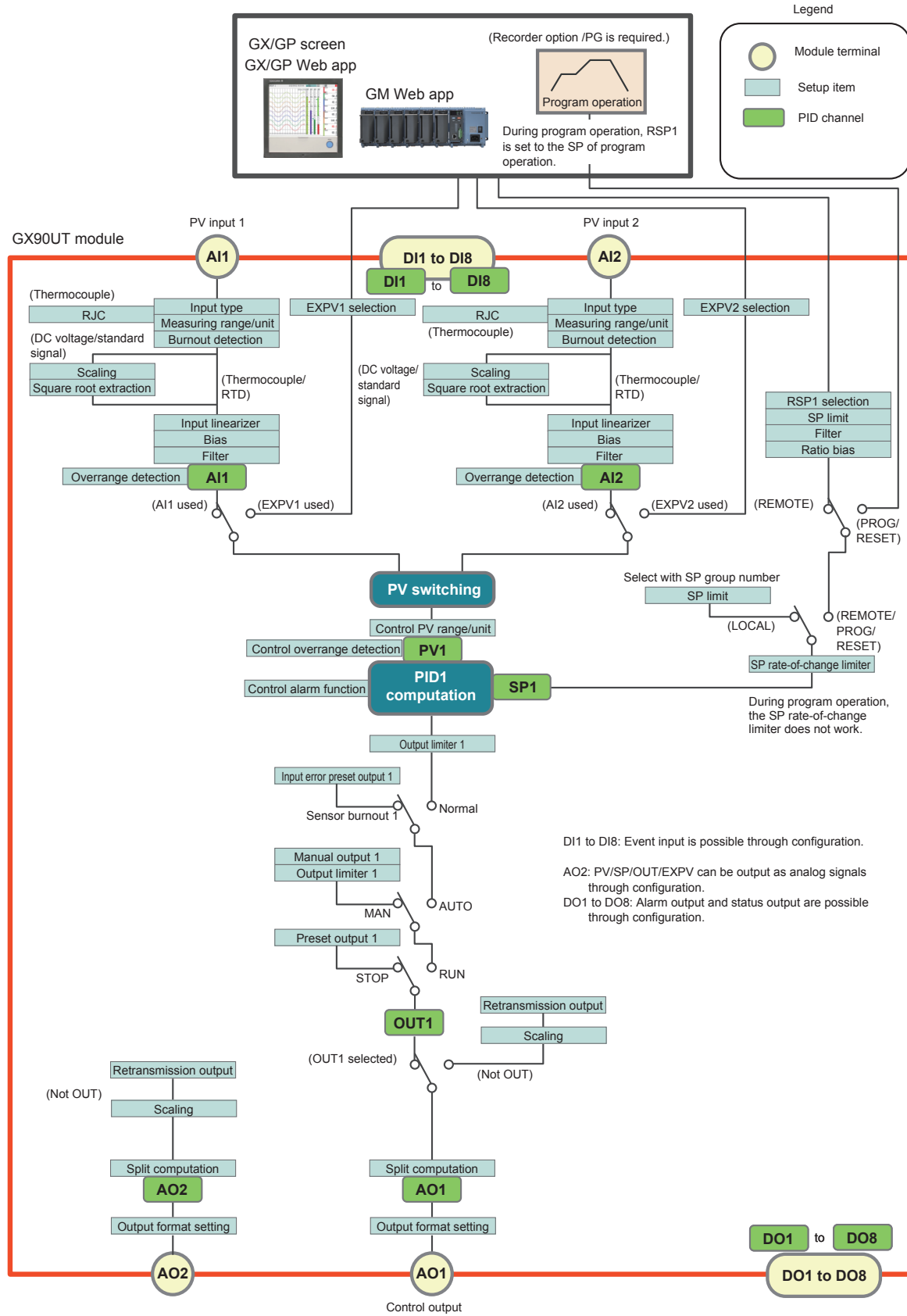

Loop Control Function (Function of the GX/GP/GM Main Unit)

This function can be used when a PID Control Module is installed in GX/GP main unit, expandable I/O, GM main unit, or sub unit.

Control Screen

Display update interval (GX/GP): 500 ms (fixed)

On the GM, a Web application is used to perform operations similar to those performed on the GX/GP main unit's screen.

Control Group Screen

Multiple loops can be shown as a group (control group) on a single screen.

Controller style: A screen that emphasizes PV values as on a digital indicating controller

Display items: Tag No., tag string, operation mode, operating status, control alarm status, PV value, PV unit string, deviation status, SP value, OUT value, OUT unit string, error display

Faceplate style: A screen that shows control values graphically.

Display items: Same items shown on the controller style display as well as PV scale high and low limits, bar graph of PV value, PV alarm high and low limit marks, bar graph of OUT value, SP pointer



Control Group Screen

Number of Control Groups and Number of Loops That Can Be Registered

Model	Number of Groups (max.)	Number of Loops (max.)/Group
GX10/GP10	5	6
GX20-1/GP20-1 (standard type)	5	8
GM10-1 (standard type)	5	8
GX20-2/GP20-2 (large memory type)	10	8
GM10-2 (large memory type)	10	8

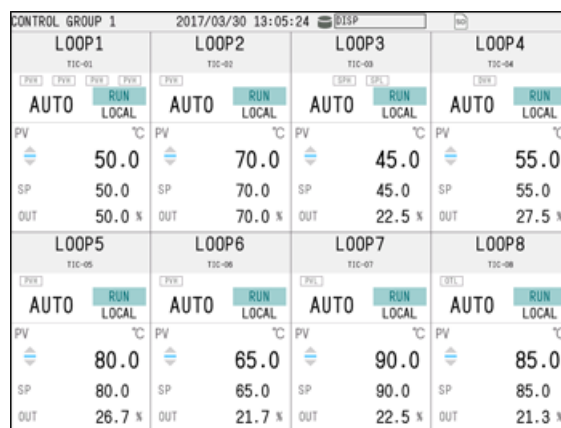

Controller style display example

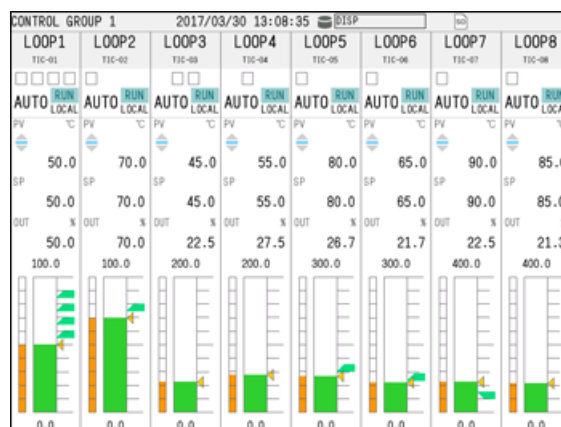

Faceplate style display example

Control Overview Screen

The control overview screen shows on a single screen the alarm status of all loops.

When an alarm occurs, the background color turns red and the text color white.

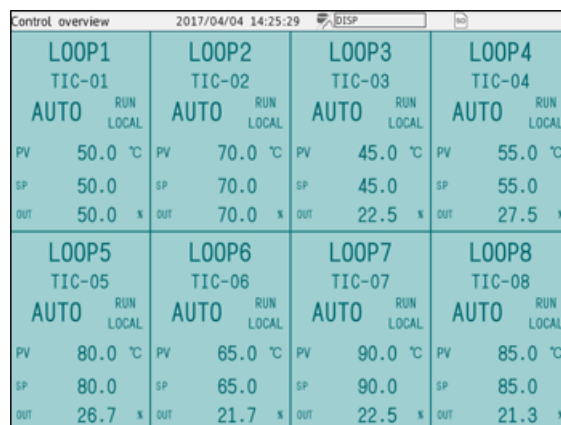

Tuning Screen

The tuning screen can be used to set or adjust PID constants and the like while viewing process data during operation.



Control Summary Screen

The control summary screen shows a history of control operations (run/stop, auto/manual, etc.). You can select a historical entry and jump to the historical trend of that section.

- Displayed contents: name, status, time
- Maximum number of summaries: 1000 (if the maximum number is exceeded, the oldest event is deleted)

UP	DOWN	Name	Status	Time
		LOOP7	RUN	2017/03/30 12:36:03
		LOOP3	AUTO	2017/03/30 12:36:00
		LOOP7	STOP	2017/03/30 12:35:37
		LOOP3	MANUAL	2017/03/30 12:35:24
		LOOP8	RUN	2017/03/30 11:08:19
		LOOP8	AUTO	2017/03/30 11:08:18
		LOOP7	RUN	2017/03/30 11:08:15
		LOOP7	AUTO	2017/03/30 11:08:14
		LOOP6	RUN	2017/03/30 11:08:11
		LOOP6	AUTO	2017/03/30 11:08:10
		LOOP5	RUN	2017/03/30 11:08:08

Control Alarm Summary Screen

The control alarm summary screen shows a history of control alarms. You can select a historical entry and jump to the historical trend of that section.

- Displayed contents: loop, level, type, time
- Maximum number of summaries: 500 (if the maximum number is exceeded, the oldest event is deleted)

UP	DOWN	Loop	Level	Type	Alarm time
		LOOP4	2	DVH	2017/03/30 12:18:33.730
		LOOP4	2	DVH	2017/03/30 11:56:10.730
		LOOP4	2	DVO	2017/03/30 11:45:37.130
		LOOP4	2	DVO	2017/03/30 11:45:13.430
		LOOP7	1	PVL	2017/03/30 11:40:55.130
		LOOP8	1	OTL	2017/03/30 11:40:09.230
		LOOP8	1	OTL	2017/03/30 11:39:55.830
		LOOP4	2	DVL	2017/03/30 11:39:30.330
		LOOP7	1	PVL	2017/03/30 11:39:30.230
		LOOP7	1	PVL	2017/03/30 11:39:30.110
		LOOP4	2	DVL	2017/03/30 11:36:09.330

Multi Panel Screen

You can assign a control group screen, control overview screen, control alarm summary screen, and control summary screen to the multi panel screen.

The control group screen and control overview screen may not be displayed depending on the size of the multi panel area that they are assigned to.

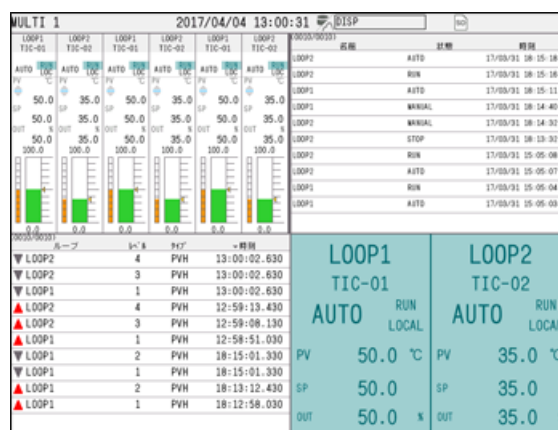

Favorite and Standard Screens

Control screens can be registered to favorite and standard screens.

Background Color

The background color of control screens can be set to white or black.

(Controller style display example)

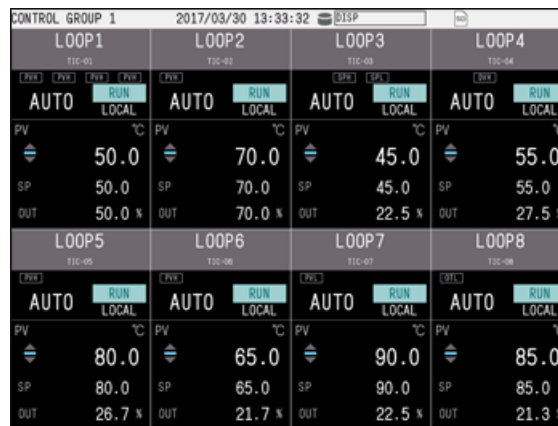

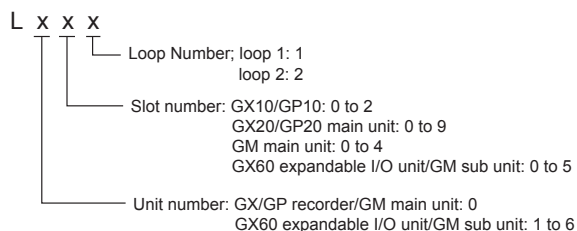
Loop Number:**Tag:**

Tag strings and tag numbers can be assigned to loop numbers.

- Tag string: up to 32 characters
Displayable characters: English, Japanese, and Chinese characters
- Tag No.: up to 16 characters
Displayable characters: Alphanumeric and symbols

PID Channel:

PID channels are used to display control data and I/O data of PID control modules on trend or digital displays and save the data as recorded data.

- PID channel:
analog input (AI1/AI2), digital input (DI1 to DI8), analog output (AO1/AO2), digital output (DO1 to DO8), control data (PV1/PV2, SP1/SP2, OUT1/OUT2)
- PID channel recording interval: depends on the recorder's recording interval

PID Channel Display Settings:

tag, color, zone, scale, bar graph

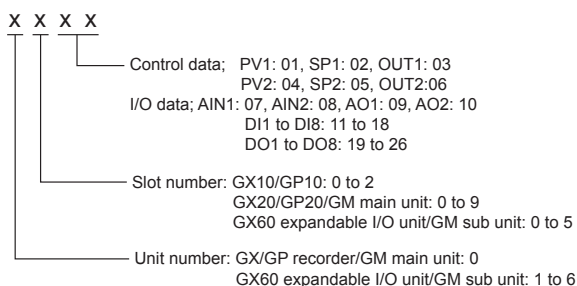
**Number of PID Channels:**

The number of channels of the GX90UT module is 26 (fixed).

When choosing the type of GX / GP / GM main unit (Standard / Large memory), please calculate it as 26 channels per one unit.

Control Functions**Control Mode**

Select from single loop control, cascade control, and loop control with PV switching

- * Two single loops can run on a single unit. (Dual-loop control is possible.)

Number of Control Loops

2 loops/ module (single loop control×2, cascade control)

1 loop/module (loop control with PV switching)

- GX/GP/GM system (standard type): 6 loops max.
- GX/GP/GM system (large memory type): 20 loops max.

Control Period (Input Sampling Period)

100 ms or 200 ms (system global setting)

Control Computation Function

- Control type: PID control, on/off control
- Target setpoint (SP): up to 8 per loop
- PID parameter: 8 groups/loop
- PID parameter group selection:
Using target setpoint numbers (SPNO) (PID numbers can be assigned as you like) or segment PIDs (during program control)
Using PV input zones (zone PIDs)*
Using target setpoint zones (zone PIDs)*
Using final target setpoint zones (zone PIDs)*
Externally (using the contact input)
* If the deviation exceeds the reference deviation setpoint during constant preset control, the PID constant switches automatically to the preset PID parameter group.

- Zone PID switches: 7 max.
- PID default setting function: The controlled target can be set to a PID constant suitable for the temperature or that suitable for the pressure or flow rate.
- PID control mode:
fixed-point control mode or constant preset control
- SP limiter function: A high limit or low limit can be set.
- SP ramp rate setting function: A rising ramp rate or falling ramp rate can be set.
- Tracking function:
SP tracking, PV tracking
- Auto-tuning function
- "Super" function (overshoot-suppressing function)
- Anti-reset windup (over-integration prevention function)
- Preset function (when operation is stopped)
- Input error preset function

Operation Mode Switching

Remote/local (R/L), auto/manual (A/M), run/stop (R/S), cascade/auto/manual (CAS/AUTO/MAN), auto tuning (AT) run/stop

Control Parameter Setting Range

- Proportional band (P): 0.0 to 999.9%
- Integral time (I): 0 to 6,000 s
- Derivative time (D): 0 to 6,000 s
- ON/OFF control hysteresis: 0.0 to 100.0% of measuring range (high and low can be set separately)
- Preset output value: -5.0 to 105.0%
- Output limiter setting range: -5.0 to 105.0% (limiter low limit < limiter high limit)
- Normal/reverse operation switching: normal or reverse
- Tight shut function: When manual control is carried out with 4 to 20 mA output, control output can be reduced to about 0 mA.
- Rate-of-change limiter of output: Off or 0.1 to 100.0%/s

External PV (EXPV)

External PV can be turned on and off. An I/O, math, or communication channel can be assigned to PV. EXPV send period: 100ms to 500ms (depends on the system configuration.)

Remote SP (RSP)

Remote SP can be turned on and off. An I/O, math, or communication channel or the analog input of a PID control module can be assigned to SP. A filter and ratio bias can be set on the remote SP. Remote SP send period: 100ms to 500ms (depends on the system configuration.)

Retransmission Output (Analog Retransmission) Function

Output function: current output (reverse output possible)
PV, SP, or OUT can be retransmitted from analog output.

Math Function

CP computation (zirconia O₂ sensor electromotive force, CO₂ partial pressure), special CLOG.AVE computation, magic number

- * The math function is a recorder option (/MT). For details, see the general specifications of the GX/GP/GM recorder.

Alarm Function

- Control alarm types
PV high limit, PV low limit, SP high limit, SP low limit, deviation high limit, deviation low limit, deviation high and low limits, deviation within high and low limits, control output high limit, control output low limit, PV rate-of-change
- Alarm action
Standby action, relay action (hold/nonhold, reset on ACK, normal action on ACK), hysteresis, ON-delay timer, Off-delay timer
- Number of alarm setpoints: 4 per loop
- Standby action
Turns off alarms from the start of control (power-on) until a stable condition is reached.
- Hysteresis: Hysteresis can be set for each alarm setting.
- Display: status display in the digital display area when an alarm occurs. Common alarm display can be switched between hold and nonhold.

Other Functions

- Recorder operation
Operation
Operation security settings

Control Event Action

Control action or status output can be performed using DI, DO, and internal switch.

- Action

All loop control operation start
All loop control operation stop
Control operation start/stop (specified loop)
Auto/manual switch (specified loop)
Remote/local switch (specified loop)
Auto switch (specified loop)
Manual switch (specified loop)
Cascade switch (specified loop)
Remote switch (specified loop)
Local switch (specified loop)
Hold operation
Advance operation
Program operation start
Program operation stop
Program operation mode change
Hold operation (specified loop, specified program pattern)
Advance operation (specified loop, specified program pattern)
Program operation start (specified loop, specified program pattern)
Program operation stop (specified loop, specified program pattern)
Pattern number switch (BIN, BCD)

- Status output
 - Notification during control operation
 - Segment number (BIN, BCD)
 - Pattern number (BIN, BCD)
 - PROG/RESET monitoring
 - Wait end signal (1s, 3s, 5s)
 - Pattern end signal (1s, 3s, 5s)
 - PV event status
 - Time event status
 - Wait flag
 - Hold-on flag

■ Program Control Function (/PG GX/GP/GM recorder option)

With the program control function, a PID control module installed in the GX/GP main unit, expandable I/O, GM main unit or sub unit can control a system according to time varying setpoints sent from the GX/GP/GM main unit.

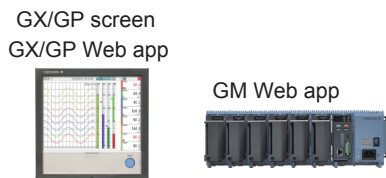

(Recorder option /PG is required.)

Program patterns are executed by operating the GX/GP or GM recorder or Web app.

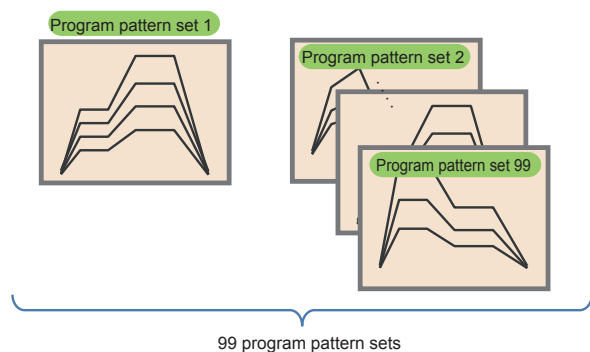

- Number of program pattern sets: 99
- Program pattern name: up to 20 characters
- Number of segments: 99 segments/pattern
- Number of simultaneous execution: 1 pattern only
- SP update period: 100 to 500 ms (depends on the system configuration)
- PV events:
 - PV alarms, deviation alarms, and the like in program patterns
 - Maximum number of events: 32 per segment
 - Type: PV high limit, PV low limit, SP high limit, SP low limit, deviation high limit, deviation low limit, deviation high and low limits, deviation within high and low limits, control output high limit, control output low limit
- Time event:
 - Status output is possible according to the progress of program patterns.
 - Maximum number of events: 32 per segment
 - Time setting: 0 to (segment time - 1 s)
- Operation mode switching:
 - Program run/reset, hold/release hold, advance execute, local operation
- Number of pattern repetitions:
 - 999 max. or infinite
- Segment time:
 - 0 hours 0 minutes 1 second to 99 hours 59 minutes 59 seconds

- Program pattern start/stop:
 - Program pattern start, stop, hold, and advance can be controlled from digital input, communication, or recorder's screen.
- Program pattern selection:
 - can be controlled from digital input, communication, or recorder's screen.
- Advance function: forcibly moves to the next segment
- Wait function:
 - Wait time:
 - off, 0 hours 0 minutes 1 second to 99 hours 59 minutes 59 seconds
 - Wait zone: 0.0 to 10.0% of PV range span
- Hold function: available
- PID parameter switching:
 - Segment PID switching:
 - PID parameter number can be switched for each segment.
 - Zone PID switching:
 - PID parameters can be switched using PV values and the like.
- Status output through digital output (control event action)
 - Status monitoring is possible using digital output.
 - Program pattern number monitoring,
 - program end (pattern end) notification,
 - segment number monitoring, operation mode monitoring (PROG/REST), wait end notification, PV/time event notification, waiting notification, holding notification, local operation

Program Selection Screen

The program selection screen is for selecting the program pattern to start operations and viewing pattern settings.

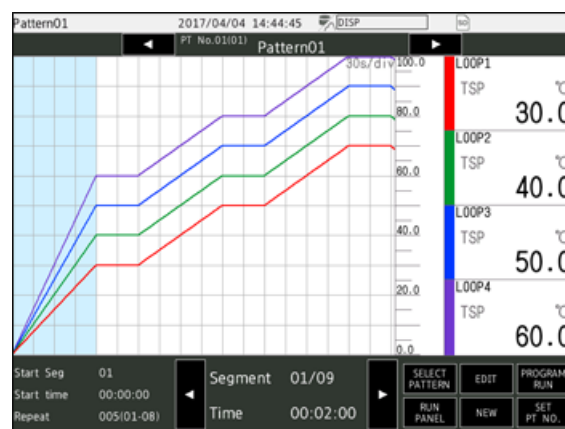

- Program screen display:
 - Program operation status display screen:
 - displays the program operating status and the current PV simultaneously (GX/GP only)
 - Number of display loops: 20 max.
 - Number of screens: 1
 - Display update interval:
 - Digital display area: 500 ms fixed
 - Trend display area: according to the trend interval
 - Program event display: possible

Program Operation Screen

The program operation screen is for displaying the program pattern that is currently running.

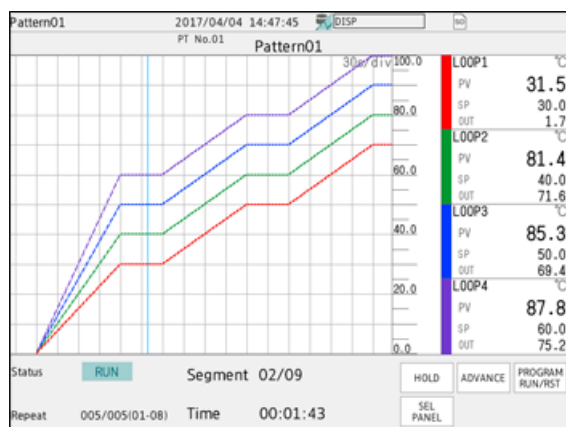

- Other recorder operations:
 - Save each program pattern to file
 - Load program patterns
 - Delete program patterns

Control Data Acquisition/Recording Function (GX/GP/GM recorder function)

- Acquires/records control data (PV, SP, OUT, etc.)
 - Acquisition/recording is possible by installing a PID Control Module and reconfiguring the system.
 - PID channel data can be used as an I/O channel to be saved in data files or used in computation and reports.
- Control operation summary (number of saved files: up to 3000 data values, number of display data values: up to 1000 data values)
- Control alarm summary (number of saved files: up to 1000, number of display data entries: up to 500)

Installation Conditions

Systematic PID Control Module Limitations

GX/GP/GM system (Standard type)	Max. 3 devices
GX/GP/GM system (Large memory type)	Max. 10 devices

However, if the system includes PID control modules (GX90UT), digital output modules (GX90YD), and digital input/output modules (GX90WD), the maximum total number of these modules is 10.

If the recorder's measurement operation mode is high speed or dual interval, PID control modules will not work. (For details, see the general specifications of the GX/GP/GM recorder.)

Input/Output Module Limitations on Recorders and Units When Using the PID Control Module

GX10/GP10 recorder (Standard type)	Max. 3 devices* Note:
GX20/GP20 recorder (Standard type)	Max. 8 devices*
GX20/GP20 recorder (Large memory type)	Max. 8 devices*
GM single unit configuration, main (standard type)	Max. 5 devices*
GM single unit configuration, main (large memory type)	Max. 5 devices*
GM multi unit configuration, main (standard type)	Max. 5 devices*
GM multi unit configuration, main (large memory type)	Max. 5 devices*
GX60 expandable I/O	Installable within the system limitations
GM multi unit configuration, sub unit	Installable within the system limitations

* This is the number of devices including the expansion modules (GX90EX) installed in the GX/GP/GM recorder when an expandable I/O unit (GX60) or GM sub unit is used.

Note: The maximum number is 2 when the GP10 supply voltage is 12 VDC.

■ Model and Suffix Codes

Model and Suffix Codes (GX90UT)

Model	Suffix code			Description
GX90UT				PID Control Module
Number of loops	-02			2 loops
Function		-11		DI 8 points, DO 8 points
-		N		Always N
Terminal type			-3	Screw terminal (M3)
Region			N	General

■ Optional Accessories (Sold separately)

Name	Type
Shunt resistor for current input (for M3 screw terminal) ($250 \Omega \pm 0.1\%$)	415940
Shunt resistor for current input (for M3 screw terminal) ($100 \Omega \pm 0.1\%$)	415941
Shunt resistor for current input (for M3 screw terminal) ($10 \Omega \pm 0.1\%$)	415942

Calibration Certificate (Sold separately)

When you order PID control modules, each module gets its own calibration certificate.

Test Certificate (QIC, sold separately)

When you order PID control modules, each module gets its own QIC.

User's Manual

You can download the product user's manuals from the following URL. You will need Adobe Reader 7 or later (latest version recommended) by Adobe Systems.

URL: www.smartdacplus.com/manual/ja/

■ Basic Conditions and Individual Contracts at the Time of Purchase

The warranty for this product is defined in the basic conditions and individual contracts at the time of purchase. The individual conditions are as follows.

- Validation**
 Yokogawa does not guarantee the final outcome of validation work even if there is a defect in the product.
 For the warranty of validation services, please contact the company that performed the validation work.
- Warranty period of the firmware**
 The firmware warranty period is one year.
 Please refer to the following URL for the procedure to update the firmware and the method to download the firmware.
<https://myportal.yokogawa.com/>

Trademarks

The TCP/IP software used in this product and the document for that TCP/IP software are based in part on BSD networking software, Release 1 licensed from The Regents of the University of California. SMARTDAC+ is a registered trademark or trademark of Yokogawa Electric Corporation.

Microsoft, MS, and Windows are trademarks or registered trademarks of Microsoft Corporation in the United States and other countries.

Pentium is a registered trademark of Intel Corporation.

Modbus is a registered trademark of AEG Schneider. Other company names and product names appearing in this document are registered trademarks or trademarks of their respective holders.

The company and product names used in this manual are not accompanied by the registered trademark or trademark symbols (® and ™).

General Specifications

GS 04L53B00-01EN

GX60
I/O Base Unit (Expandable I/O)
GX90EX
Expansion Module

SMARTDAC+TM

OVERVIEW

GX60 I/O Base Unit (Expandable I/O)

The GX60 provides a function to expand an I/O module for recording and controlling, when it is connected to the expansion module that is connected to the GX10/GX20/GP10/GP20/GM using a LAN cable via a private communication network.

- One GX60 can install up to six I/O modules.
- Up to six units can be additionally connected to the GX/GP/GM.
- The communication distance between the GX/GP/GM and GX60 or between GX60s can be extended by up to 100 m using a LAN cable.
- * When the measurement mode on the GX/GP/GM is High speed, expandable I/O units cannot be installed in the GX/GP/GM.

GX90EX Expansion Module

The expansion module is installed in the GX10/GX20/GP10/GP20, GX60, GM main unit, and GM sub unit.

[If GX90EX expansion module is installed in the GX/GP or I/O base unit]

- The expansion module, which is supported by the GX/GP and GX60, enables a connection between GX/GP and GX60 or a communication between GX60s.
- A distributed arrangement with the data time synchronization secured is provided by connecting Expansion modules installed in the GX/GP main unit and GX60 using a LAN cable.
- Data is transferred to the high-order GX/GP via the expansion module.

[If GX90EX expansion module is installed in the GM main unit/sub unit]

- The expansion module, which is supported by the GM main unit and sub unit, enables a connection between GM main unit and sub unit or a communication between sub units.
- A distributed arrangement with the data time synchronization secured is provided by connecting Expansion modules installed in the GM main unit and sub unit using a LAN cable.
- Data is transferred to the high-order GM10 via the expansion module.

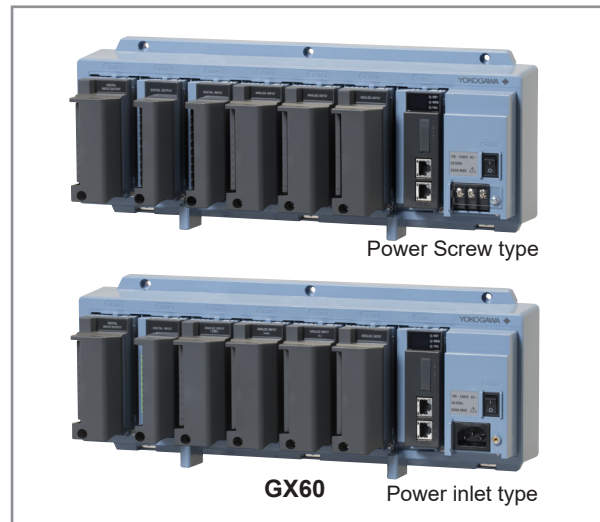

■ GX60 SPECIFICATIONS

Module Installation

- I/O module: Max. 6 modules (Slots 0 to 5)

Modules that can be installed
Please refer to the General Specifications of the GX90XA/GX90XD/GX90YD/GX90WD/GX90XP/GX90YA I/O Modules (GS 04L53B01-01EN) and GX90UT PID cControl Module (GS 04L53B01-31EN).

Restrictions:

Expansion module: 1 module (expansion module slot "EXT")

For other limitations, see the GX10/GX20 Paperless Recorder (Panel Mount Type) General Specifications (GS 04L51B01-01EN).

Names of Channels

- The module installed in the GX60 has a channel name that consists of the unit number, slot number, and channel number.

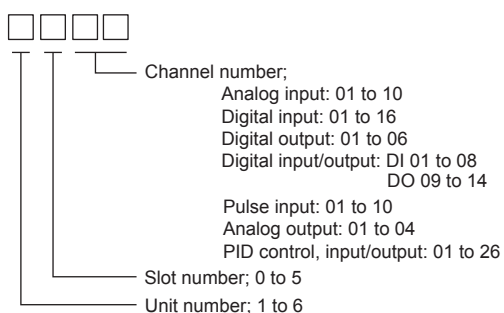
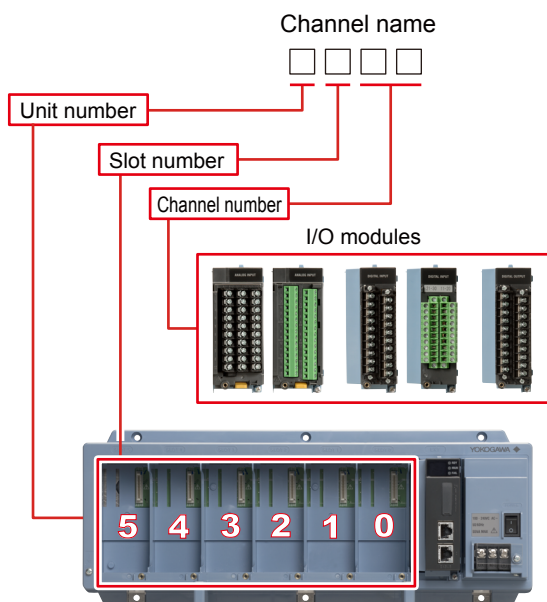

Safety and EMC Standards

- CSA:
 - CSA C22.2 No. 61010-1,
 - CSA-C22.2 No. 61010-2-030,
 - CAN/CSA-C22.2 No.61010-2-201^{*4},
 - Overvoltage Category II^{*1}, Pollution Degree 2^{*2},
 - Measurement Category^{*3}
- UL:
 - UL 61010-1, UL Std. No. 61010-2-030,
 - UL 61010-2-201^{*4} (CSA NRTL/C),
 - Overvoltage Category II^{*1}, Pollution Degree 2^{*2},
 - Measurement Category^{*3}
- CE, UKCA/EMC directive:
 - EN 61326-1 Class A Table 2 (For use in industrial locations) compliant
 - EN 61000-3-2 compliant
 - EN IEC 61000-3-2 compliant
 - EN 61000-3-3 compliant
 - EN 55011 Class A Group 1 compliant
- CE, UKCA/Low voltage directive:
 - EN 61010-1, EN IEC 61010-2-030,
 - EN IEC 61010-2-201^{*4} compliant
 - Overvoltage Category II^{*1}, Pollution Degree 2^{*2},
 - Measurement Category^{*3}
- CE, UKCA/EU RoHS directive: EN IEC 63000
- WEEE Directive: Compliant
- EMC Regulatory Arrangement in Australia and New Zealand (RCM): EN 55011 Class A Group 1 compliant
- KC marking: KS C9811, KS C9610-6-2 compliant

*1 Overvoltage Category II:

Describes a number which defines a transient overvoltage condition. Implies the regulation for impulse withstand voltage.

"II" applies to electrical equipment which is supplied from the fixed installation like a distribution board.

*2 Pollution Degree 2:

Describes the degree to which a solid, liquid, or gas which deteriorates dielectric strength or surface resistivity is adhering.

"2" applies to normal indoor atmosphere.

Normally, only non-conductive pollution occurs.

*3 Measurement Category:

Depends on the specification of each modules.

*4 This product is designed as open equipment

under the relevant standard, install it as follows:

- Install the GX60 in a panel with a door.
- The instrumentation panel or panel used for support must comply with CSA/UL/EN/IEC 61010-2-201 or must be at least IP1X (degrees of protection) and at least IK09.

Construction

- Front panel (terminal): Water and dust-proof, Complies with IEC529-IP20
- Material: Polycarbonate, aluminum alloy
- Color;
Bezel: Smoke blue (Munsell 4.1PB6.0/4.5 equivalent)
- Dimensions: 412.5 mm(W) x 164.7 mm(H) x 127.8 mm(D)
- Weight: Approx. 3.2 kg (installing 6 modules)

Power Supply

- Rated supply voltage: 100 to 240 VAC
- Allowable power supply voltage range: 90 to 132, 180 to 264 VAC
- Rated power supply frequency: 50/60 Hz
- Power consumption:

Supply voltage	Normal operation *	Maximum
100 V AC	20 VA	40 VA
240 V AC	30 VA	55 VA

* When using 6 analog input modules.

- Allowable interruption time: Less than 1 cycle of the power supply frequency

Isolation

- Insulation resistance: Between each insulation terminals, and earth: 20 MΩ or greater at 500 VDC
- Withstand voltage:
Between the power terminal and earth: 3000 V AC at 50/60 Hz for one minute
Between the input/output modules and earth: Depends on the specification of I/O module.
- Grounding: Be sure to set a low grounding resistance.
- Isolation:

Power terminal	Input and output module terminal	
	Input and output module internal circuit	Internal circuit
	Earth (PE) terminal	

The circuits divided by lines are insulated mutually.

External Dimensions

Power screw terminal type

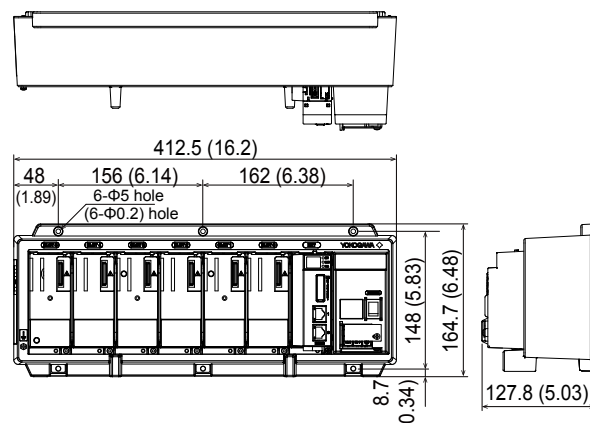

Power inlet type

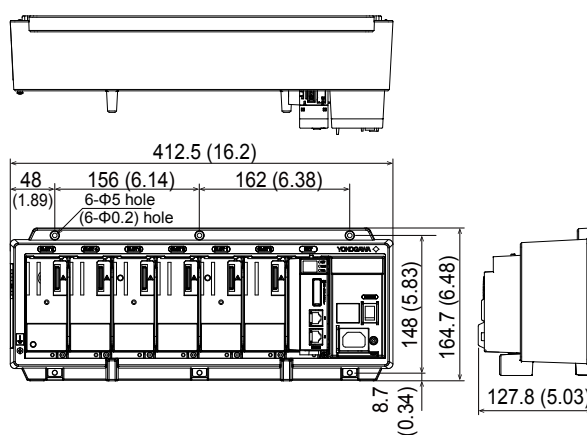

With modules

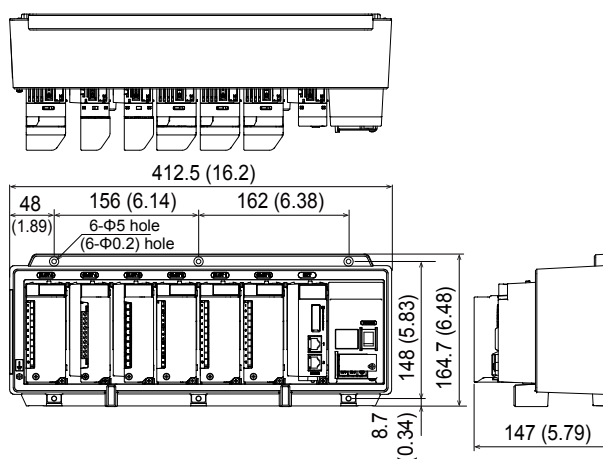

Dimensions of fixing hole

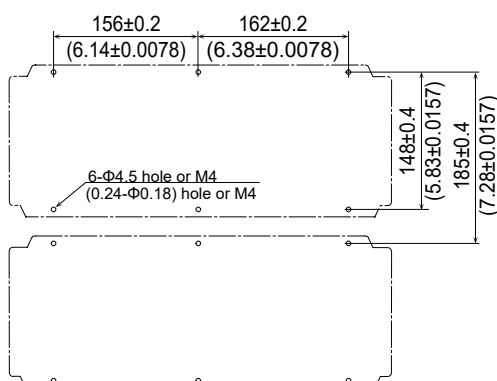

Unit: mm (approx. inch)

Unless otherwise specified, tolerance is $\pm 3\%$ (however, tolerance is ± 0.3 mm when below 10 mm).

Normal Operating Conditions

- Power supply voltage: 100 to 240 V AC $\pm 10\%$
- Power supply frequency: 50/60 Hz $\pm 2\%$
- Ambient temperature: 0 to 50 °C
- Ambient humidity: 20 to 80 %RH (However, less than moisture content of 40°C 80% RH at 40°C or more), No condensation
- Magnetic field: 400 A/m or less (DC and 50/60 Hz)
- Vibration:
 - $5 \leq f < 8.4$ Hz amplitude 3.5 mm (peak)
 - $8.4 \leq f \leq 160$ Hz acceleration 9.8 m/s² or less
- Shock (IEC-60068-2-27):
 - Non-energization, 500 m/s² or less, approximate 10 ms, 6 directions ($\pm X$, $\pm Y$, $\pm Z$)
- Mounting position: Can be inclined up to 30 degrees backward. Left and right horizontal when installing the panel mount and wall mount.
- Altitude: 2000 m or less
- Installation location: Indoors
- Warm-up time: At least 30 minutes after power on

Transport and Storage Conditions

- Ambient temperature: -25 to 60°C
- Ambient humidity: 5 to 95 %RH (no condensation)
- Vibration: 10 to 60 Hz, 4.9 m/s² maximum
- Shock: 392 m/s² maximum (in packaged condition)

Effects of Operating Conditions

- Power supply variation: Shall satisfy the accuracy specification in the range of 90 to 132 VAC or 180 to 250 VAC (frequency: 50/60 Hz). Power supply frequency fluctuation: Shall satisfy the accuracy specification in the range of rated supply frequency ± 2 Hz (power-supply voltage: 100 VAC).

■ GX90EX SPECIFICATIONS

Communication Functions

Communication between GX/GP and GX60, between GX60s, between GM main unit and sub unit, between GM sub units via dedicated communication network.

- Baud rate: 10Base-T/100Base-TX (Auto) *1
- Number of ports: 2
- Connection cable: STP cable, CAT5 or greater
- Inter-module connection: Cascade connection (Ring connection is disabled.)
- Maximum communication distance: 100 m *2
- Connector: RJ-45

*1 Can be fixed to 10Base-T by DIP switch settings.

*2 Distance extension through HUB connection or LAN repeaters is not possible.

Display Functions

- System status LED indicators:
 - RDY (green): Lights up when the CPU is running normally.
 - MAIN (green): Turns on in master mode and off in slave mode.
 - FAIL (red): Lights up when a system error occurs.
- 7-segment LED indicator: Indicates a unit number or operation error.
- Ethernet status indicator LED: LINK ACT (green), SPEED (orange)

Address Setting Functions

Switch settings:

Switch No.	Descriptions
1	For unit number setting
2	
3	
4	
5	-
6	-
7	10 Mbps/100 Mbps switching
8	MASTER/SLAVE switching

Master / Slave Functions

Can be set to master mode (when installed in the GX/GP or GM main unit), or slave mode (when installed in the GX60 or GM sub unit) using the DIP switches.

10 Mbps Fixed Mode

Can be set to the 10 Mbps fixed mode using the DIP switches.

Mounting

Can be mounted in the GX/GP, GX60, GM main unit, and GM sub unit.

- Mounting position:
 - GX10/GP10: Slot 2
 - GX20/GP20: Slot 9
 - GX60: EXT slot
 - GM main unit: Leftmost position
 - GM sub unit: Next to the power supply module

Safety and EMC Standards

- CSA:
CSA C22.2 No. 61010-1,
Overvoltage Category II or I^{*1}, Pollution Degree 2^{*2}
- UL:
UL 61010-1 (CSA NRTL/C),
Overvoltage Category II or I^{*1}, Pollution Degree 2^{*2}
- CE, UKCA/EMC directive^{*3}:
EN 61326-1 Class A Table 2 (For use in
industrial locations) compliant
EN 61000-3-2 compliant
EN IEC 61000-3-2 compliant
EN 61000-3-3 compliant
EN 55011 Class A Group 1 compliant
- CE, UKCA/Low voltage directive^{*3}:
EN 61010-1 compliant,
Overvoltage Category II or I^{*1}, Pollution Degree 2^{*2}
- CE, UKCA/EU RoHS directive^{*3}: EN IEC 63000
- WEEE Directive: Compliant
- EMC Regulatory Arrangement in Australia and
New Zealand (RCM): EN 55011 Class A Group 1
compliant
- KC marking: KS C9811, KS C9610-6-2 compliant

- *1 Overvoltage Category:
Describes a number which defines a transient
overvoltage condition.
Implies the regulation for impulse withstand
voltage.
II or I depends on the power supply specification
of the GX/GP main unit, GM main unit or sub unit.
- *2 Pollution Degree 2:
Describes the degree to which a solid, liquid,
or gas which deteriorates dielectric strength or
surface resistivity is adhering.
"2" applies to normal indoor atmosphere.
Normally, only non-conductive pollution occurs.
- *3 The CE, UKCA standards for modules represent
standards that are met when the module is
installed in the main unit.

Construction

- Front panel (terminal): Water and dust-proof,
Complies with IEC529-IP20
- Material: Polycarbonate
- Color;
Front: Charcoal grey light (Munsell 10B3.6/0.3
equivalent)
Bezel: Smoke blue (Munsell 4.1PB6.0/4.5
equivalent)
- Dimensions: 45.2 mm(W) x 111 mm(H) x 107.1
mm(D) (D: including terminal cover)
- Weight: Approx. 0.18 kg

Power Supply

- Supply from GX/GP, GX60 expandable I/O, or
GM90PS power supply module.
- Power consumption: 1.8W or less

External Dimensions

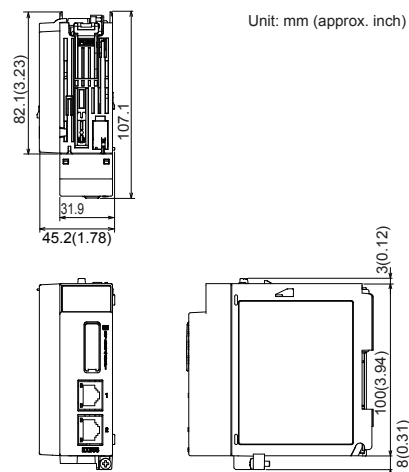

Normal Operating Conditions

For normal operating conditions of this module,
please refer to the General Specifications of the
device (GX/GP, I/O Base Unit, or GM) that this
module is mounted.

GX Specifications: GS 04L51B01-01EN

GP Specifications; GS 04L52B01-01EN

I/O Base Unit (Expandable I/O): This General
Specifications

GM Specifications: GS 04L55B01-01EN

Transport and Storage Conditions

- Ambient temperature: -25 to 70°C
- Ambient humidity: 5 to 95 %RH (no
condensation)
- Vibration: 10 to 60 Hz, 4.9 m/s² maximum
- Shock: 392 m/s² maximum (in packaged
condition)

Effects of Operating Conditions

None

■ MODEL AND SUFFIX CODES

MODEL and SUFFIX Code (GX60)

Model	Suffix Code			Description
GX60				I/O Base Unit
Type	-EX			I/O Expansion
Area		N		General
Power supply			1	100 V AC, 240 V AC
Power cord			D	Power cord UL/CSA standard
			F	Power cord VDE standard
			R	Power cord AS standard
			Q	Power cord BS standard
			H	Power cord GB standard
			N	Power cord NBR standard
			W	Screw terminal (M3)

* One GX90EX (I/O expansion module) is provided.

MODEL and SUFFIX Code (GX90EX)

Model	Suffix Code			Description
GX90EX				I/O Expansion Module
Port	-02			2 ports
Type		-TP1		Twisted Pair Cable
-			N	Always N
Area			-N	General

■ Standard Accessories

Product	Qty
Power cord	1*
Stopper (Antiskid rubber) (A9088ZM)	2

* Except GX60 power cord suffix code: W

■ Optional Accessories (Sold Separately)

The dummy cover is for empty slots on GX/GP and GX60. The dummy cover is not attached to the GX60 when shipped from the factory. If you need the dummy cover, please purchase it separately.

Product	Part no.
Dummy cover	B8740CZ

Test certificate (QIC, sold separately)

When ordering the GX60, GX90EX gets its own QIC (one QIC per unit).

When ordering the expansion modules separately, each module gets its own QIC (one QIC per module).

User's Manual

Product user's manuals can be downloaded or viewed at the following URL. To view the user's manual, you need to use Adobe Reader 7 or later by Adobe Systems.

URL: www.smartdacplus.com/manual/en/

■ Basic Conditions and Individual Contracts at the Time of Purchase

The warranty for this product is defined in the basic conditions and individual contracts at the time of purchase.

The individual conditions are as follows.

- **Validation**
Yokogawa does not guarantee the final outcome of validation work even if there is a defect in the product.
For the warranty of validation services, please contact the company that performed the validation work.
- **Warranty period of the firmware**
The firmware warranty period is one year.
Please refer to the following URL for the procedure to update the firmware and the method to download the firmware.
<https://myportal.yokogawa.com/>

Trademarks

The TCP/IP software used in this product and the document for that TCP/IP software are based in part on BSD networking software, Release 1 licensed from The Regents of the University of California.

- SMARTDAC+ is a registered trademark or trademark of Yokogawa Electric Corporation.
- Microsoft, MS and Windows are registered trademarks of Microsoft Corporation USA.
- Pentium are registered trademarks of Intel Corporation.
- Modbus is a registered trademark of AEG Schneider.
- Other company and/or product names are registered trade mark of their manufactures.

Blank

General Specifications

GX90NW
Network Module

SMARTDAC+TM

GS 04L53B51-01EN

OVERVIEW

A network module is a module that is mounted on the GX10/GX20, GP10/GP20, or GM main unit.

It enables the use of various industrial communications protocols.

- Its modular structure allows you to add various protocol modules to easily carry out communication.

NETWORK MODULE SPECIFICATIONS

Type: PROFINET (Model: GX90NW-02-PN)



FUNCTIONAL SPECIFICATIONS

Communication Specifications

- **PROFINET Specifications**
 - Type: PROFINET IO - Device
 - Conformance Class: B
 - Support for cyclic and acyclic communication
 - PROFINET communication settings are entered using a configurator and DCP protocol-enabled free tools (such as PRONETA).
The settings include the following.
 - Device name
 - IP address, subnet mask, and default gateway

Communication Functions

PROFINET supports cyclic and acyclic communications.

With cyclic communication, after PROFINET is configured, data is exchanged automatically.

With acyclic communication, data can be accessed and controlled by using a ladder program.

- **Cyclic Communication**
 - Data update intervals: 100 ms, 200 ms, 500 ms, 1 s, 2 s, 5 s, 10 s
 - Available channels:

Channel type	Model	Available channels
Input/Output	GX10/GP10	0001 to 0010, 0101 to 0110
	GX20/GP20/GM10	0001 to 0010, 0101 to 0110, 0201 to 0210, 0301 to 0310, 0401 to 0410
Math ¹	GX10/GP10 GX20/GP20/GM10	A001 to A050
Communication ²	GX10/GP10	C001 to C020
	GX20/GP20/GM10	C001 to C050

- 1 With the Mathematical (/MT) option.
 - 2 With the Communication Channel (/MC) option.
- Readable data: Measured values on input/output and computation channels.
Status of each communication channel.
 - Writable data: Communication channel measurements.
 - **Acyclic Communication**
 - Available channels: All I/O channels except those on expansion units, all computation channels (/MT), and all communication channels (/MC)
 - Readable data: Measurements and statuses from all channel types
 - Writable data: Measurements from communication channels, and output values from AO and DO channels
 - Control: The following control operations are available:
 - Record start/stop
 - Perform computation
 - Write messages
 - Read/Write batch information
 - Read/write alarm settings
 - Alarm ACK
- Note The following are not available: Read control alarm status, read/write control alarm settings, and output control alarm ACK.

■ HARDWARE SPECIFICATIONS

Communication Port

Ethernet port:

- Baud rate: 10BASE-T/100BASE-TX (Auto)
- Number of ports: 2 ports
- MDI: MDI/MDI-X (Auto)
- Connection cable: STP cable, CAT5 or greater
- Maximum communication distance: 100 m
- Connector: RJ-45

PROFINET port:

- Baud rate: 100BASE-TX full duplex
 - Number of ports: 2 ports
 - MDI: MDI/MDI-X (Auto)
 - Connection cable: PROFINET compatible cable*
- * For details, see the PROFINET cable guidelines published by "PROFIBUS and PROFINET International".
- Maximum communication distance: 100 m
 - Connector: RJ-45

Display Functions

- System status LEDs:
 - RDY (green): CPU normal
 - ACT (green): PROFINET normal
 - FAIL (red): System abnormal
- Ethernet status LEDs:
 - Upper side (orange): SPEED (ON = 100 Mbps, OFF = 10 Mbps)
 - Lower (green) : ON = Link, Flashing = Communication
- PROFINET status LEDs:
 - Network Status LED (green, red):
 - Green = communicating with controller,
 - Flashing red = PROFINET communication settings not entered
 - Module Status LEDs (green, red):
 - Green = Normal, Red = Abnormal
 - Port1, Port2 Link/Activity LED (green):
 - ON = Link, Flashing = Communication

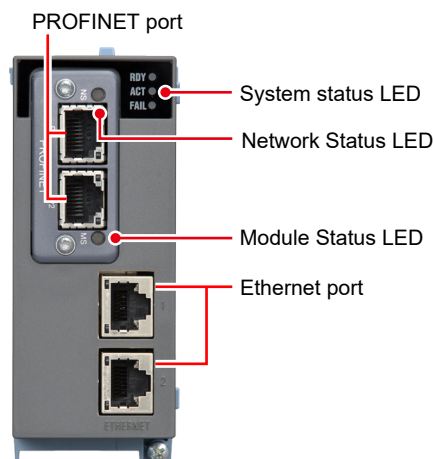

Module Installation

Mount modules on the GX/GP or GM main unit.

- * The GX90NW cannot be used for the GX60, GM sub unit.

To enable Modbus communication, use an Ethernet cable to connect the GX/GP or GM10 general-purpose Ethernet port to the network module's Ethernet port.

Data is transferred to the GX/GP main unit or GM10 via the network module.

Mounting position:

Model	Mounting position
GX10/GP10	SLOT 2
GX20/GP20	SLOT 9
GM10	Leftmost position when facing the front of the main unit.

Connections: Connect an Ethernet cable from the GX/GP or GM10 general-purpose Ethernet port to the network module's Ethernet port.

A cable of 1 m or shorter is recommended.

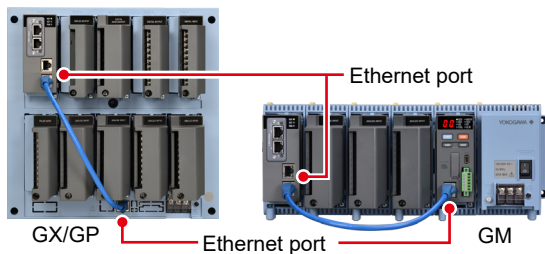

Restrictions when mounting modules

When the GX90NW is mounted, there are restrictions for GX90NW and other modules.

For restrictions, see the specifications of the unit (GX/GP or GM) on which the module is installed.

GX10/GX20 General Specifications:

GS 04L51B01-01EN

GP10/GP20 General Specifications:

GS 04L52B01-01EN

GM General Specifications:

GS 04L55B01-01EN

Safety and EMC Standards

- CSA:
 - CSA C22.2 No. 61010-1,
 - Overvoltage Category II or I^{*1}, Pollution Degree 2^{*2}
- UL:
 - UL 61010-1 (CSA NRTL/C), Overvoltage Category II or I^{*1}, Pollution Degree 2^{*2}
- CE, UKCA^{*3}:
 - EMC directive:
 - EN 61326-1 Class A Table 2 (For use in industrial locations) compliant
 - EN 61000-3-2 compliant
 - EN IEC 61000-3-2 compliant
 - EN 61000-3-3 compliant
 - Low voltage directive:
 - EN 61010-1 compliant, Overvoltage Category II or I^{*1}, Pollution Degree 2^{*2}
 - EU RoHS directive: EN IEC 63000
- WEEE directive: Compliant

- EMC Regulatory Arrangement in Australia and New Zealand (RCM): EN 55011 Class A Group 1 compliant
- KC marking: KS C9811, KS C9610-6-2 compliant
- PROFINET: IEC 61158, IEC 61784

- *1 Overvoltage Category: Describes a number which defines a transient overvoltage condition. Implies the regulation for impulse withstand voltage. Applies to electrical equipment which is supplied from the fixed installation like a distribution board. II or I depends on the power supply specification of the main unit.
- *2 Pollution Degree 2: Describes the degree to which a solid, liquid, or gas which deteriorates dielectric strength or surface resistivity is adhering. "2" applies to normal indoor atmosphere. Normally, only non-conductive pollution occurs.
- *3 The CE, UKCA standards for modules represent standards that are met when the module is installed in the main unit.

Construction

- Front panel (terminal): Water and dust-proof, Complies with IEC529-IP20
- Material: Polycarbonate
- Color;
 - Front: Charcoal grey light (Munsell 10B3.6/0.3 equivalent)
 - Bezel: Smoke blue (Munsell 4.1PB6.0/4.5 equivalent)
- Dimensions: 45.2 mm (W) x 111 mm (H) x 110.4 mm(D)
- Weight: Approx. 0.3 kg

Power Supply

Supply from GX/GP or GM90PS power supply module.

- Power consumption: 3.3 W or less

Isolation

Insulation resistance: 500 VDC 20 MΩ or greater between RJ-45 connector and grounding terminal*

- * Grounding terminals are connected to the GX/GP or GM system

RJ-45 connector (Ethernet port 1)	Internal circuit
RJ-45 connector (Ethernetport 2)	
RJ-45 connector (PROFINET port 1)	
RJ-45 connector (PROFINET port 2)	

————— Functional insulation

External Dimensions

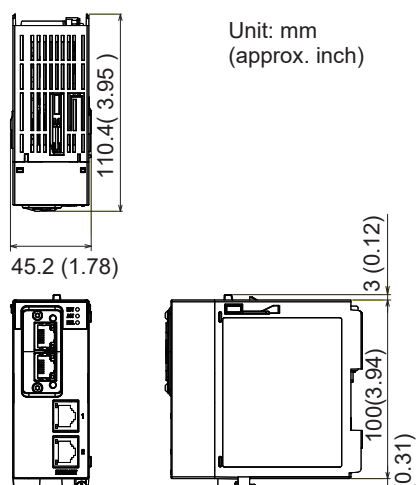

Normal Operating Conditions

For normal operating conditions of this module, please refer to the General Specifications of the device (GX/GP or GM) that this module is mounted.

GX General Specifications: GS 04L51B01-01EN

GP General Specifications: GS 04L52B01-01EN

GM General Specifications: GS 04L55B01-01EN

Transport and Storage Conditions

- Ambient temperature: -25 to 70°C
- Ambient humidity: 5 to 95 %RH (no condensation)
- Vibration: 10 to 60 Hz, 4.9 m/s^2 maximum
- Shock: 392 m/s^2 maximum (in packaged condition)

Effects of Operating Conditions

Nothing

■ MODEL AND SUFFIX CODES

MODEL and SUFFIX Code (GX90NW)

Model	Suffix Code				Description
GX90NW ¹					Network Module
Number of ports	-02				2 ports
Type	-PN				PROFINET
-		N			Always N
Terminal form			-R		RJ-45 connector
Area				N	General

1 The GX90NW cannot be used for the GP10 12 VDC power supply model (power supply voltage suffix code: 2).

Test certificate (QIC, sold separately)

When ordering network modules, each type gets its own QIC (one QIC per module type).

User's Manual

Product user's manuals can be downloaded or viewed at the following URL. To view the user's manual, you need to use Adobe Reader 7 or later by Adobe Systems.

URL: www.smartdacplus.com/manual/en/

■ Basic Conditions and Individual Contracts at the Time of Purchase

The warranty for this product is defined in the basic conditions and individual contracts at the time of purchase.

The individual conditions are as follows.

- **Validation**
Yokogawa does not guarantee the final outcome of validation work even if there is a defect in the product. For the warranty of validation services, please contact the company that performed the validation work.
- **Warranty period of the firmware**
The firmware warranty period is one year.
Please refer to the following URL for the procedure to update the firmware and the method to download the firmware.
<https://myportal.yokogawa.com/>

Trademarks

The TCP/IP software used in this product and the document for that TCP/IP software are based in part on BSD networking software, Release 1 licensed from The Regents of the University of California.

- SMARTDAC+ is a registered trademark or trademark of Yokogawa Electric Corporation.
- Microsoft, MS, and Windows are registered trademarks or trademarks of Microsoft Corporation in the United States and/or other countries.
- Modbus is a registered trademark of AEG Schneider.
- Other company names and product names appearing in this document are registered trademarks or trademarks of their respective holders.

Blank